

N2 (UK) Ltd



Veterinary Supplies



VETERINARY

Instrument Catalogue

 www.n2-uk.com

 +44 (0)23 9323 3265

 @n2ukcom

 www.facebook.com/n2ukltd

 sales@n2-uk.com

 office@n2-uk.com for orders





Introduction

Welcome to Edition 4.1 of our instrumentation catalogue

As the veterinary market evolves our independent status has allowed us to quickly react to situations and maintain a high level of service to all our customers.

Our power tool options have grown to the point we have moved them out of this catalogue and into a stand alone capital equipment brochure which is available in paper or electronic versions.

We have added quite a few new products to our catalogue including a new arthroscopy section and have added to our premium storage section.

Now called the Victory range after the famous HMS Victory based in our home town of Portsmouth these offer unparalleled quality for your storage of our implants and kits.

We have maintained showing the products as drawings but keep your eyes on our website as we are continually updating it with high quality product images.

We have access to so many more products; please feel free to contact us if you can't see what you need. We are particularly popular with the peripatetic surgeons as well as site start-ups and can offer additional discounts and structured payment options to help you with larger orders.

We are now a stockist of the Johnson and Johnson Synthes range so please contact us if you would like more information on this.

We have also added a dedicated support email; n2.technical.advice@gmail.com predominantly for orthopaedics we use a trusted group of referral surgeons who can help advise on your upcoming procedures.



Andy Robinson Sales Director

Andy has been with the company for over 7 years now but has been key to the veterinary market for over 23 years building successful businesses and relationships wherever he goes.

The attraction of working and driving a privately owned UK based company was key to his decision to be 'Hands On' dealing with your needs and expectations.

Based centrally in Chesterfield, he is well positioned to meet any customer in any part of the country to show them first-hand the quality of our product range.

Andy has three children and a Bedlington Terrier and Pug/Maltese dog.

He brings an ethos to the company of treating every customer small or large equally and ensuring he is on hand to chat whenever convenient to our customers. Customer service is his top priority. Andy is also highly qualified in Purchasing and Supply, so he is well placed to help deal with the full supply chain from identifying the right products, quality control and meeting tough delivery requirements.



Andy says:

"It is a breath of fresh air to work with a group of people focussed on getting quality product out to customers when they need it. As an independently owned company we can react quickly to changing situations and tailor our response to the customer's needs rather than to shareholder's profits."

The fact that we manufacture all our implants ourselves in our own UK factory allows us to develop new products even when we know the market is limited.

The veterinary market has gone through many changes in my time but the fundamental part that keeps the industry going is the vets and nurses on the frontline. Our success is a promise to them that we will go that extra mile to ensure they receive a quality service and product at a fair price, something we are proud to contribute to."

Contents

	Page
Ortho and Joint	5-48
Arthroscopy	49-54
Drills and Taps	55-59
External Fixation	61-68
General Instruments	69-87
Dental	89-96
Ophthalmic	97-100
Kits and Storage	101-128
Standard Screws, Locking Screws, Drill Bits and Taps Chart	129
Procedure for Care and Maintenance of Stainless Steel Medical Instruments	130-131
Index	132-135

N2 (UK) Ltd
N2
Veterinary Supplies

UK manufactured

VETERINARY

Implant
Catalogue
for osteosynthesis

Spinnaker
TPLO

10
10 Years of Evolox®

www.n2-uk.com
+44 (0)23 9323 3265
@n2ukcom

www.facebook.com/n2ukltd
sales@n2-uk.com
office@n2-uk.com for orders



To order an Implant Catalogue
contact us on +44 (0)23 9323 3265





Cruciate Repair Line / Crimp / Needle

Cruciate repair surgery is one of the more common joint/orthopaedic procedures. We offer an option for most surgery types including below the simple Lateral Suture placement.

Below is a list of sterile monofilament packs we have available which does not need autoclaving.

We recommend using crimps against knot tying as these tend to be more atraumatic to the adjacent tissues.

Also available as Line and Crimp only.

Order Code	Description
CR-L-50	50lb Single Nylon Line 500mm
CR-L-80	80lb Single Nylon Line 800mm
CR-L-100	100lb Single Nylon Line 800mm

Sterile line and Crimp packs with Swaged on Needle.

Order Code	Description
CR-LCN-50	50lb Single Nylon with Swaged on 30mm Needle and 10mm Crimp
CR-LCN-80	80lb Single Nylon with Swaged on 45mm Needle and 12mm Crimp
CR-LCN-100	100lb Single Nylon with Swaged on 62mm Needle and 12mm Crimp

Sterile Double line and Swaged on Needle packs.

Order Code	Description
CR-LCN-50-DBL	50lb Double Nylon with Swaged on 30mm Needle and 2 x 10mm Crimps
CR-LCN-80-DBL	80lb Double Nylon with Swaged on 45mm Needle and 2 x 12mm Crimps
CR-LCN-100-DBL	100lb Double Nylon with Swaged on 62mm Needle and 2 x 12mm Crimps

Sterile Double line and Crimp packs with Swaged on Needle packs.

Order Code	Description
CR-LN-50-DBL	50lb Double Nylon with Swaged on 30mm Needle
CR-LN-80-DBL	80lb Double Nylon with Swaged on 45mm Needle
CR-LN-100-DBL	100lb Double Nylon with Swaged on 62mm Needle

Non sterile spare Crimps.

Order Code	Description
CR-CRIMP-10	Cruciate Repair Spare 10mm Crimp For use with 50 LB line
CR-CRIMP-12	Cruciate Repair Spare 12mm Crimp For use with 80 and 100 LB lines

Weights	
50lb used for <12kgs	100lb for 35>kg
80lb used for <20kgs	100lb Double used for 35kg+

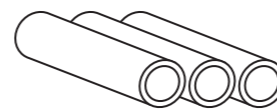
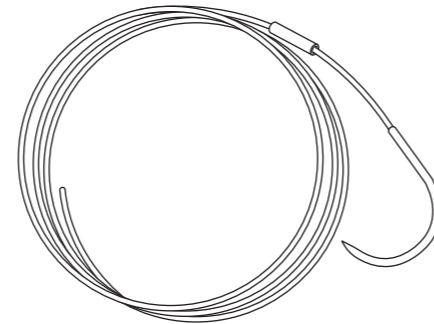
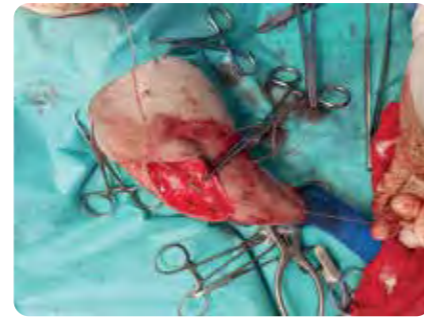

E-Fiber UHMWPE

Ultra High Molecular Weight Polyethylene

E-FIBER is a medical grade braided sterile surgical suture prepared from Ultra High Molecular Polyethylene (UHMWPE) and Polyester. E-Fiber is a non-absorbable, braided suture that provides flexibility and strength superior to most other suture materials.

Benefits

- ✓ High purity, medical grade Ultra-High-Molecular-Weight-Polyethylene fiber provides flexibility and unmatched strength.
- ✓ Unique braided construction has a superior shearing strength than polyester suture with a long chain polyethylene core.
- ✓ Lubricious design allows each knot to slide for smoother, more efficient performance.
- ✓ A flatter surface allows each knot to lock against the previous, providing superior knot security.
- ✓ Unique braiding with a blue tracer provides improved visibility.

E-Fiber Lateral Suture Packs - Braided Surgical Suture.

Order Code	Description
EF-M5-NED-CR	E-Fiber Metric 5 300mm with Needles and Crimp
EF-M6-NED-CR	E-Fiber Metric 6 500mm with Needles and Crimp
EF-M7-NED-CR	E-Fiber Metric 7 500mm with Needles and Crimp
EF-M9-NED-CR	E-Fiber Metric 9 600mm with Needles and Crimp
EF-M9-NED-CR-DBL	E-Fiber Metric 9 500mm Double with Needles and Crimps

Order Code	Description
EF-M5-NED	E-Fiber Metric 5 300mm with Needles
EF-M6-NED	E-Fiber Metric 6 500mm with Needles
EF-M7-NED	E-Fiber Metric 7 500mm with Needles
EF-M9-NED	E-Fiber Metric 9 600mm with Needles
EF-M9-NED-DBL	E-Fiber Metric 9 500mm Double with Needles

Order Code	Description
EF-M5-500	E-Fiber Metric 5 500mm
EF-M6-500	E-Fiber Metric 6 500mm
EF-M7-500	E-Fiber Metric 7 500mm
EF-M9-600	E-Fiber Metric 9 600mm

Recommended sizes are as follows -		Tensile strength	
Metric 5 E-Fiber	<10kgs	Metric 5 E-Fiber	250lbs
Metric 6 E-Fiber	10-20kgs	Metric 6 E-Fiber	330lbs
Metric 7 E-Fiber	20-30kgs	Metric 7 E-Fiber	370lbs
Metric 9 E-Fiber	30-40kgs	Metric 9 E-Fiber	410lbs
Metric 9 Double Length	>40kgs		

Recommended crimp sizes
USP 2> 10mm crimp
USP 3+4 and USP 5> 12mm crimp
USP 7> 14mm crimp

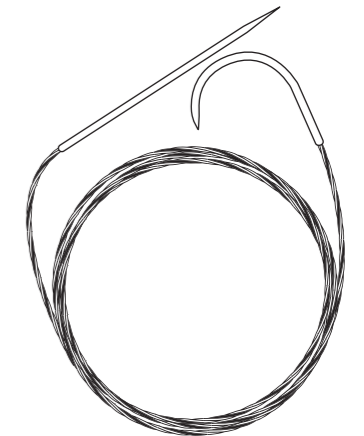

Toggles

Used with the Cruciate systems. Hip toggles provide an effective way to surgically stabilise and manage traumatic luxations of the coxo-femoral joint. The toggle allows a monofilament leader line to be anchored to the medial aspect of the acetabulum, mimicking the action of the round ligament, thus restoring joint stability.

Order Code	Description
HIP-TOG-25	2.5mm Hip Toggle
HIP-TOG-30	3.0mm Hip Toggle

Ormrod Buttons



These titanium buttons are ideal for preventing suture from rubbing directly on the bone.

Order Code	Description
ORM-BUT-06-SL	Titanium Ormrod Button 6mm Slotted
ORM-BUT-06-HL	Titanium Ormrod Button 6mm with Hole
ORM-BUT-09-SL	Titanium Ormrod Button 9mm Slotted
ORM-BUT-09-HL	Titanium Ormrod Button 9mm with Hole
ORM-BUT-11-SL	Titanium Ormrod Button 11mm Slotted
ORM-BUT-11-HL	Titanium Ormrod Button 11mm with Hole

Crimping Forceps

A selection of crimping forceps to suit every budget.

Order Code	Description
FC-CR-CA	Crimping Forceps Compound Action
FC-C-TC	Crimping Forceps with T.C. Tips
FC-C-STD	Crimping Forceps 190mm

-  ✓ Correct. Three evenly spaced crimps
-  ✗ Incorrect. Not enough crimps
-  ✗ Incorrect. Crimps too near to the end of the tube

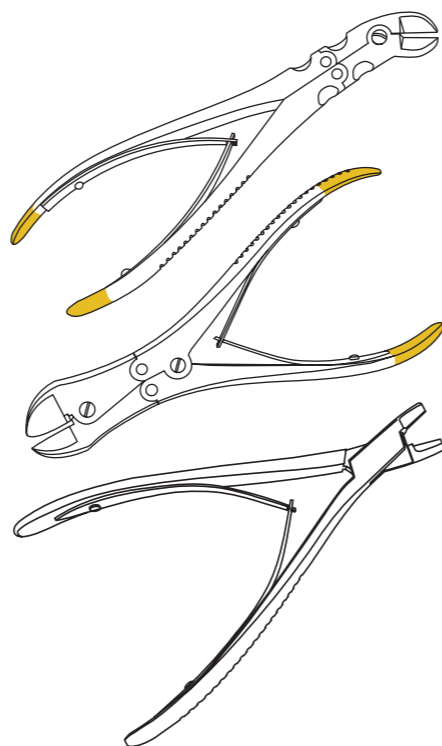
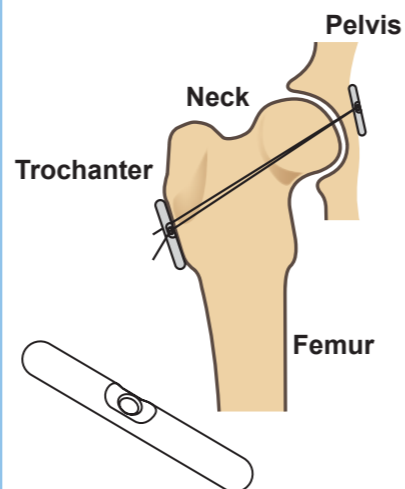

Bone Tunnel Borer

Used to tunnel through the tibial tunnel.

Order Code	Description
BT-BOR-20	Bone Tunnel Borer 2.0mm
BT-BOR-25	Bone Tunnel Borer 2.5mm
BT-BOR-27	Bone Tunnel Borer 2.7mm
BT-BOR-35	Bone Tunnel Borer 3.5mm
CS-BTB-UV	Bone Tunnel Borer Countersink - Universal

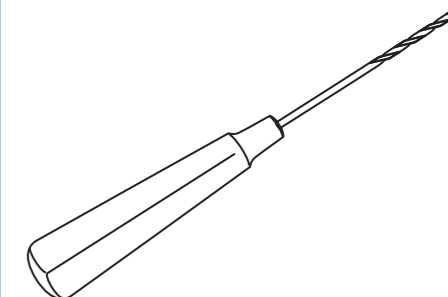

Graft Passer

Curved Graft Passer is required when using the 'over the top technique' to help pull the graft through the stifle joint. When drilling hole allow enough space for material to be dragged through as well.

Order Code	Description
GP-XS	Graft Passer - Extra Small
GP-S	Graft Passer - Small
GP-L	Graft Passer - Large
GP-XL	Graft Passer - Extra Large

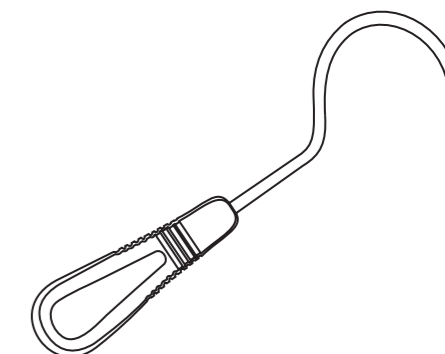

Straight Graft Passer is useful for pulling the graft through bone tunnels. When drilling hole allow enough space for material to be dragged through as well.

Order Code	Description
GP-STR	Graft Passer - Straight

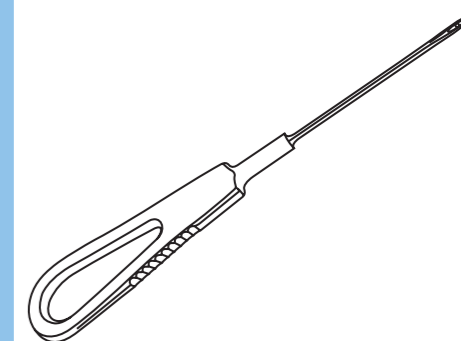

Suture Tensioning Forceps

Used with a Gelpi to pull the line tight. For Gelpis see page 17.

Order Code	Description
LT-TENS	Lateral Suture Tensioning Device

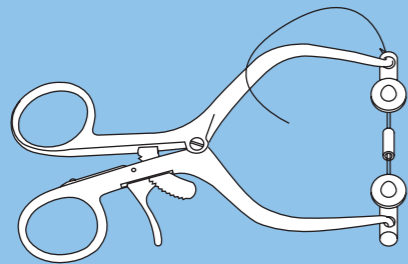

Stand alone instrument to add tension to line. Requires two extra crimps to add the tension to the line. For crimps see page 6.

Order Code	Description
LT-TENS-FCP	Lateral Suture Tensioning Forcep

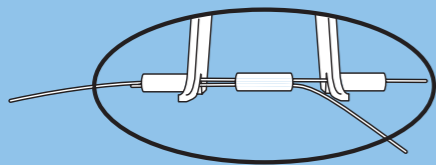

Used to grasp the needle and pass it through the cruciate allowing more force to be exerted than a standard needle holder.

Order code	Description
ND-HD-20	Heavy Duty Needle Holder with T.C. Tips

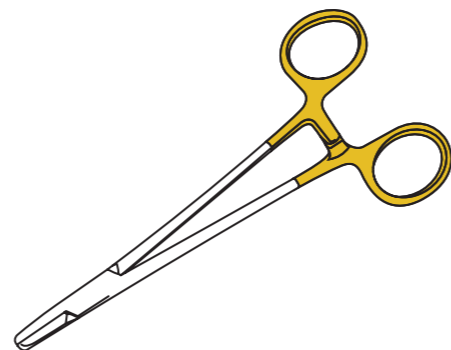
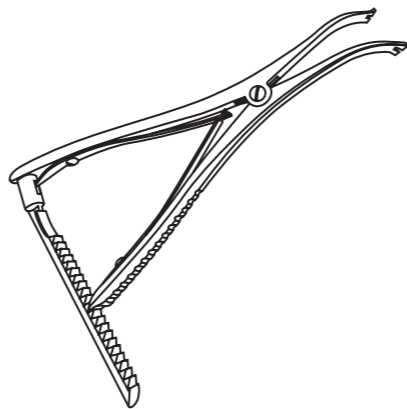
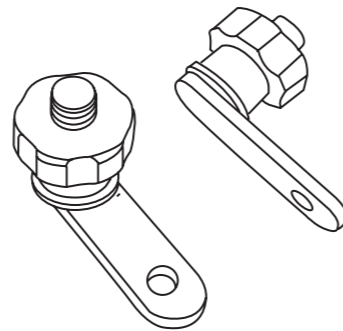

TPLO Instruments

For TPLO plates see page 162 in the implant catalogue.

Holds the fragments of the tibia in place until the radial cut has been secured, a 2.5mm hex screwdriver is required for the jig lug screws.

Order Code	Description
TPLO-JIG	TPLO Jig Standard 3.2mm
TPLO-JIG-SM	TPLO Jig Small 2.4mm

Can be adjusted from 0-20mm to help set the distance to rotate the tibial plateau.

Order Code	Description
RG-TPLO-CAL	TPLO Rotation Calipers

Made in stainless steel, a useful guide to help with osteotomies in conjunction with the Rotation Chart.

Order Code	Description
RG-TPLO-SET	TPLO Rotation Gauge

Used to aid marking and cutting of wedge.

Order Code	Description
WG-TPLO-SET	TPLO Wedge Set

Has a very sharp point on both ends that easily marks the bone to aid cutting and also rotation. Ideal for marking your TPLO rotation landmarks.

Order Code	Description
BS-20	Bone Scribe 200mm

Provides the rotation data for all the TPLO blades from 12-34mm as well as a handy drill and screw chart. Finger grooves aid surgeon using intra-operatively.

Order Code	Description
RG-TPLO-ROT-CH	TPLO Rotation Chart - Titanium

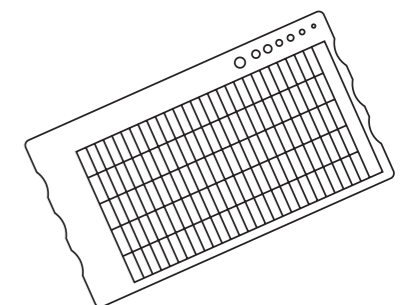
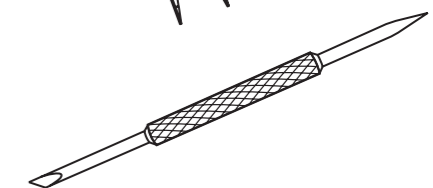
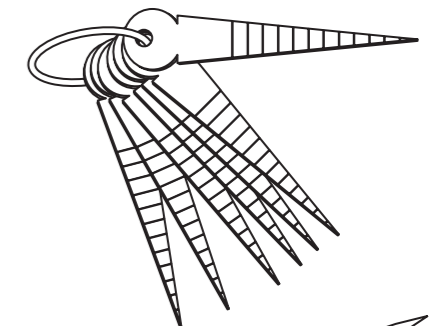
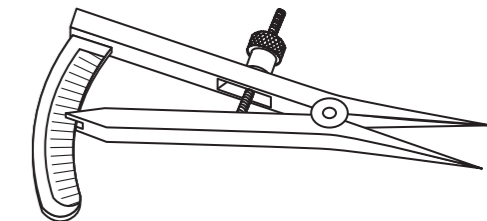
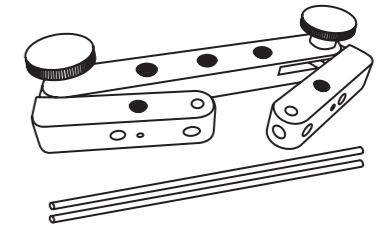

Plate Spacer Sets

Order Code	Description
2724-SP-SET	Set of 10 Spacers for 2.4/2.7mm Plates (pack contains various sizes)
35-SP-SET	Set of 10 Spacers for 3.5mm Plates (pack contains various sizes)

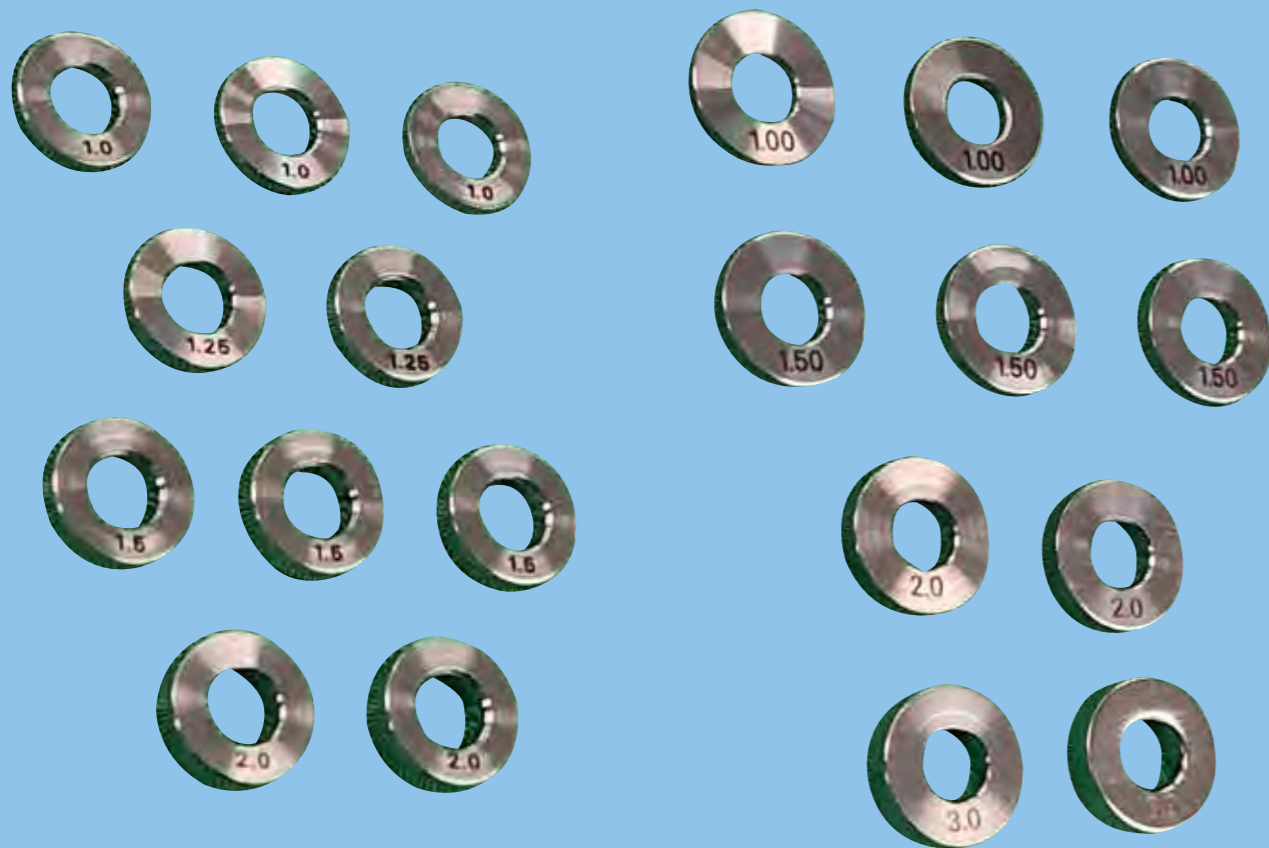

Plate Spacer Sets

Veterinary Supplies



Order Code	Description
2724-SP-SET	Plate Spacer Set for 2.7/2.4mm Plate - Pack 10 (1mm - 2mm)
35-SP-SET	Plate Spacer Set for 3.5mm Plate - Pack 10 (1mm - 3mm)

For those awkward bone flares and shapes it's sometimes difficult to fully contour the plate to the bone. Our Evolox® OS plate system helps reduce this problem with its plate flexibility and screw angulation but sometimes a large straight plate is needed where plate flexibility is reduced such as a TPLO plate.

Leaving a large gap between plate and bone when under tension can result in extra pressure being placed on the screw head.

We have released a simple solution to this.

Made from the same material (ISO-5842-1) as our implants to remove the chance of Galvanic Corrosion. We offer two sets of washers in 3.5mm and 2.4/2.7mm. Each set comprises 10 washers of varying thicknesses which allows you to slip the washer under the plate to give a more stable foundation and remove some of the stress from the screw. The variations in washer sizes allows lots of choice dependent on gap size, with the added flexibility to stack washers on top of each other to create further height options

Mark Bush MA VetMB CertSAS DSAS(O) MRCVS, RCVS Diplomate in Small Animal Orthopaedic Surgery, RCVS Recognised Specialist in Small Animal Orthopaedic Surgery had the following to say on the use of washers.

"I have used washers in the past in this situation, perhaps not a huge number of times, but nowadays I tend to burr bone of the proximal fragment until I can get the plate to fit without having this tilt, as this also risks placing the screw into the joint. I do use washers in all my PCAs however, as I place them at the radiocarpal screw hole under the plate to stop the RCB from being pulled too dorsally when the screw is tightened. If I don't do this, I have found that as the RCB moves dorsally, the contact with the distal radius can be significantly reduced resulting in a smaller surface area for arthrodesis which risks failing if the plate ever must be removed. I have attached two images, one with and one without washers, to show the effect on the radiocarpal bone/distal radial arthrodesis site."



- 🌐 www.n2-uk.com
- ☎ +44 (0)23 9323 3265
- ✉ @n2ukcom
- 📘 www.facebook.com/n2ukltd
- ✉ sales@n2-uk.com
- 📦 office@n2-uk.com for orders



TTA Instruments

For TTA implants see page 181 of the implant catalogue.

Designed to grasp the TTA cage and place in the osteotomy gap.

Order Code	Description
TTA-CF	TTA Cage Forceps

TTA Osteotomy Saw Guide and Stopper

This easy to place saw guide allows a bespoke TTA osteotomy to be made while protecting the patellar ligament, simply by using the maquette hole (2 or 3mm) and a standard 1.6mm k-wire.

This guide allows you to accurately place a 2mm or 3mm maquette hole, ensuring that the tapering edges of your TTA osteotomy match those of your chosen width of TTA cage. Note: please see our TTA saw guide which slots perfectly into the maquette hole once drilled (compatible with both the 2mm and 3mm diameter maquette holes).

Order Code	Description
TTA-SAW-GUIDE	Saw Guide
TTA-OST-STOP-2	2mm Stopper
TTA-OST-STOP-3	3mm Stopper
TTA-SG-SET	Set of all above items

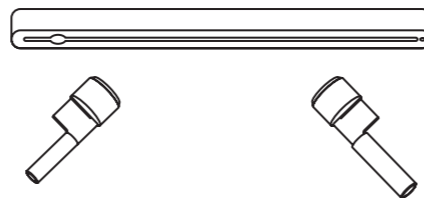
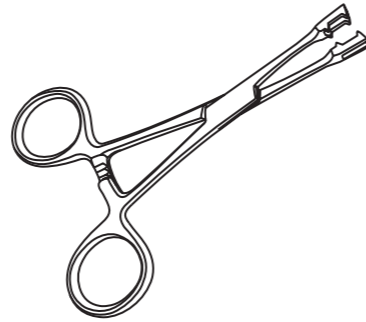

TTA Instruments cont.

The fine tips of the instrument are designed to cut TTA cages to the desired size.

Order Code	Description
CC-TTA-18	TTA Cage Cutter 180mm

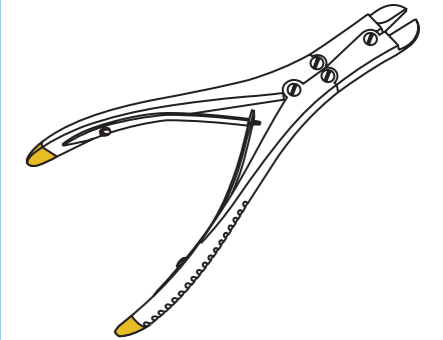

Thinner than our standard gauges make it ideal for working in the tibia.

Order Code	Description
TTA-DG	TTA Depth Gauge

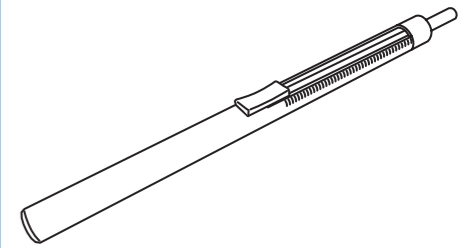

Designed to easily grab the thin plates from your kit.

Order Code	Description
TTA-FCP	TTA Forcep

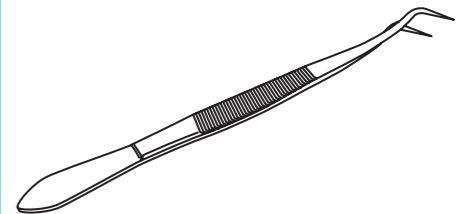

Dedicated bender for the plates.

Order Code	Description
TTA-PB	TTA Plate Bender

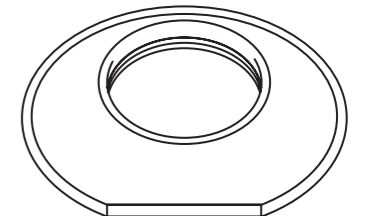

TTA Instruments cont.

For careful opening of osteotomy prior to cage placement.

Order Code	Description
TTA-SP-6	TTA Spreader 6mm
TTA-SP-9	TTA Spreader 9mm
TTA-SP-12	TTA Spreader 12mm

TTA Instrument Set

Order Code	Description
TTA-SET	Discounted against individual parts the set comprises of TTA Guide, Forceps, Plate Bender and Screwdriver Handle

Order Code	Description
TTA-HDL	TTA Handle

TTA Kit in box available. Contact us for more information.

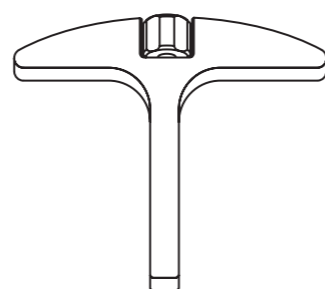
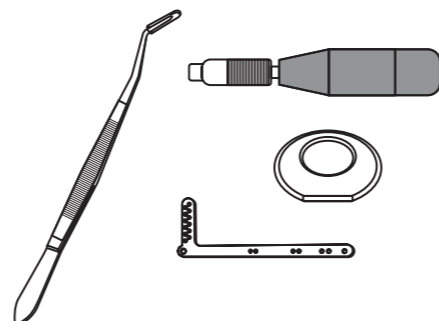
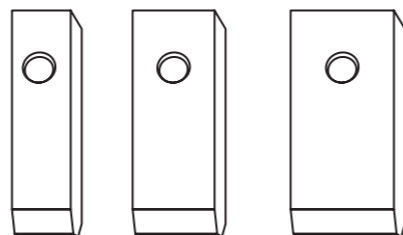

Retractor - Gelpi

N2 carry 3 types of Gelpi retractor; curved, curved long reach, and straight long reach.

Straight refers to the shaft being straight and in-line with the handles, curved is where the shaft is curved so the tips are lower than the handles and long reach refers to the tips are angled downwards so they sit much lower in the incision.

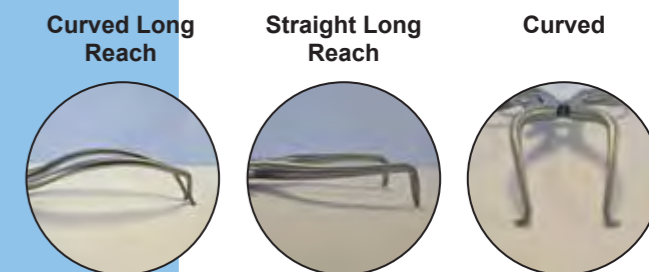

Order Code	Description
RT-GP-90-CV	Gelpi Mini 45mm Spread Curved 90mm Sharp Tip
RT-GP-135-CV	Gelpi 60mm Spread Curved 135mm
RT-GP-180-CV	Gelpi 120mm Spread Curved 180mm

Order Code	Description
RT-GP-135-SLR	Gelpi 60mm Spread Straight Long Reach 135mm Long Reach=20mm
RT-GP-180-CLR	Gelpi 120mm Spread Curved Long Reach 180mm LR=25mm
RT-GP-180-SLR	Gelpi 120mm Spread Straight Long Reach 180mm LR=25mm
RT-GP-180-CXLR	Gelpi Extra Long Reach Retractor 180mm LR=60mm
RT-GP-180-CXLR-S	Gelpi Extra Long Reach Retractor 180mm LR=60mm – Sharp Tip

LR = Long Reach.

Odd leg Gelpis are supplied in a pair with the opposing tips on each being long and short; this allows the surgeon to create a rectangular shaped site to work in.

Order Code	Description
RT-GP-OL-13	Gelpis Odd Leg (Pair) 130mm
RT-GP-OL-20	Gelpis Odd Leg (Pair) 200mm

This design of mini Gelpis is specifically useful for performing mini medial arthrotomies for TPLO and TTA surgeries. They maintain the incision edges under tension reducing haemorrhage and their small size does not obscure the surgeons view or get entangled in the other instruments being used in the same small area.

Order Code	Description
RT-GP-90-ST-SLR	Gelpi Mini 45mm Spread Straight 90mm Flat Tips

Apart from the 90mm Gelpis all the rest are blunt-tipped as standard, as this is less atraumatic. We can supply sharp-tipped Gelpis on request. Please allow longer for delivery on these items.

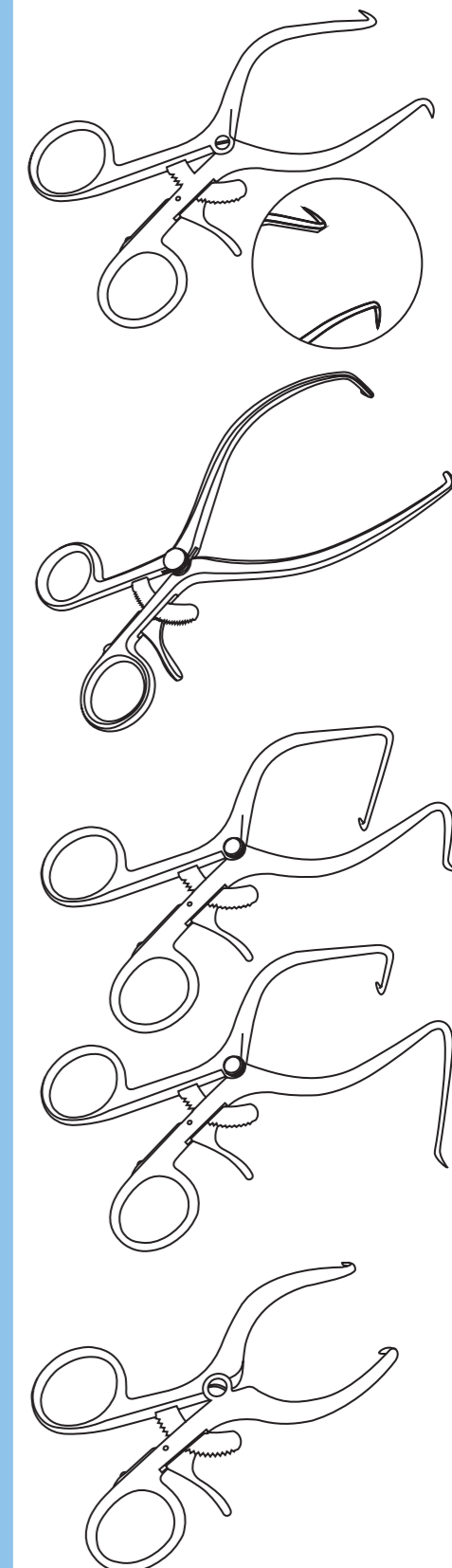

Retractor - Stifle

Similar to the Gelpi but the tips overlap to create a small spread size ideal for joints such as the knee. Supplied in either Ratchet or Spinlock options.

Order Code	Description
SD-17-RT	Stifle/Joint Distractor Ratchet 8mm Min Spread, Max Spread 30mm, 170mm
SD-19-RT	Stifle/Joint Distractor Ratchet 8mm Min Spread, Max Spread 30mm, 190mm

SD-14-SL	Stifle/Joint Distractor Spinlock 6mm Min Spread, Max Spread 30mm, 140mm
SD-17-SL	Stifle/Joint Distractor Spinlock 8mm Min Spread, Max Spread 30mm, 170mm
SD-19-SL	Stifle/Joint Distractor Spinlock 8mm Min Spread, Max Spread 30mm, 190mm
SD-21-SL	Stifle/Joint Distractor Spinlock 10mm Min Spread, Max Spread 40mm, 210mm

SD-10-RT-AH	Stifle/Joint Distractor Ratchet 3mm Min Spread, Max Spread 40mm, 100mm with teeth Gelpi Style Handle
SD-14-RT-AH	Stifle/Joint Distractor Ratchet 6mm Min Spread, Max Spread 60mm, 140mm with teeth Gelpi Style Handle
SD-14-SL-AH	Stifle/Joint Distractor Spinlock, 6mm Min Spread, Max Spread 60mm, 140mm Long with Gelpi Style Handle

Improves joint visibility particularly in osteoarthritic stifles.

SD-EX-ART-25	Extra Articular Stifle Distractor 2.5mm Pins - 80mm
SD-EX-ART-32	Extra Articular Stifle Distractor 3.2mm Pins - 80mm

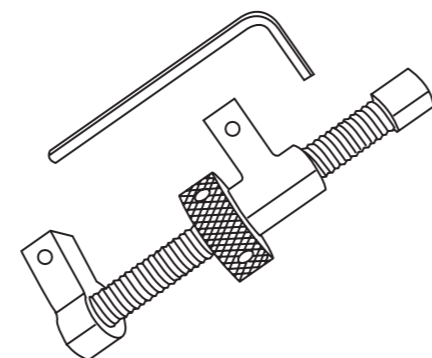
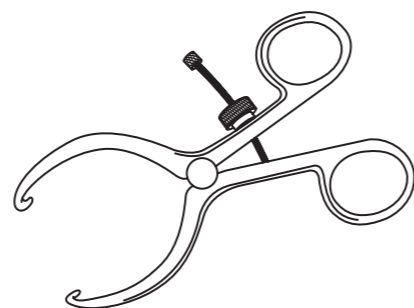
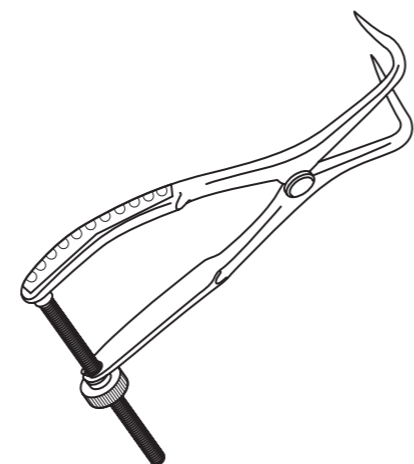
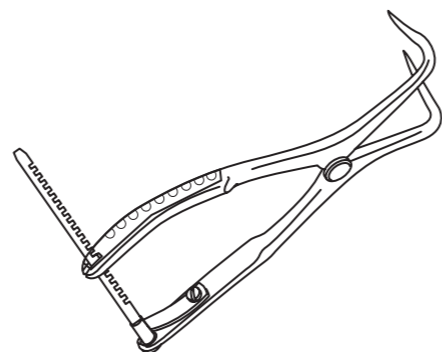

Stifle Lever

Designed for larger dogs to fit around the trochlea and helps expose the medial meniscus.

Order Code	Description
SL-22	Stifle Lever 220mm

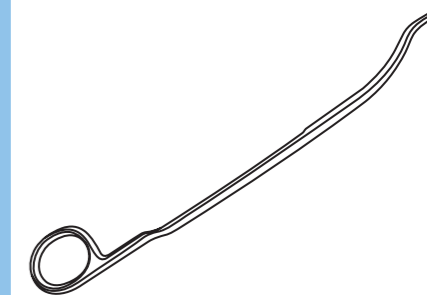

Fat Pad Retractor

Helps pull back the fat pad to improve sight of the medial meniscus.

Order Code	Description
RT-FP-18	Fat Pad Retractor 180mm
RT-FP-S	Small Fat Pad Retractor

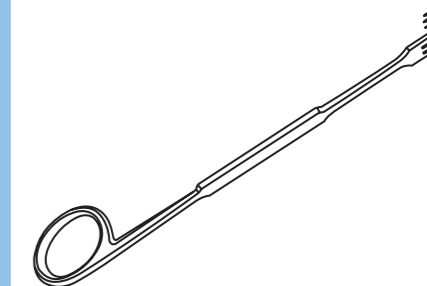

Toothed Halstead Forceps

The rat tooth tips are particularly useful for grasping ligaments or cartilage.

Order Code	Description
FC-HM-T-12-CV	Halstead Mosquito 120mm 1/2 Teeth Curved
FC-HM-T-12-ST	Halstead Mosquito 120mm 1/2 Teeth Straight

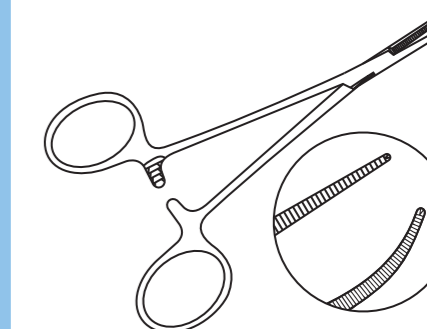

Meniscal Instruments

Instruments designed to tidy up Meniscal tears.

Order Code	Description
MN-HK-BLD	Meniscal Hook Blade
MN-PK-BLD	Meniscal Push Blade
MN-KN-16	Meniscal Knife 165mm

Designed to probe the Meniscus from above and below to identify tears and laxity. Also useful for manipulating nerves in spinal surgery.

Order Code	Description
MN-H-1-190	Meniscus Probe/Nerve Hook 1mm
MN-H-2-220	Meniscus Probe/Nerve Hook 2mm

Industry standard saw consisting of one stainless steel handle and 5 chrome plated blades that can be adjusted for various lengths of working area.

Order Code	Description
AD-SW-HANDLE	Spare Handle for the Adjustable Bone Saw
AD-SW-BLADES	Pack of 5 blades for Adjustable Bone Saw
AD-SW-SET	One Handle and 5 Blades Set

Hard edged saw for wedge trochleoplasty. These blades are very thin, with very fine teeth; this facilitates keying in the first pass on the slippery and thin trochlear ridges and inadvertently skidding off and damaging the articular cartilage in the sulcus.

Order Code	Description
HD-BACK-SW	Ortho Hardback Saw

Used to debur any rough edges of bone post excision arthroscopy.

Order Code	Description
RA-EA-17	Excision Arthroplasty Rasp

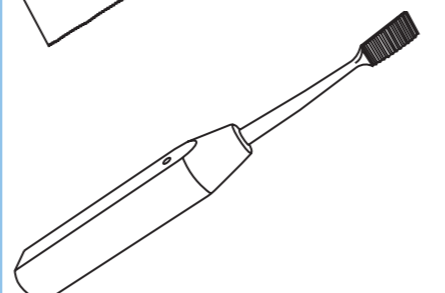
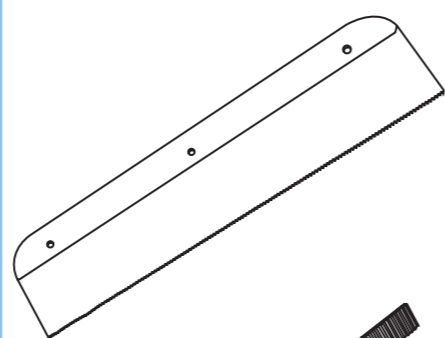
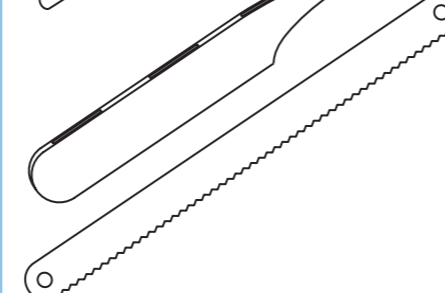
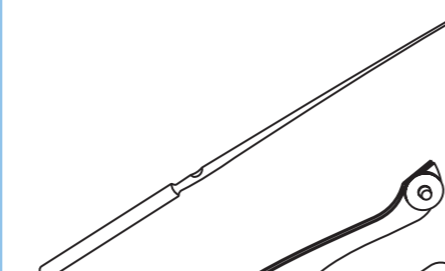
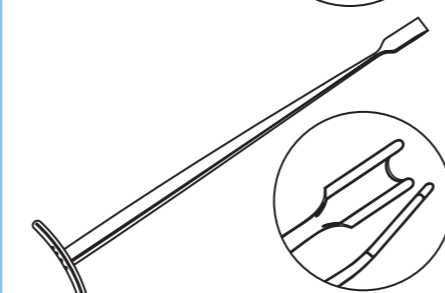
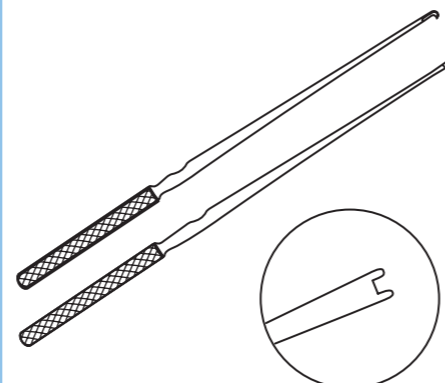

Meniscal Instruments cont.

Set of 3 rasps and a handle to remove/file bone after excision arthroplasty.

Order Code	Description
BR-ORTHO-3	Orthopaedic Bone Rasp - Set 3

Useful for cutting bone in hard to reach places. The blades are thin enough to fit through small holes to ensure precision cuts.

Order Code	Description
GG-SW-75	Gigli Saw Handles – Pair

Four different sized scalpel saw blades; these are extremely thin making them perfect for delicate procedures. Designed to fit a standard No.3 scalpel handle. For the scalpel handles see page 82.

Order Code	Description
SB-SET-4	Scalpel Saw Blade Set of 4

Post Sulcoplasty rasp, double ended.

Order Code	Description
BR-R-21	Rectangular Bone Rasp 210mm

Used to improve the trochlear groove.

Order Code	Description
RS-TROC	Trochlear Rasp 4.5mm min 10.5mm max

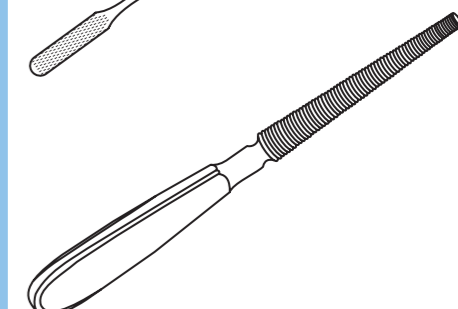
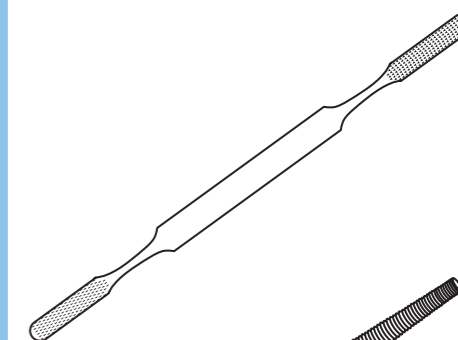
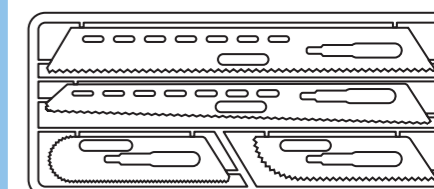
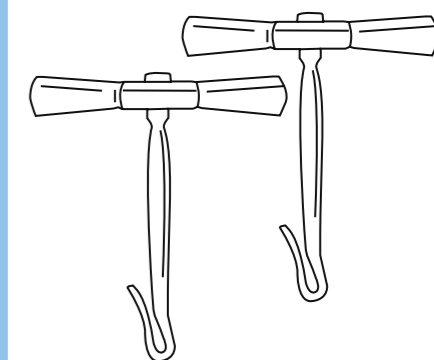
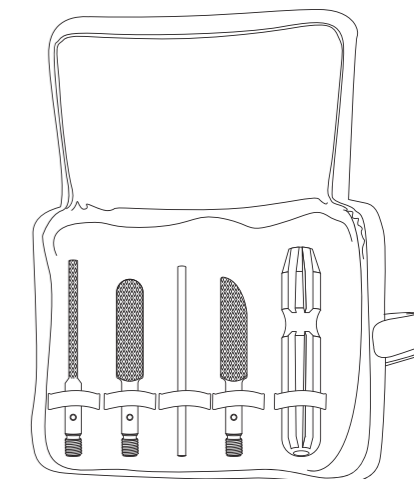

OCD Curette

Designed to remove loose cartilage around OCD lesion.

Order Code	Description
CU-OCD-18	OCD Curette 185mm
CU-OCD-21	OCD Curette 215mm

Retractor - Hohman

Designed for retracting tissues around bone for a clear site of the working area or manipulating bone into position.

Order Code	Description
RT-HOH-6-PB	Hohman Retractor 6mm Blade 160mm Length, Angled for Total Hip Replacement
RT-HOH-6	Hohman Retractor 6mm Blade 160mm Length
RT-HOH-8	Hohman Retractor 8mm Blade 220mm Length
RT-HOH-12	Hohman Retractor 12mm Blade 220mm Length
RT-HOH-15-S	Hohman Retractor 15mm Blade 160mm Length, Short
RT-HOH-18	Hohman Retractor 18mm Blade 240mm Length
RT-HOH-24	Hohman Retractor 24mm Blade 270mm Length
RT-HOH-36	Hohman Retractor 36mm Blade 240mm Length
RT-HOH-48	Hohman Retractor 48mm Blade 240mm Length
RT-HOH-18-SNT	Hohman Retractor 18mm Blade 240mm Length, Short Narrow Tip
RT-HOH-20-SN	Hohman Retractor 20mm Blade 200mm Length, Short Kinked Tip
RT-HOH-24-LBT	Hohman Retractor 24mm Blade 280mm Length, Long Broad Tip

Mallets

Stainless Steel Mallets.

140g Mallet is ideal weight for Trochlea Block Sulcoplasty.

300g Mallet is ideal for driving osteotome during femoral head and neck excision.

Order Code	Description
ML-14	140g Mallet
ML-30	300g Mallet

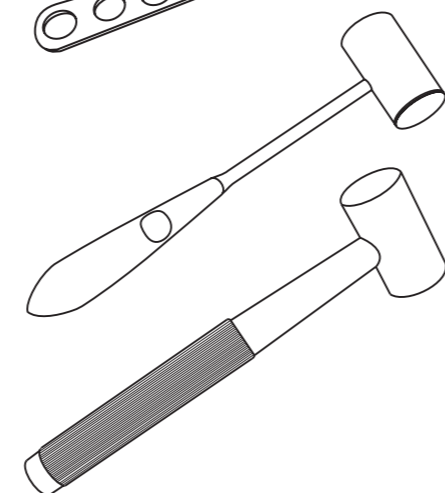
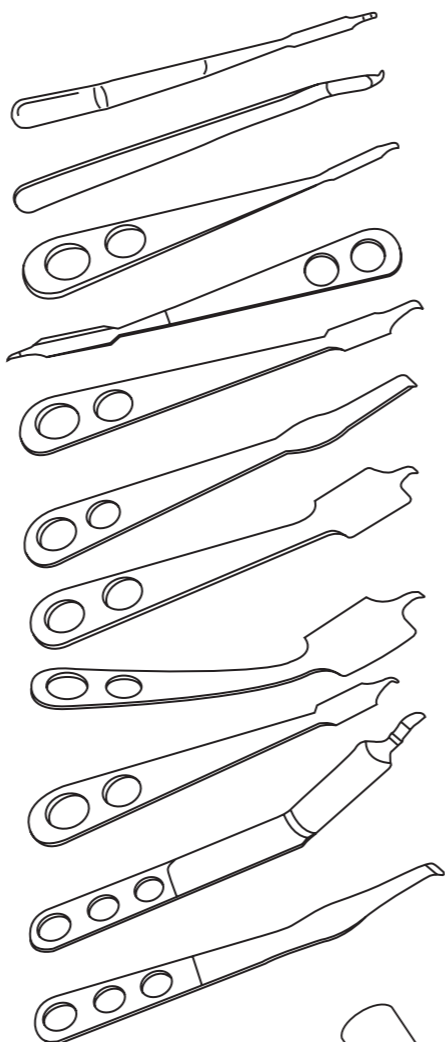
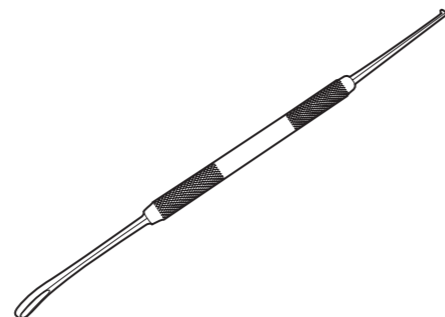

Gouge

Used for channelling or scooping bone.

Order Code	Description
GO-4-14	Gouge - 4mm - 140mm
GO-6-14	Gouge - 6mm - 140mm
GO-8-14	Gouge - 8mm - 140mm
GO-10-14	Gouge - 10mm - 140mm
GO-12-14	Gouge - 12mm - 140mm

Osteotomes

Small Length Osteotome for precisely cutting bone in a variety of procedures.

Order Code	Description
OS-2-14	Light Osteotome 2mm - 140mm
OS-4-14	Small Osteotome 4mm - 140mm
OS-6-14	Small Osteotome 6mm - 140mm
OS-8-14	Small Osteotome 8mm - 140mm
OS-10-14	Small Osteotome 10mm - 140mm
OS-12-14	Small Osteotome 12mm - 140mm
OS-15-14	Small Osteotome 15mm - 140mm

The whole instrument is narrow and the blade tip is sharp, making it very useful for block sulcoplasty.

Order Code	Description
OS-GD-2	Gordon Coronoid Osteotome 2mm

Larger alternative to the above Osteotomes, come with the Swedish type handle.

Order Code	Description
OS-10-20	Large Osteotome 10mm - 200mm
OS-12-20	Large Osteotome 12mm - 200mm
OS-15-20	Large Osteotome 15mm - 200mm
OS-20-20	Large Osteotome 20mm - 200mm
OS-25-20	Large Osteotome 25mm - 200mm

Small and narrow allowing tidying of edges of sulcoplasty without damaging it.

Order Code	Description
OS-SLIM-8	Super Slim Osteotome 8mm

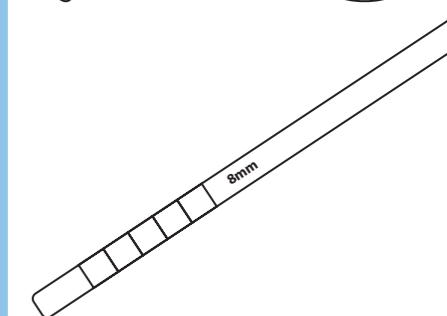
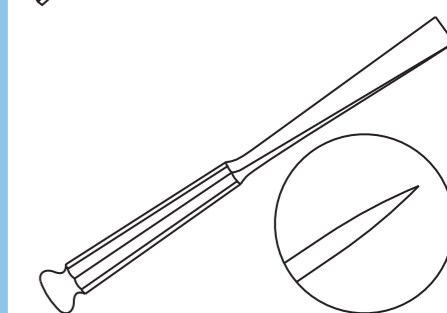
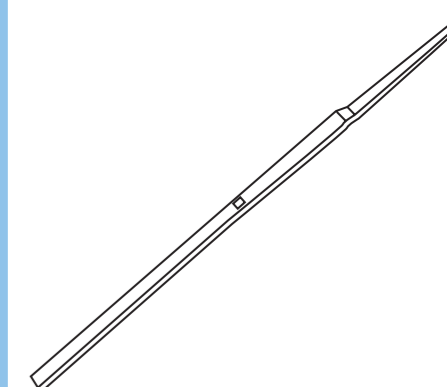
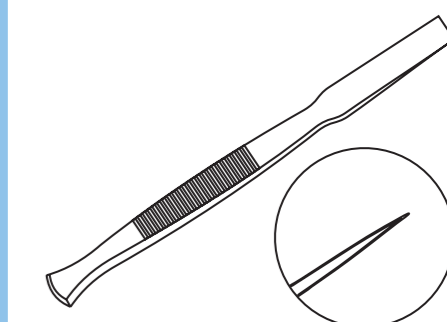
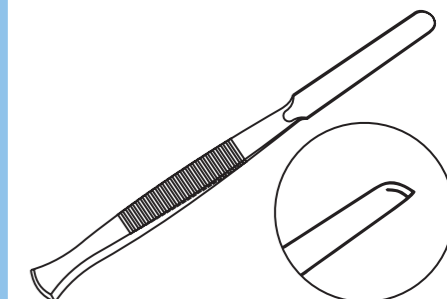

Total Hip Replacement Instruments



“The pointed deep reach Gelpis in combination with the fine bent Hohmann retractor allow fantastic exposure of the acetabulum during total hip replacement. This facilitates accurate reaming of the acetabulum with only a single assistant. Another set of great custom instruments from N2”

ROB QUINN

BVMS(Hons) CertAVP Dip. ECVS MRCVS
 RCVS & EBVS® European Specialist in
 Veterinary Surgeon Diplomate -
 Orthopaedics and Soft Tissue Surgery



- 🌐 www.n2-uk.com
- ☎ +44 (0)23 9323 3265
- ✉ @n2ukcom
- 📘 www.facebook.com/n2ukltd
- ✉ sales@n2-uk.com
- 📦 office@n2-uk.com for orders

Quinn Hip Instrument Set

Designed by Rob Quinn – BVMS(Hons) CertAVP DipECVS MRCVS, these modified instruments make hip procedures easier and improve the site visibility.

Order Code	Description
RT-GP-180-CXLR-S	Gelpi Extra Long Reach Retractor 180mm LR=60mm Sharp Tip
RT-HOH-6-PB	6mm Angled Hohman for Total Hip Replacement
THR-SET-BASIC	A set of both above items

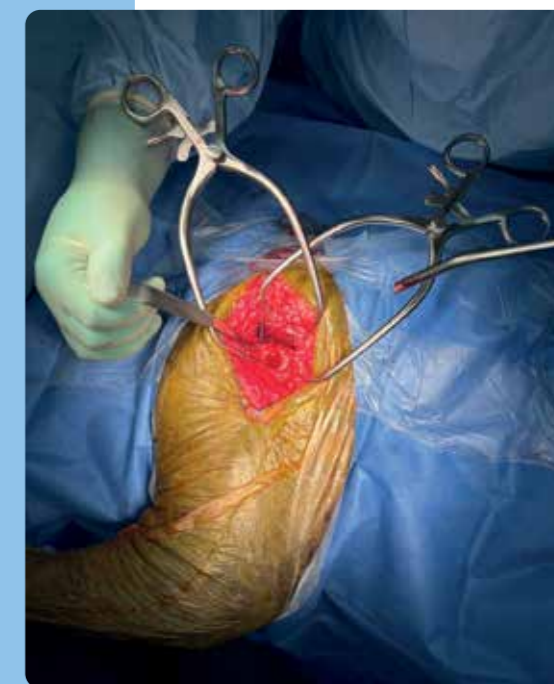

For full terms and conditions please visit our website.

Modular Osteotome

One teflon handle and set of 7 thin blades helps minimise bone damage. A must for any practice.

Order Code	Description
MD-OST-SET	Modular Osteotome Set with 7 Blades

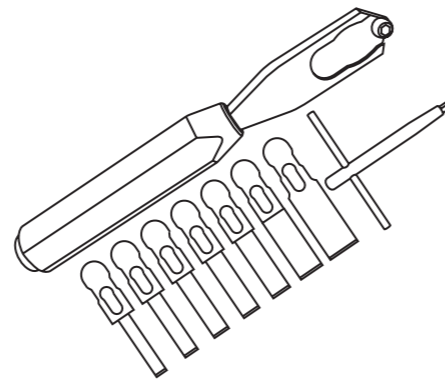

Disarticulators

Helpful instrument to loosen the femoral head from capsule and ligaments.

Order Code	Description
DI-SM	Disarticulator Small
DI-LG	Disarticulator Large

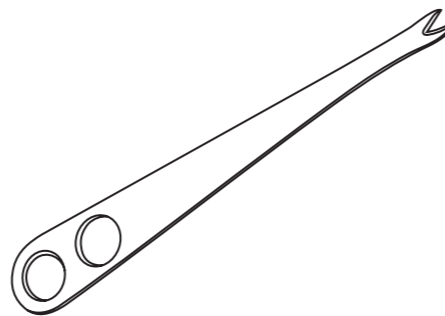

Hatt Spoons

Spoon design with a sharp edge makes it a useful alternative to a disarticulator in larger dogs.

Order code	Description
SP-HAT-0712	Hatt Spoon/Curette 7mm x 12mm Scoop
SP-HAT-1218	Hatt Spoon/Curette 12mm x 18mm Scoop
SP-HAT-1730	Hatt Spoon/Curette 17mm x 30mm Scoop

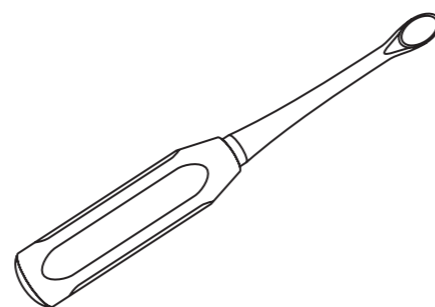

Screw/Drill Measuring Gauge

Handy tool for measuring screws and drill bits.

Order Code	Description
SC-DR-GAUGE	Screw/Drill Measuring Gauge

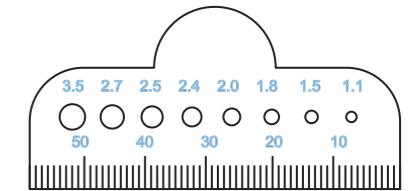

X-Ray Marker

Makes side identification easy and scaled for extra usefulness.

Order Code	Description
XRAY-SET	Stainless Steel Marker Set



X-Ray Marker Personalised

Minimum qty is 50 sets but we now have the capabilities to laser cut your logo into the markers, so it will show up on every x-ray they are used in, a great way to keep your brand in the veterinary public eye.

Order Code	Description
XRAY-MARK-SET-50	Personalised X-Ray Marker Sets with Customer Logo



Ruler

Also has holes to help with drill bit identification.

Order Code	Description
RUL-MET	Stainless Steel Metric Ruler



Quick Release Adaptor for Jacobs Chuck

Fits in standard Jacobs chucks to convert it to fit standard quick release drill bits and attachments.

Order Code	Description
JC-QR-ADAPT	Quick Release Adaptor for Jacobs Chuck

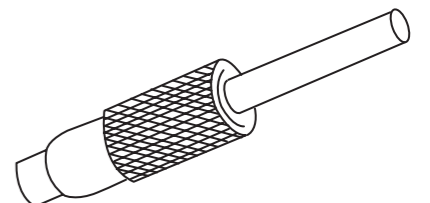

Premium Soft Tissue Kit

Consulting with experienced soft tissue surgeons we have created this premium soft tissue kit containing a selection of instruments they carry in their own kits. They are supplied in the premium non bagged, non-wrappable boxes and represent a large discount from buying individually.

Order Code	Description	Qty
CL-T-RA-16	Tonsillectomy Clamp Right Angled 160mm	1.0
FC-A-SW-18-CV	Spencer Wells Artery Forceps 180mm Curved	2.0
FC-DIS-AD-12-1/2S-TC	Adson Dissecting Forceps 120mm Serrated and Rat Tooth. T.C. Tip	1.0
FC-DIS-ADB-12	Adson-Brown Dissecting Forceps 120mm	2.0
FC-DIS-DB-18	Debaquey Dissecting Forceps 180mm	2.0
FC-HM-12-CV	Halstead Mosquito 120mm Curved	2.0
FC-HM-12-ST	Halstead Mosquito 120mm Straight	2.0
FC-HM-T-12-CV	Halstead Mosquito 120mm 1/2 Teeth Curved	1.0
JG285R	Tray with Lid 273 x 176 x 60mm	1.0
JG646B	ID Label...Colour: BLUE...Print Text (Max 13 Letters)	1.0
JK091	Reusable Container Filter (1 Pack of 2)	1.0
JN095	Sterile Box 313 x 190 x 92mm Outside Diameter	1.0
MAT-KIT-PRM-BKT	Silicone Insert for Premium Basket 265mm x 165mm	1.0
NH-OH-14-TC	Olsen Hegar Needle Holders T.C. 140mm	1.0
RT-GP-180-SLR	Gelpi 120mm Spread Straight Long Reach 180mm LR=25mm Blunt Tip	1.0
RT-GP-90-ST-SLR	Gelpi Mini 45mm Spread, 90mm Long & Straight Long Reach Arms	1.0
SC-MCB-18-CV-SC	Mayo Chamfered Blade Supercut 180mm Curved	1.0
SC-MCB-18-ST-SC	Mayo Chamfered Blade Supercut 180mm Straight	1.0
SC-MZ-16-CV-SCTC	Metzenbaum Scissors Supercut T.C. 160mm Curved	1.0
SC-SS-C-12	Castroviejo Suture Scissors 120mm	1.0
SH-03	Scalpel Handle no3 with Scale 125mm	2.0
TC-BT-9	Backhaus Towel Clip 90mm	8.0
TF-AL-15-2/3	Allis Tissue Forceps 2/3 Teeth 150mm	2.0
TF-BAB-180	Babcock Tissue Forceps 180mm	1.0



Hex Head Screwdrivers

Standard Screwdrivers for Hex Head Screws.

Order Code	Description
SD-H15	Screwdriver for 1.5mm, 2.0mm and 2.4mm Hex Screws with Sleeve
SD-H20	Screwdriver for 2.4mm Screws with 2.0mm Hex Holes with Sleeve
SD-H25	Screwdriver for 2.7mm, 3.5mm and 4.0mm Hex Screws with Sleeve
SD-H35	Screwdriver for 4.5mm, 5.5mm and 6.5mm Hex Screws with Sleeve
SD-H25-LH	Wooden Effect Handle Screwdriver 2.5mm Hex for 2.4/2.7/3.5mm Screws

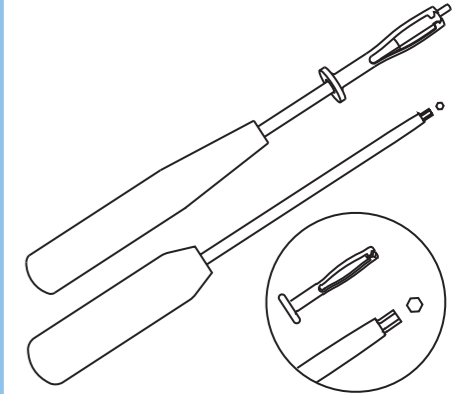

Torx/Star Head Screwdrivers

Hardened Tipped Screwdrivers for Torx Screws.

Order Code	Description
SD-TD-T6	Screwdriver for 2.0mm Star Torx Drive Locking Screws
SD-TD-T8	Screwdriver for 2.4mm/2.7mm Star Torx Drive Locking Screws
SD-TD-T15	Screwdriver for 3.5mm Star Torx Drive Locking Screws

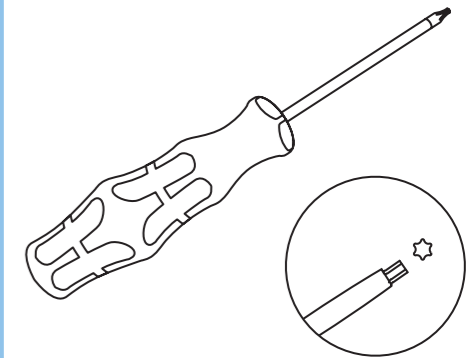

Quick Release Screwdriver Tips

Superior Quality Hardened Screwdriver Tips.

Order Code	Fits Screw sizes
SDT-QR-H15	Hex Screwdriver Tip for 1.5, 2.0, 2.4mm Screws
SDT-QR-H20	Hex Screwdriver Tip for 2.4mm Cortical Screws with 2.0mm Hex
SDT-QR-H25	Hex Screwdriver Tip for 2.7, 3.5, 4.0mm Screws
SDT-QR-H35	Hex Screwdriver Tip for 4.5, 6.5mm Screws
SDT-QR-C24	Cruciform Screwdriver Tip for 2.4mm Screws

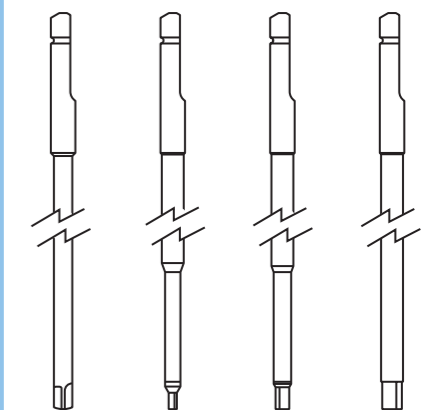

For screws see page 9 of the implant catalogue.

Premium Screwdriver Tips

Superior Quality Hardened Screwdriver Tips for Star Torx Head Screws.

Order Code	Description
SDT-QR-T6	T6 Premium Screwdriver Tip for 2.0mm Torx Head Screws
SDT-QR-T8	T8 Premium Screwdriver Tip for 2.4/2.7mm Torx Head Screws
SDT-QR-T15	T15 Premium Screwdriver Tip for 3.5mm Torx Head Screws

Screw Holding Sleeves

Order Code	Description
SD-SLEEVE-152024	Spare Screw Holding Sleeve for 1.5mm Hex Screwdriver (SD-H15)
SD-SLEEVE-273540	Spare Screw Holding Sleeve for 2.5mm Hex Screwdriver (SD-H25)
SD-SLEEVE-4565	Spare Screw Holding Sleeve for 3.5mm Hex Screwdriver (SD-H35)
SHS-T6	Screw Holding Sleeve for T6 Screwdriver and Premium Tips
SHS-T8	Screw Holding Sleeve for T8 Screwdriver and Premium Tips
SHS-T15	Screw Holding Sleeve for T15 Screwdriver and Premium Tips

Screwdriver to fit all Suture Head Screws, for kit see page 115.

Order Code	Description
SA-INSERT	Universal Suture Screw Insertion Driver

2.4mm Cross Head Screwdriver for TCS-24 screws.

Order Code	Description
SD-C24	Screwdriver 2.4mm Cross-Head (2.4mm Titanium Screws)

For screws see page 9 of the implant catalogue.

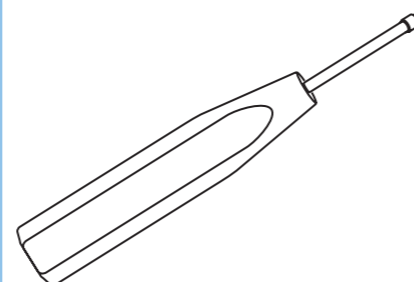
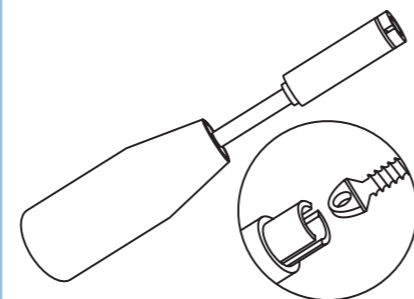
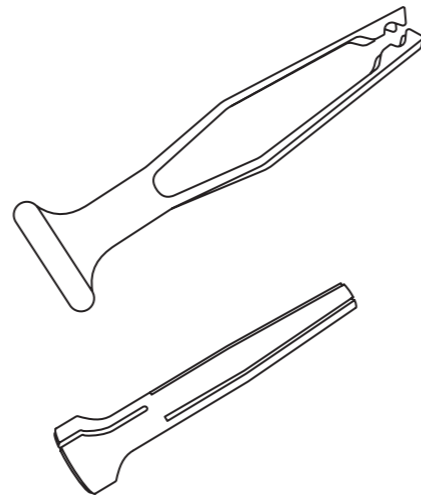

Sherman Screwdrivers

Order Code	Description
SD-F20-L17	Screwdriver Flat Head 2.0mm Length 175mm
SD-F27-L17	Screwdriver Flat Head 2.7mm Length 175mm
SD-F35-L17	Screwdriver Flat Head 3.5mm Length 175mm
SD-C35-L25	Screwdriver Cross Head 3.5mm Length 250mm

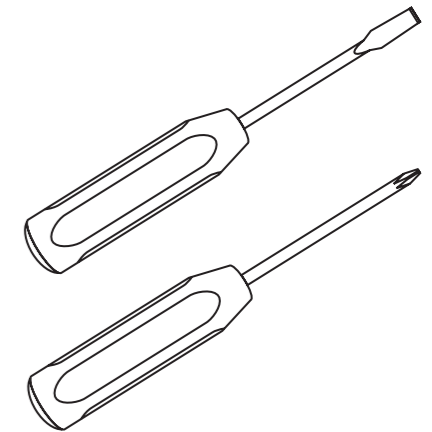

Screw Driver Handles - Premium AO & Dental Fit Quick Release

A range of premium screwdrivers with a silicone handle, available in standard quick fit, T-bar and dental fit. The silicone handle greatly improves the anti-slip surface in a gloved hand, whilst also being easier to clean.

Order Code	Description
SGH-DF	Premium Quality Comfort Silicone Handle - Dental Fit
SGH-QF	Premium Quality Comfort Silicone Handle - AO Quick Release
STH-QF	Premium Quality Comfort Silicone Handle - T-Bar AO Quick Release

Colour may vary.



There is also a standard version with Teflon handle.

Order Code	Description
SD-TFN-QR	Standard Teflon Quick Release Screwdriver Handle

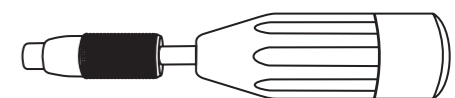

For screws see page 9 of the implant catalogue.

Tissue Protection Sleeves

Protects tissues around the area you are drilling/tapping e.g. bone tunnels for toggling and drilling in deep spaces such as acetabularly and through the femoral neck during placement of hip toggles.

Order Code	Description
TP-S-20	Tissue Protection Sleeve for 2.0mm Taps/Drills
TP-S-24	Tissue Protection Sleeve for 2.4mm Taps/Drills
TP-S-27	Tissue Protection Sleeve for 2.7mm Taps/Drills
TP-S-35	Tissue Protection Sleeve for 3.5mm Taps/Drills
TP-S-45	Tissue Protection Sleeve for 4.5mm Taps/Drills

Mini Screwdriver

Uses thumb and forefinger control rather than your wrist for more precise control on the smaller screws.

Order Code	Description
SD-150-H	Knurled One Piece Stainless Steel Driver with 1.5mm Hex

Adjustable Drill Guide Set

Adjustable Drill Guide allows accurate placement of drill holes by predetermination of entry and exit points. Pointed tips bite into the bone to ensure stability.

Order Code	Description
DG-ADJ-2035	Adjustable Drill Guide for 2.0, 2.5, 3.5 Drills

Drill Guides Load/Neutral

This guide has both compression and neutral holes to allow flexibility in screw placement. The tips have a special end that fits into appropriate compression plates. Compression end is marked with an arrow. For compression plates see page 58 of the implant catalogue.

Order Code	Description
LN-DG-15	Load/Neutral Drill Guide for 1.5mm Compression Plates
LN-DG-20	Load/Neutral Drill Guide for 2.0mm Compression Plates
LN-DG-24	Load/Neutral Drill Guide for 2.4mm Compression Plates
LN-DG-27	Load/Neutral Drill Guide for 2.7mm Compression Plates
LN-DG-35	Load/Neutral Drill Guide for 3.5mm Compression Plates
LN-DG-45	Load/Neutral Drill Guide for 4.5mm Compression Plates
LN-DG-55	Load/Neutral Drill Guide for 5.5mm Compression Plates

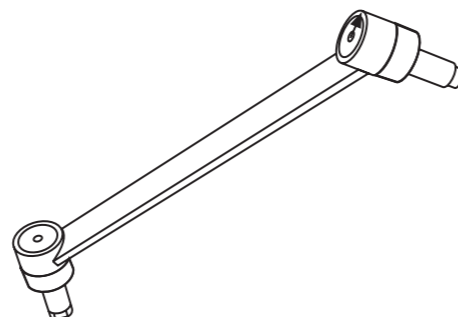
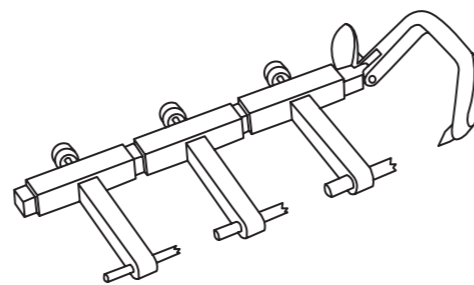
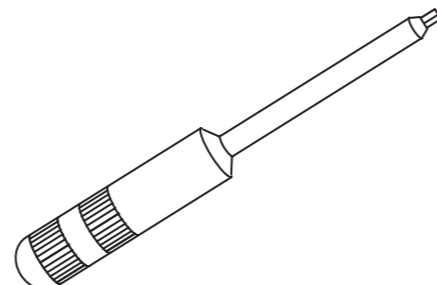
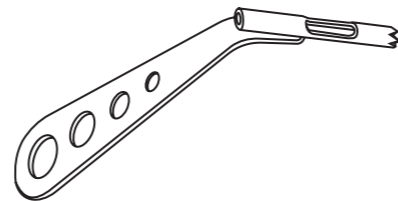

Insert Sleeves

Internal diameter is set at the predrill size for the same screw size as the external measurement making it useful for lag screwing.

Order Code	Description
IS-20-15	Insert Sleeve 2.0mm o/d 1.5mm i/d
IS-24-18	Insert Sleeve 2.4mm o/d 1.8mm i/d
IS-27-20	Insert Sleeve 2.7mm o/d 2.0mm i/d
IS-30-20	Insert Sleeve 3.0mm o/d 2.0mm i/d
IS-35-20	Insert Sleeve 3.5mm o/d 2.0mm i/d
IS-35-25	Insert Sleeve 3.5mm o/d 2.5mm i/d
IS-35-27	Insert Sleeve 3.5mm o/d 2.7mm i/d
IS-45-32	Insert Sleeve 4.5mm o/d 3.2mm i/d
IS-45-32-L	Insert Sleeve 4.5mm o/d 3.2mm i/d
IS-55-40	Insert Sleeve 5.5mm o/d 4.0mm i/d
IS-65-45	Insert Sleeve 6.5mm o/d 4.5mm i/d

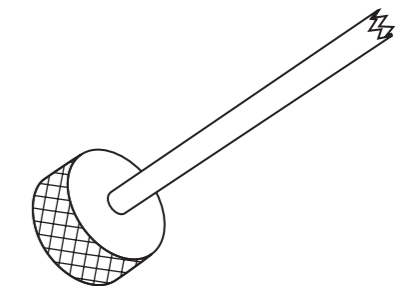

Combination Drill, Tap, Insert Sleeve

Large end is used as clearance drill and tap, the small end is used as a pilot drill and fits inside the hole drilled in the larger hole making it the ideal instrument for lag screw placement.

Order Code	Description
CD-TS-20	2.0mm Combination Drill, Tap and Insert Sleeve
CD-TS-24	2.4mm Combination Drill, Tap and Insert Sleeve
CD-TS-27	2.7mm Combination Drill, Tap and Insert Sleeve
CD-TS-35	3.5mm Combination Drill, Tap and Insert Sleeve
CD-TS-45	4.5mm Combination Drill, Tap and Insert Sleeve

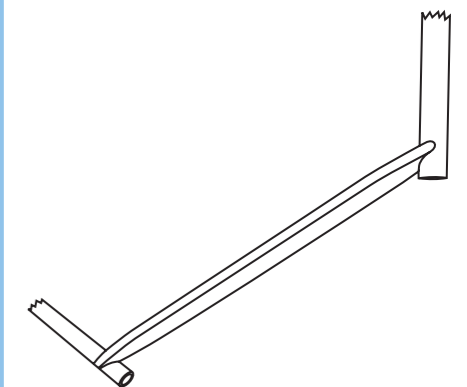

Self Centring Drill Guides

Useful in internal orthopaedics and external fixation these ensure the drill bits are placed centrally to the bone

Order Code	Description
DG-SC-11	Self Centring Drill Guide for 1.1mm Drill, 10mm Spread
DG-SC-15	Self Centring Drill Guide for 1.5mm Drill, 12mm Spread
DG-SC-20	Self Centring Drill Guide for 2.0mm Drill, 14mm Spread
DG-SC-25	Self Centring Drill Guide for 2.5mm Drill, 18mm Spread
DG-SC-32	Self Centring Drill Guide for 3.2mm Drill, 23mm Spread

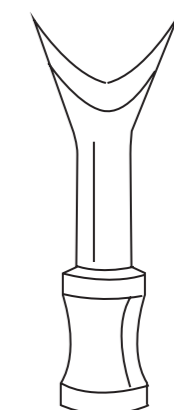

Depth Gauge

Used to measure the depth of the hole, the gauge has a small prong on the tip that sits on the trans/far cortex.

Order Code	Description
DE-GA-202427	Depth Gauge for 2.0mm/2.4mm/2.7mm Screws
DE-GA-2735	Depth Gauge for 2.7/3.5mm Screws
DE-GA-2735-L	Depth Gauge for 2.7/3.5mm Screws Long
DE-GA-4565	Depth Gauge for 4.5/6.5mm Screws

Order Code	Description
DE-GA-1520-PREM	Premium Depth Gauge for 1.5/2.0mm Screws
DE-GA-2735-PREM	Premium Depth Gauge for 2.7/3.5mm Screws

Countersinks

T Handle for more precise use, allows screw head to sit more flush to bone when not plating such as when using a lag screw.

Order Code	Description
CS-24-T	T Handle Countersink for 2.4mm Screws
CS-35-T	T Handle Countersink for 3.5mm Screws
CS-QR-HIF	AO Quick Release Chamfer Tool for N2 Style 4.5mm IOHC Screws with a 3.2 Pilot Hole
CS-QR-6	AO Quick Release Chamfer Tool 6mm x 45deg. Suits Pilot Holes from 1.1mm to 4.0mm

Bone Plate Clips

Safety pin clip to hold a range of one size of plate; the clips are labelled with the appropriate plate size.

Order Code	Description
BP-CLIP-15	Bone Plate Clip for 1.5mm Plates
BP-CLIP-20	Bone Plate Clip for 2.0mm Plates
BP-CLIP-24	Bone Plate Clip for 2.4mm Plates
BP-CLIP-27	Bone Plate Clip for 2.7mm Plates
BP-CLIP-35	Bone Plate Clip for 3.5mm Plates
BP-CLIP-45	Bone Plate Clip for 4.5mm Plates

Plate Benders Standard

Come as a pair and plates fit in the slots; twisting the handles gives the appropriate bending angles.

Order Code	Description
PB-L-1520	1.5mm/2.0mm Plate Bending Levers
PB-L-24	2.4mm Plate Bending Levers
PB-L-2735	2.7mm/3.5mm Plate Bending Levers
PB-L-3545	3.5/4.5mm Plate Bending Levers also used for Evolox® PCL Plates

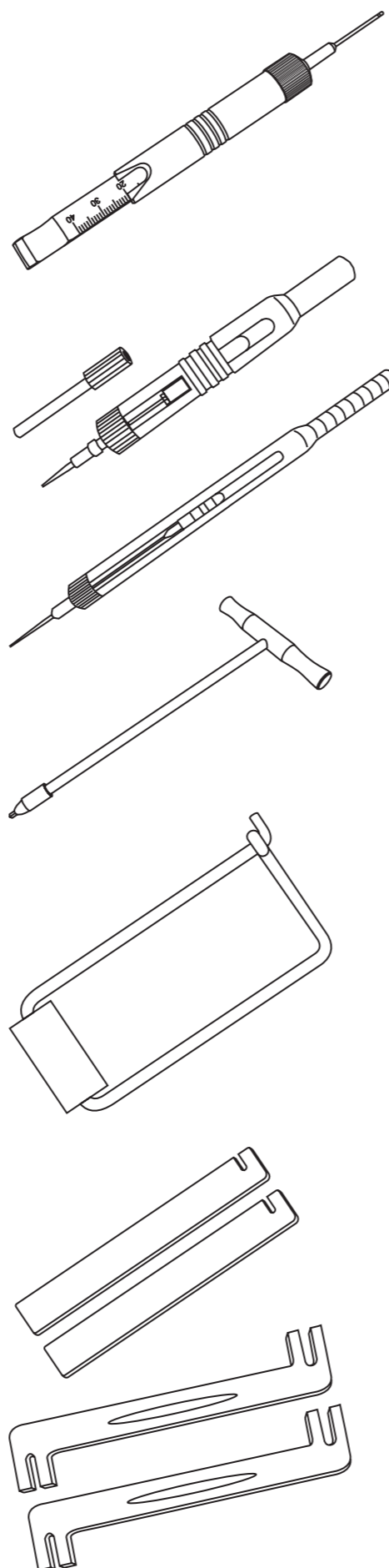

Plate Bending Pliers

More heavy duty than levers and designed for 2.7 and 3.5mm plates.

Order Code	Description
PB-P-2735	Plate Bending Pliers 2.7mm/3.5mm

Plate Benders Roller Type

Ideal for long curves in the plates.

Order Code	Description
PB-RT-3545	Plate Bending Pliers Roller Type 3.5mm - 4.5mm

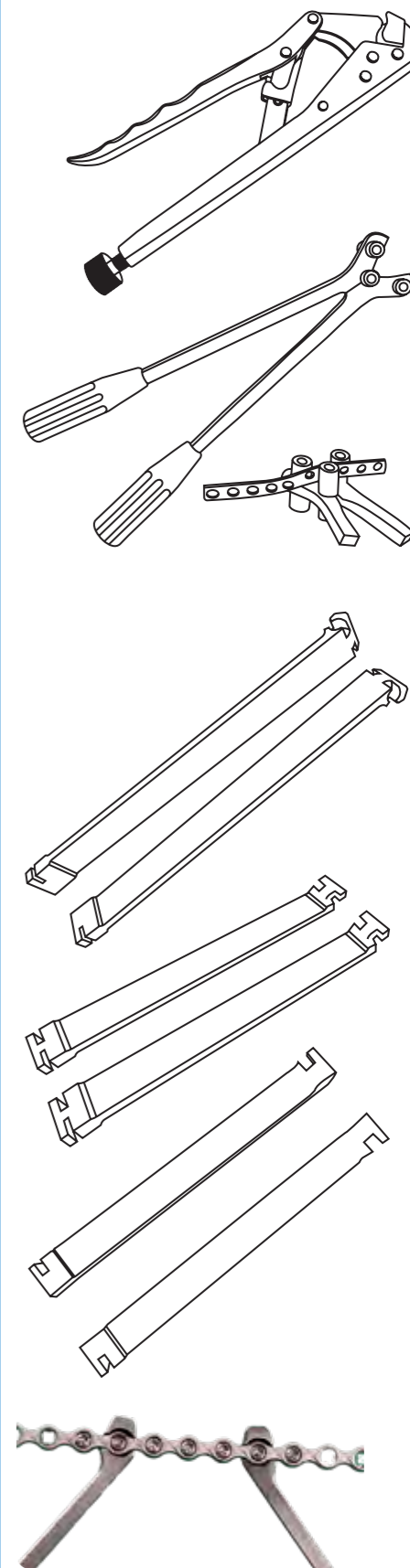

Plate Benders Evolox®

Double-ended benders with a slot for both the ball of the EV-OS plates and one for the shaft allowing bending in every plane. For osteosynthesis plates see page 138 of the implant catalogue.

Order Code	Description
EV-PB-2427	Evolox® Plate Bender 2.4/2.7mm
EV-PB-2735	Evolox® Plate Bender 2.7/3.5mm
EV-PB-35B	Evolox® Plate Bender 3.5mm Broad

Plate Press

The easiest way to put big angles into plates is with the press by lots of smaller contours along its length. The plate is bent against the adjustable anvil for a spread force effect.

Order Code	Description
BP-PRESS-30	Bone Plate Press to 3.5mm Narrow
BP-PRESS-41	Bone Plate Press All Plates

Forceps - Bone Holding

Various designs of bone holders with ratchet, spinlock and self centering grips. Spinlock generally offer the best controlled feel.

Order Code	Description
FC-SC-15	Bone Holding Forceps Self Centering 150mm
FC-SC-19	Bone Holding Forceps Self Centering 190mm
FC-SC-24	Bone Holding Forceps Self Centering 240mm

Allows bone to be held firmly in place whilst maintaining access to central area through gap between jaws.

Order Code	Description
FC-BH-15	Bone Holding Forceps Open Jaws 155mm
FC-BH-19	Bone Holding Forceps Open Jaws 195mm

Order Code	Description
FC-BH-18-SL	Bone Holding Forceps Open Jaws 180mm Spinlock

Designed for use in small dogs and cats. The contoured tips increase bone grip.

Order Code	Description
FC-SBH-XS	Extra Small Serrated Bone Holding Forceps 140mm
FC-SBH-S	Small Serrated Bone Holding Forceps 140mm
FC-SBH-L	Large Serrated Bone Holding Forceps 180mm

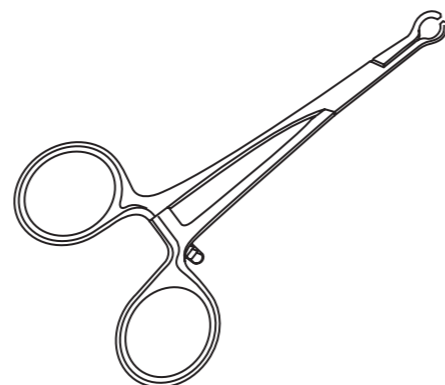
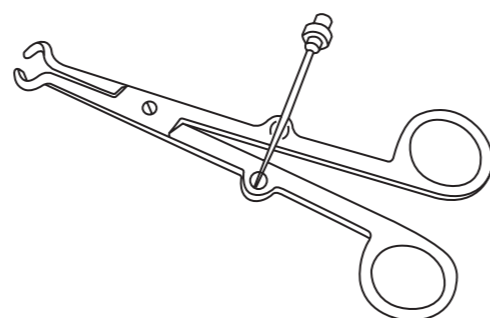
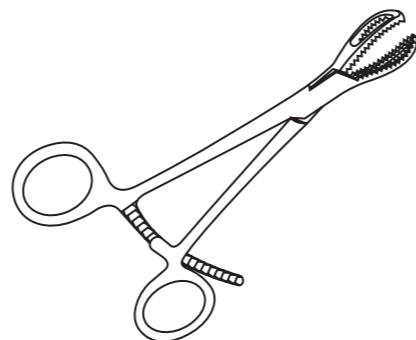
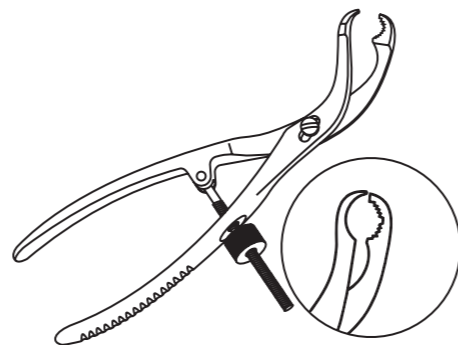
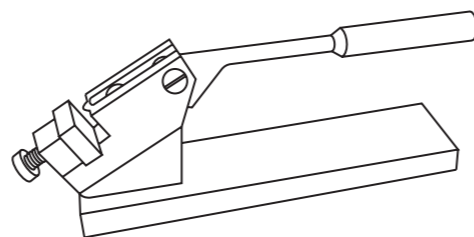

Forceps - Fragment

Bone holding forceps with jaws designed to engage a greater surface area of bone; greater traction can be safely applied.

Order Code	Description
FC-FR-10	Small Fragment Forceps 100mm
FC-FR-13	Medium Fragment Forceps 130mm
FC-FR-16	Large Fragment Forceps 160mm
FC-FR-20	Extra-Large Fragment Forceps 200mm

Order Code	Description
FC-FR-14-SL	Fragment Forceps 140mm Spinlock
FC-FR-18-SL	Fragment Forceps 180mm Spinlock
FC-FR-21-SL	Extra-Large Fragment Forceps 215mm Spinlock

Designed to grab the bone in two places off centre keeping the middle free for drilling.

Order Code	Description
FC-FR-TP-18	Twin Point Fragment Forceps 180mm
FC-FR-TP-21	Twin Point Fragment Forceps 215mm Spinlock

Forceps - Kern

Special bone holding forceps with jaws designed to fit round the bone and hold in place.

Order Code	Description
FC-K-BH-12	Kern Forceps - 120mm Ratchet
FC-K-BH-17	Kern Forceps - 170mm Ratchet
FC-K-BH-21	Kern Forceps - 210mm Ratchet

Spinlock version of above.

Order Code	Description
FC-K-BH-12-SL	Kern Forceps - 120mm Spinlock
FC-K-BH-17-SL	Kern Forceps - 170mm Spinlock
FC-K-BH-21-SL	Kern Forceps - 210mm Spinlock

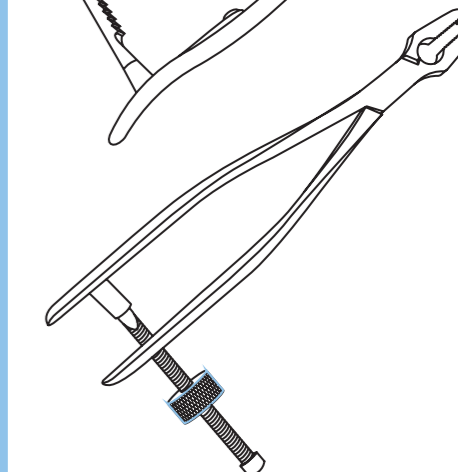
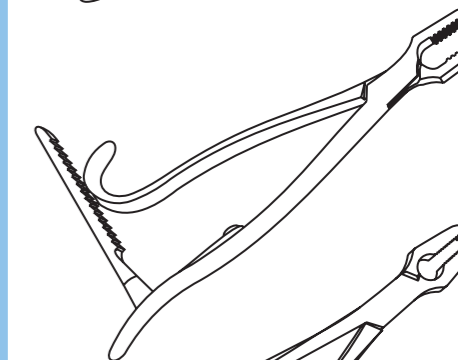
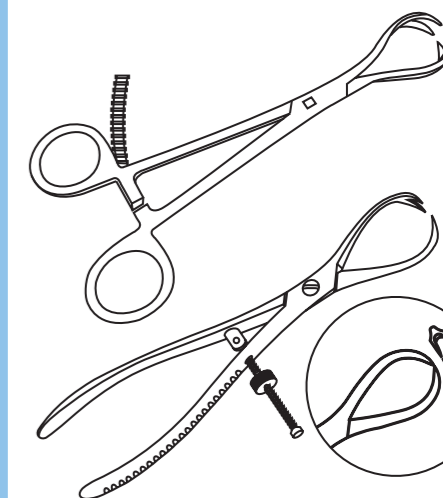
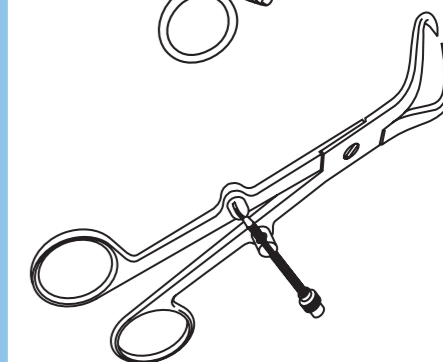
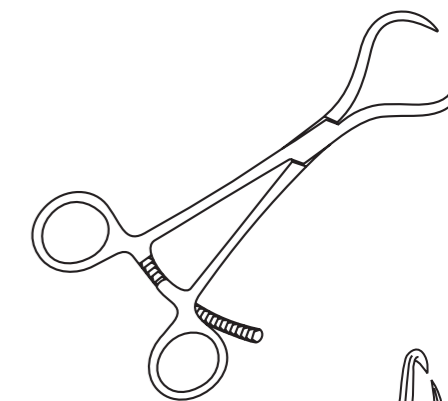

Plate Holding - Forceps

Two instruments in one, acts as holding forceps but also the tip fits inside the plate hole thus creating a drill guide and soft tissue protector.

Order Code	Description
FC-PH-DG-1520	1.5/2.0mm Plate Holding Forceps with Drill Guide
FC-PH-DG-2427	2.4/2.7mm Plate Holding Forceps with Drill Guide
FC-PH-DG-35	3.5mm Plate Holding Forceps with Drill Guide

Order Code	Description
FC-PH-DG-1520-SL	1.5/2.0mm Plate Holding Forceps with Drill Guide - Spinlock
FC-PH-DG-2427-SL	2.4/2.7mm Plate Holding Forceps with Drill Guide - Spinlock
FC-PH-DG-35-SL	3.5mm Plate Holding Forceps with Drill Guide - Spinlock

Useful forceps for holding plates to the bone until screwed into place. Alternatively useful for soft or brittle bone work with the ball acting as a stopper.

Order Code	Description
FC-PH-16	Plate Holding Forceps 160mm

Plate/Screw Forceps

For picking implants out of kits, forcep type instruments. These allow easy selection of implants and minimise blood contamination of your tray.

Order Code	Description
FC-SH-2055	Screw Holding Forceps 2.0mm-5.5mm Screws
FC-PH-1555	Plate Holding Forceps 1.5mm-5.5mm Plates

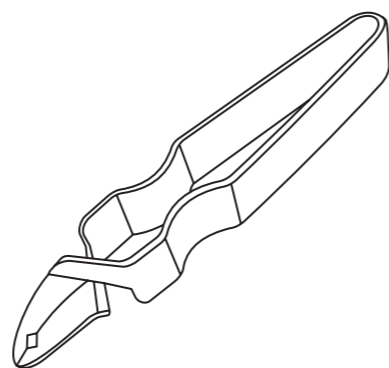
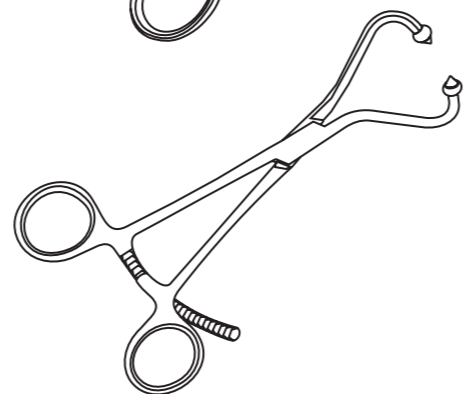
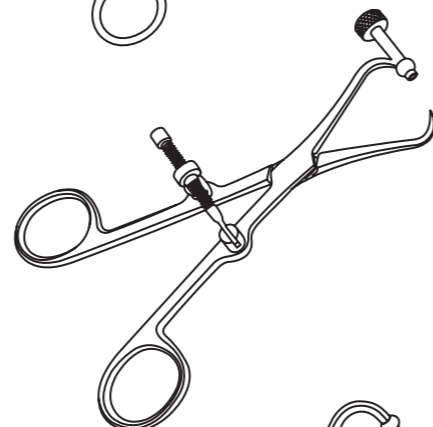
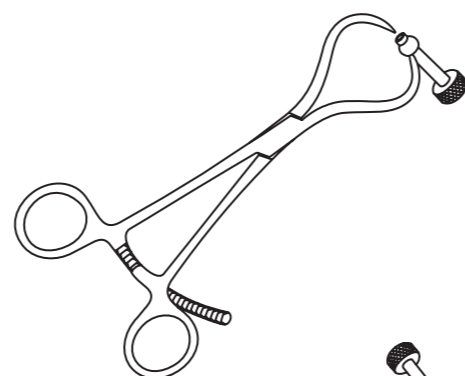

Reduction Forceps

Very similar to fragment forceps in design, available with a specially designed spinlock to help with bone reduction.

Order Code	Description
FC-RED-13-SJ	Reduction Forceps Straight Serrated 130mm
FC-RED-14	Reduction Forceps Curved Serrated 140mm
FC-RED-15	Reduction Forceps 150mm
FC-RED-20	Reduction Forceps 200mm

Order Code	Description
FC-RED-SL-17	Reduction Forceps Serrated Spinlock 170mm
FC-RED-SL-19	Reduction Forceps Serrated Spinlock 190mm
FC-RED-SL-24	Reduction Forceps Serrated Spinlock 240mm

Order Code	Description
FC-RED-14-P-CV	Reduction Forceps Serrated 140mm with Pointed Tip – Curved
FC-RED-14-P-CV-CT	Reduction Forceps Serrated 140mm with Pointed Tip – Curved – Closed Tips

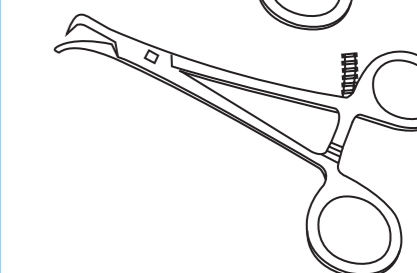
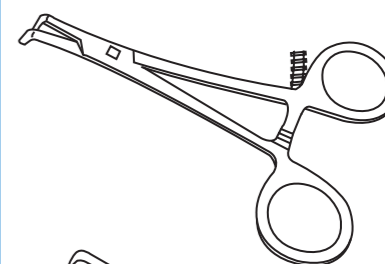
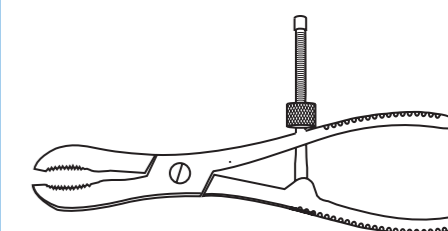
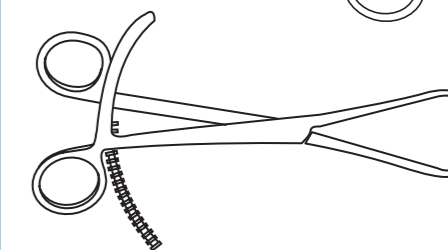
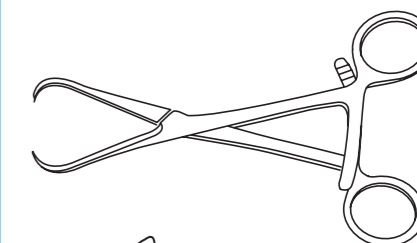
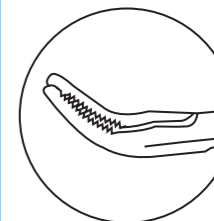
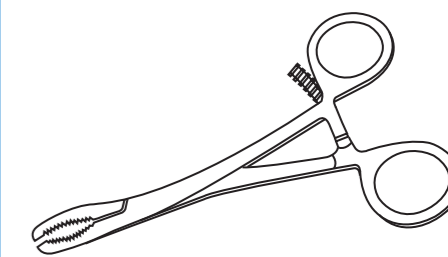

Ikuta Clamp

Ratchet instrument with prongs set apart to allow wires and screws to pass between them. These bone forceps are extremely useful in minimising the overriding of fragments or their slippage of patients less than 5kg; the curved handle often allows better visualisation of the fracture site.

Order Code	Description
CL-IK-2-CV	Ikuta Clamp Curved – 2mm Jaw Gap
CL-IK-2-ST	Ikuta Clamp Straight – 2mm Jaw Gap
CL-IK-3-CV	Ikuta Clamp Curved – 3mm Jaw Gap
CL-IK-3-ST	Ikuta Clamp Straight – 3mm Jaw Gap

Bone Cutter - Liston

Most commonly used type of bone cutter in the veterinary industry.

Order Code	Description
CT-LB-14-CV	Liston Bone Cutter 140mm Curved
CT-LB-14-ST	Liston Bone Cutter 140mm Straight
CT-LB-17-CV	Liston Bone Cutter 170mm Curved
CT-LB-17-ST	Liston Bone Cutter 170mm Straight
CT-LB-19-CV	Liston Bone Cutter 190mm Curved
CT-LB-19-ST	Liston Bone Cutter 190mm Straight

Order Code	Description
CT-SA-17	Small Angled Bone Cutter 170mm

Implant Cutters

Ideally designed for cutting close to the bone with close cut finish.

Order Code	Description
IC-CC-15-15	Implant Cutter Close Cut max cut 1.5mm 150mm Long with T.C. Jaws
IC-CC-2-16	Implant Cutter Close Cut max cut 2.0mm 160mm Long with T.C. Jaws

Light use standard blade cutter. Implant Cutters

Order Code	Description
IC-15-17	Implant Cutter max cut 1.5mm 170mm Long with T.C. Jaws
IC-22-23	Implant Cutter max cut 2.2mm 230mm Long

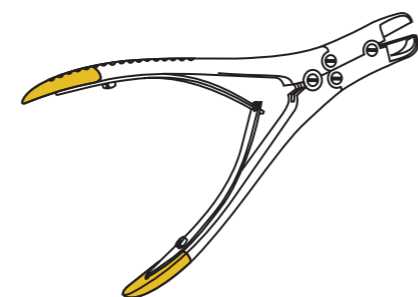
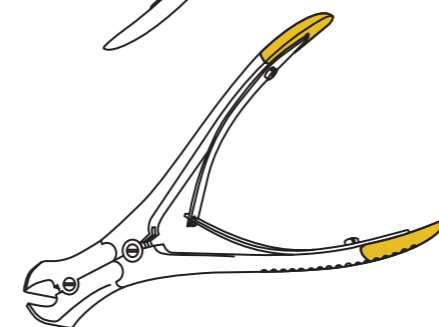
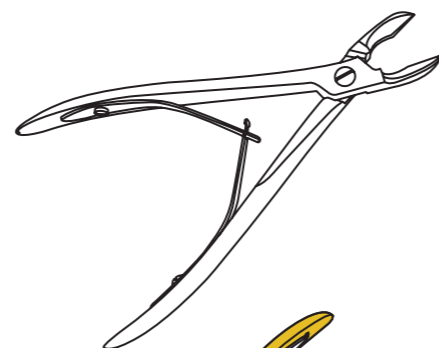
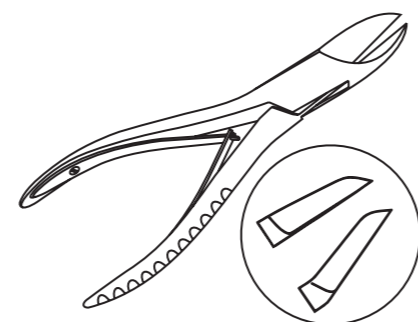
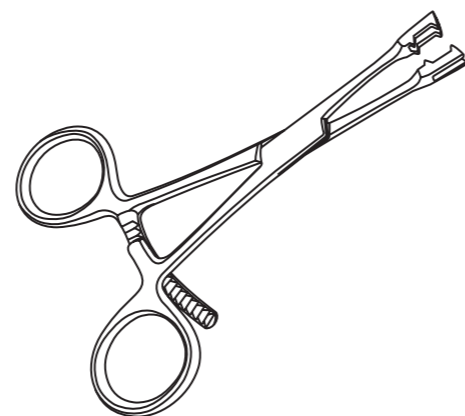

Implant Cutters cont.

Close cut cutter, using human force only to cut.

Order Code	Description
IC-16-215	Implant Cutter Stainless 1.6mm Capacity 215mm Long

Oblique jaw makes it a useful cutter.

Order Code	Description
IC-22-22-OB	Implant Cutter Oblique Jaw max cut 2.2mm 220mm Long

Larger close cut option.

Order Code	Description
IC-CC-25-23	Implant Cutter Close Cut max cut 2.5mm 230mm Long

Large straight cut implant cutter.

Order Code	Description
IC-3-26	Implant Cutter Compound Action max cut 3mm 260mm Long

Safety pin/wire cutter that cuts smoothly inside the tube holding the cut end safely inside. Extendable handles give you extra leverage.

Order Code	Description
IC-SP-4-32	Safety Pin/Wire Cutter up to 4mm. Handles Extend to 470mm

Extra large implant cutter with detachable handles.

Order Code	Description
IC-4-49	Large Implant Cutter with Detachable Handles cuts to 4mm 490mm Long with T.C. Jaws

T.C. = Tungsten Carbide Tip.

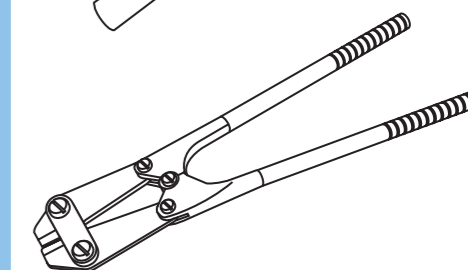
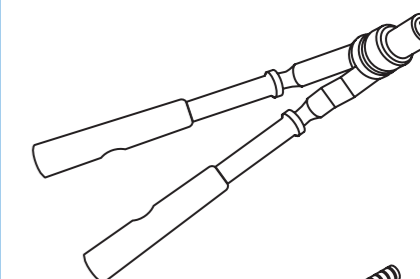
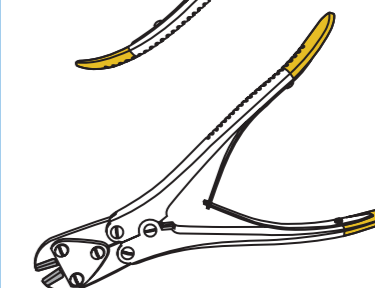
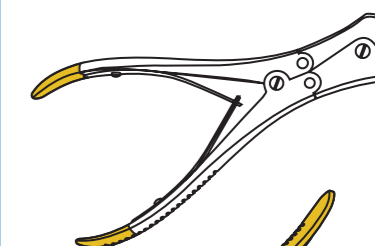
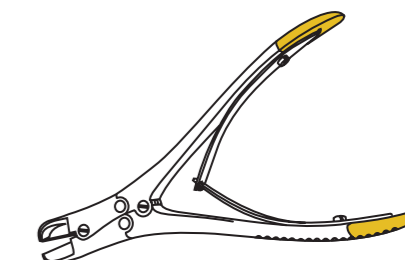
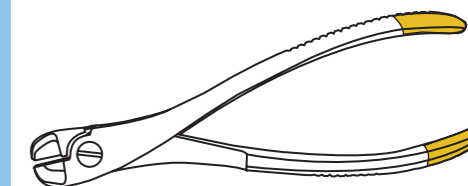

Periosteal Elevators

Very useful instruments for orthopaedic, spinal and dental work, with a range of tips to cover even the most delicate procedure.

Order Code	Description
PE-2/3-18	Periosteal Elevator 2/3mm 180mm
PE-4/7-20	Periosteal Elevator 4/7mm 200mm
PE-F-5-18	Freer Periosteal Elevator 5mm, 180mm
PE-5-18-CV	Periosteal Elevator 5mm Curved Tip 180mm
PE-5-18-SQ	Periosteal Elevator 5mm Square Tip 180mm
PE-6-18-CV	Periosteal Elevator 6mm Curved Tip 180mm
PE-6-18-SQ	Periosteal Elevator 6mm Square Tip 180mm

Molt

Order Code	Description
PE-M-2.5/4.5-20	Molt Periosteal Elevator 2.5/4.5mm 205mm
PE-MOLT	Modified Molt Periosteal Elevator

Freer

Order Code	Description
PE-FREER	Modified Freer Periosteal Elevator

Spinal Scalers

Order Code	Description
SC-JQ-16	Jaquette Spinal Scaler
SC-YG-17	Younger Atraumatic Spinal Scaler 170mm

Rosens Mobiliser

Order Code	Description
RS-MOB-16	Rosens Mobiliser 160mm

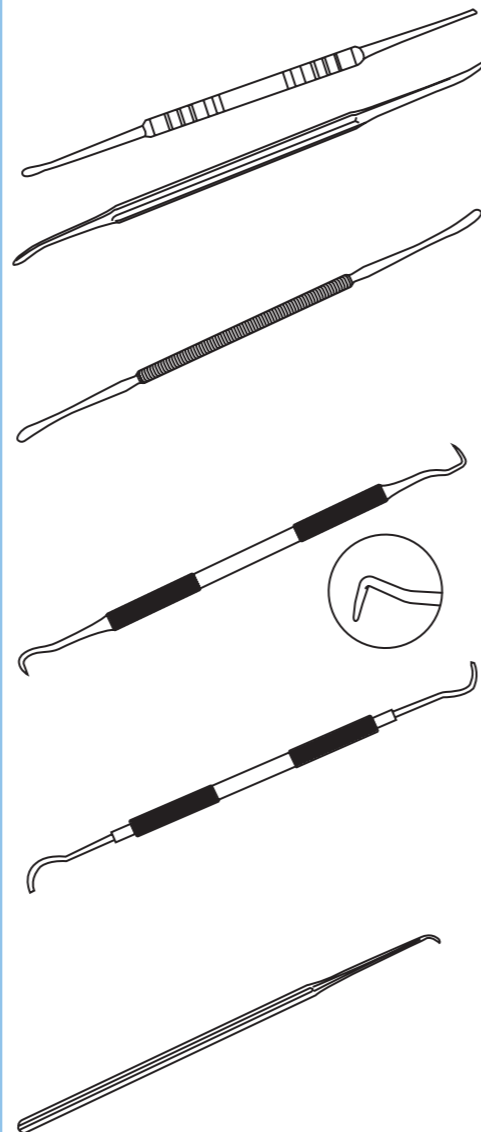
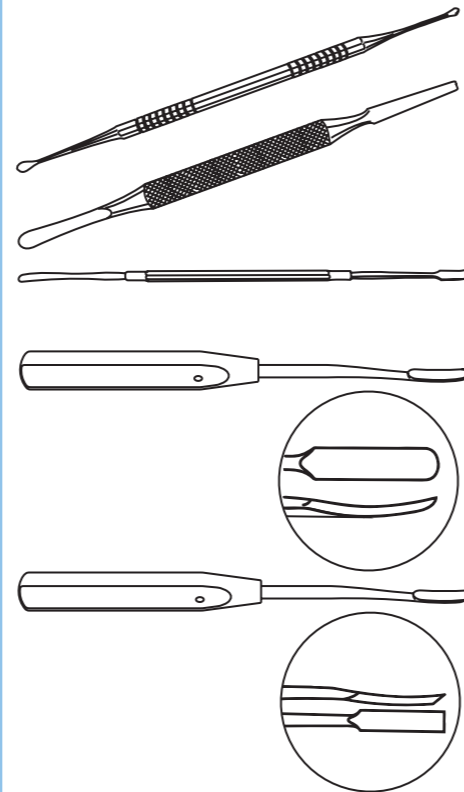

Volkman Scoops

Useful instrument for harvesting bone or debriding devitalised tissue. Double ended version offers great value where as single ended instruments give good grip control with its solid handle.

Order Code	Description
VS-DE-4/6	Volkman's Scoop Double Ended 4mm/6mm
VS-DE-5/6	Volkman's Scoop Double Ended 5mm/6mm
VS-DE-5/7	Volkman's Scoop Double Ended 5mm/7mm
VS-DE-6/8	Volkman's Scoop Double Ended 6mm/8mm

Order Code	Description
VS-SE-2	Volkman's Scoop Single Ended 2mm
VS-SE-3	Volkman's Scoop Single Ended 3mm
VS-SE-4	Volkman's Scoop Single Ended 4mm
VS-SE-6	Volkman's Scoop Single Ended 6mm
VS-SE-7	Volkman's Scoop Single Ended 7mm

Volkman Retractor

Volkman Retractor is a popular hand-held instrument that allows surgeons to manipulate tissues during distal limb surgeries, especially those involving small joints.

Order Code	Description
RT-VOLK-4-220	Volkman Retractor 4 Prong 220mm Long

Screw Extraction Trepine

A cost effective way of removing a screw with a sheared head. Designed to be slightly larger than the screw shaft, they allow the surgeon to drill round over the broken screw and remove it with forceps.

Order Code	Description
ET-SC-20	Extraction Trepine for 2.0mm Screws (2.7mm External Dia)
ET-SC-24	Extraction Trepine for 2.4mm Screws (3.5mm External Dia)
ET-SC-27	Extraction Trepine for 2.7mm Screws (3.5mm External Dia)
ET-SC-35	Extraction Trepine for 3.5mm Screws (4.5mm External Dia)
ET-SC-45	Extraction Trepine for 4.5mm Screws (5.5mm External Dia)
ET-SC-CASE	Storage Case for Extraction Trepines
ET-SC-SET	One of Each of Above in a Storage Case

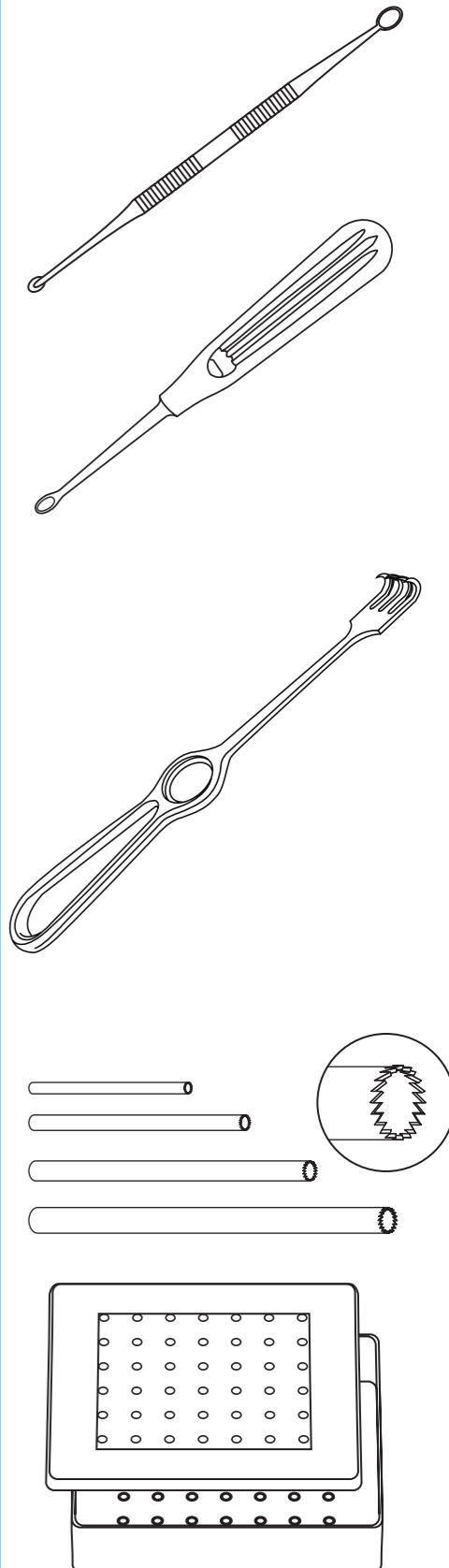

Rongeur Curved

Used for nibbling bone.

Order Code	Description
RG-SC-2	Small Curved Rongeur 2mm Bite
RG-SC-3	Small Curved Rongeur 3mm Bite
RG-SC-4	Small Curved Rongeur 4mm Bite

Compound action with a robust design for more aggressive use.

Order Code	Description
RG-RUSK-6-CV	Ruskin Rongeur 6mm Bite Curved

A fine rongeur useful for various procedures.

Order Code	Description
RG-F-MINI-3-CV	Mini Friedman Rongeur 3mm Bite Curved

Has a curved tip to aid vision, atraumatic to minimise trauma.

Order Code	Description
RG-LAM-2-16	Laminectomy Rongeur 2mm Bite 160mm
RG-LAM-3-16	Laminectomy Rongeur 3mm Bite 160mm
RG-LAM-4-16	Laminectomy Rongeur 4mm Bite 160mm

Order Code	Description
RG-DB-3-17	Duckbilled Daniels Rongeur 3mm Bite 177mm

Used as a spinal punch.

Order Code	Description
RG-SK-1MM	Smith Kerrsion Rongeur 1mm Bite
RG-SK-2MM	Smith Kerrsion Rongeur 2mm Bite
RG-SK-3MM	Smith Kerrsion Rongeur 3mm Bite

Useful set of Spinal Rongeurs covering most surgeons needs.

Order Code	Description
RG-SPIN-SET	Micro Spinal Rongeur set of 3 (Curved, Straight and Angled)

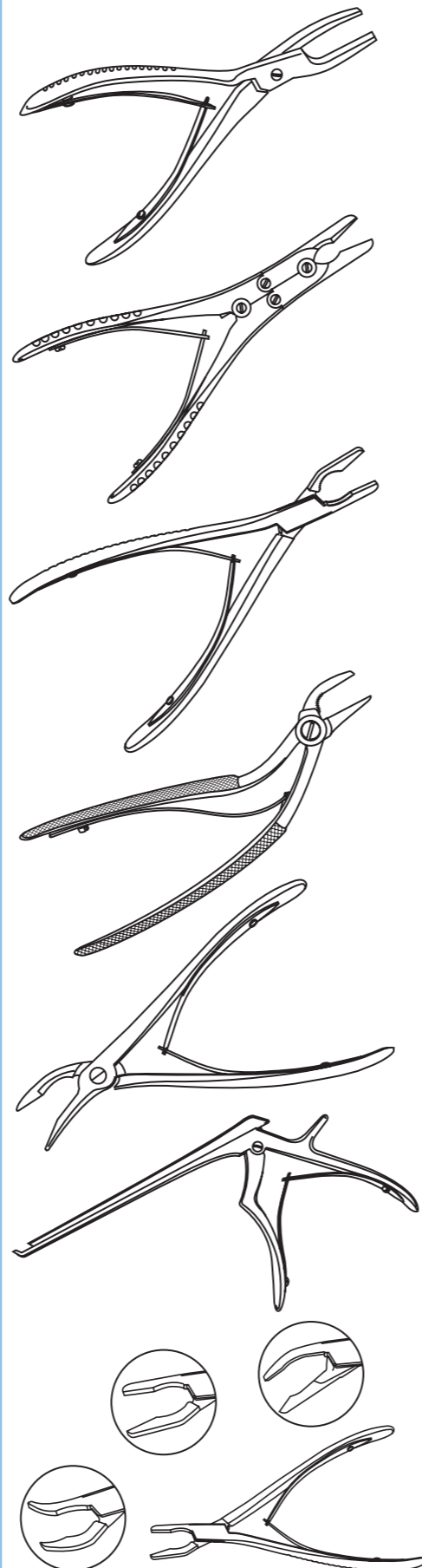

Parallel Action Pliers

Very useful kit for all orthopaedics, the teeth can hold and grab items such as pins, or for contouring plates, the cutting blades on the top will cut pins and wires up to 2mm.

Order Code	Description
PL-PA-17	Parallel Action Pliers (cuts to 2.0mm) 170mm

Pin Grips

Jaws are thin to get into narrow areas and can be locked onto pins and wires massively increasing pulling strength.

Order Code	Description
PN-GRIP	Pin Grips

Chuck and Handle

Used to insert pin by hand, fully autoclavable, Chuck will take pins up to 6mm in diameter.

Order Code	Description
CH-H-JT	Jacobs-Type Chuck & Anodised Handle

Webb Bolts

Consider using these when humeral transcondylar screws strip out.

Order Code	Description
WEB-M2-50	Webb Bolts M2 Thread 50mm Long
WEB-M3-80	Webb Bolts M3 Thread 80mm Long
WEB-M4-80	Webb Bolts M4 Thread 80mm Long
WEB-M5-80	Webb Bolts M5 Thread 80mm Long

Web Bolt Spanners

Order Code	Description
SP-4MM	Spanner for Webb Bolts M2
SP-5.5MM	Spanner for Webb Bolts M3
SP-7MM	Spanner for Webb Bolts M4
SP-8MM	Spanner for Webb Bolts M5

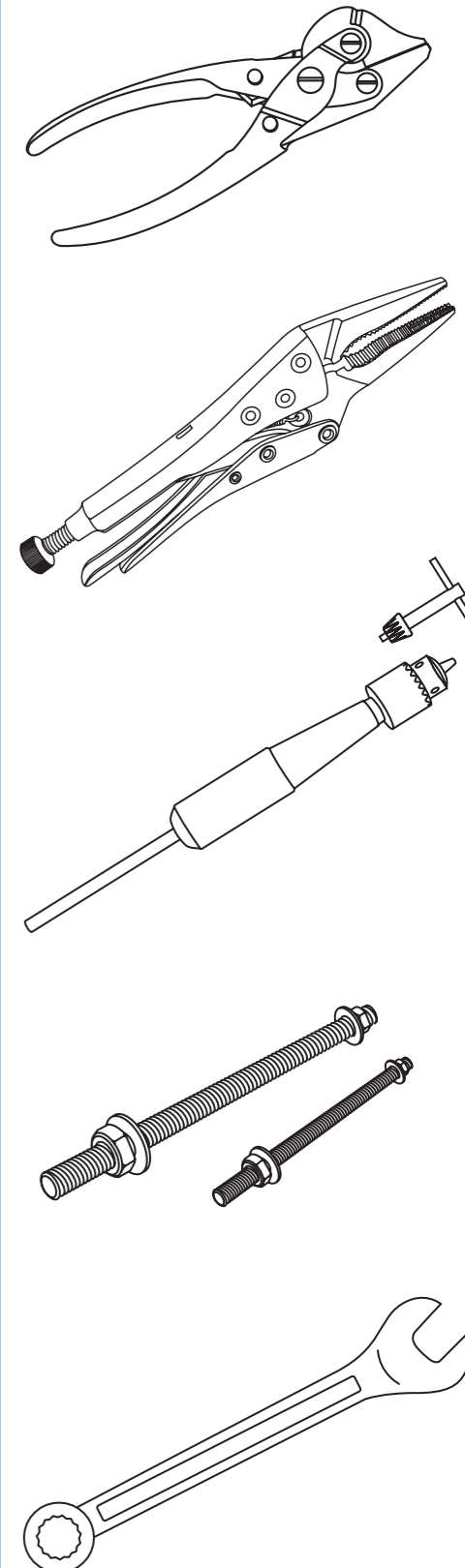

Retractor - Balfour

The standard veterinary retractor for abdominal work. Available in 3 sizes to cover most veterinary needs.

Commonly used veterinary retractor has two movable blades on the horizontal and vertical axis that can be locked into position.

Order Code	Description
RT-BAL-9	Balfour Small 90mm Spread
RT-BAL-14	Balfour Medium 140mm Spread
RT-BAL-18	Balfour Standard 180mm Spread
RT-BAL-LR	Balfour Locking Ring

Gosset Retractor

Less intrusive than the Balfours makes it useful kit for more specialist procedures.

Order Code	Description
RT-GOS-10	Gosset Retractor 100mm Spread
RT-GOS-14	Gosset Retractor 140mm Spread

Caspar Modular Retractor

Modular retractor with 6 interchangeable blades.

Order Code	Description
RT-CASP-MOD	Caspar Modular Retractor

Finsen Retractor

Designed for use in small incisions, this retractor is spring-loaded with pronged tips.

Order Code	Description
RT-FIN-130	Finsen Retractor

Weitlander Retractor

Order Code	Description
RT-WE-14	Weitlander Retractor 140mm

Finochietto Rib Retractor

Finochietto retractors are also called rib spreaders as they can be used for thoracic procedures for separating the ribs.

Order Code	Description
RT-RIB-FCN-LGE	Finochietto Rib Retractor Large Spread 130mm

Langenbeck Retractor

Order Code	Description
RT-LAN-13-20	Langenbeck Retractor 13mm Blade 200mm Long

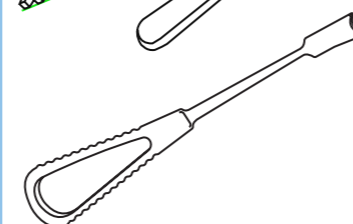
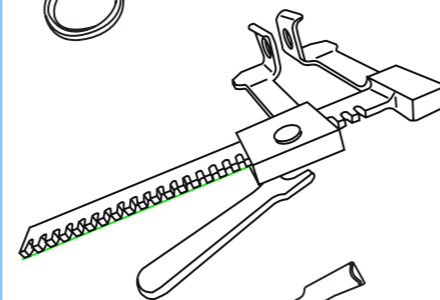
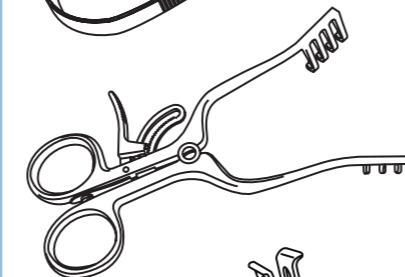
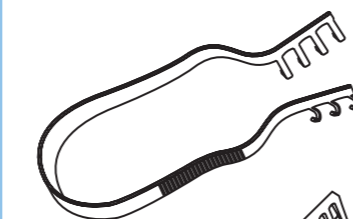
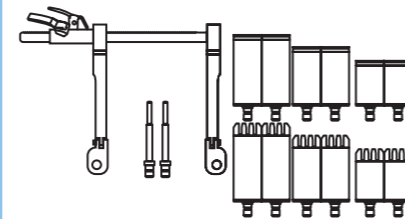
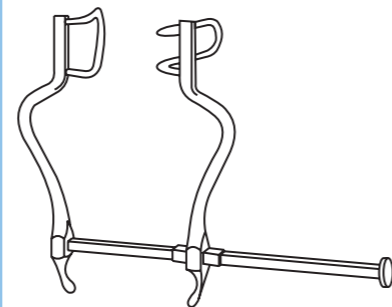
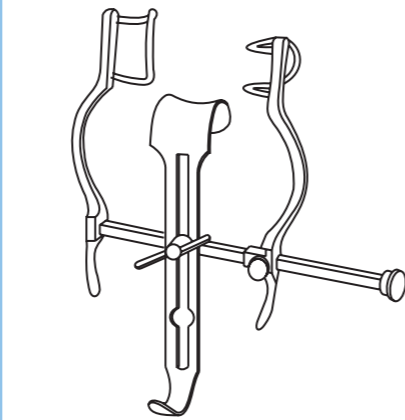

Wire/Pin Bender

Has a hole in each end that fit a range of pins up to 2mm allowing wires and pins to be bent over after insertion, securing it better to the bone.

Order Code	Description
WB-140	Wire/Pin Bender 140mm

Wire Contouring Pliers

Small nosed pliers that are used to shape wires. There is a small cutter to trim soft wires if required.

Order Code	Description
PL-WC-15	Wire Contouring Pliers (0.9mm-2.0mm Wires) 150mm

Wire Passers

Used for passing wires around bones whilst causing minimal tissue damage.

Order Code	Description
WP-20	Wire Passer 20mm Diameter
WP-30	Wire Passer 30mm Diameter
WP-40	Wire Passer 40mm Diameter

Wire/Pin Punch

Used with a mallet, one end has a small pointed tip that is used to drive the wire/pin end that is sticking out into the bone once it has been cut.

Order Code	Description
WP-P-13	Wire/Pin Punch 130mm
WP-P-S-13	Small Pin Punch 1.6mm Tip

Wire Twister Cutters

Strong needle holder type instrument with serrated grip for holding and twisting wire and a cutting edge for trimming the wire when required. The T.C. jaw version offers extra tool life whereas the standard version offers an extra hole behind the jaws for the wire to pass through.

Order Code	Description
WTC	Wire Twister/Cutter Std
WTC-TC	Wire Twister/Cutter T.C. Jaws

T.C. = Tungsten Carbide

Cerclage Button

Where screw placement is not suitable in 3.5mm Compression Plates a cerclage button can be added to maintain plate strength. The button has a groove in the head to allow it to be secured with cerclage wire.

Order Code	Description
CER-35	Single Cerclage Button (for 3.5mm DCP)

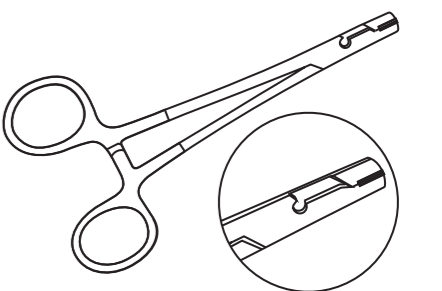
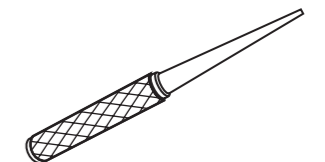
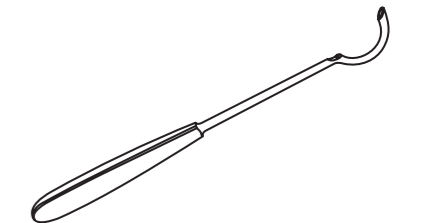
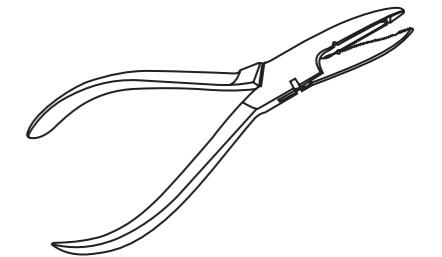
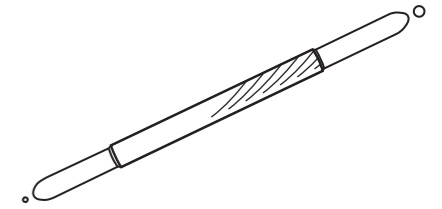

Orthopaedic Cerclage Wire

Order Code	Description
OW-04-REEL	Orthopaedic Cerclage Wire - 0.3mm 10m
OW-05-REEL	Orthopaedic Cerclage Wire - 0.45mm 10m
OW-06-REEL	Orthopaedic Cerclage Wire - 0.56mm 10m
OW-07-REEL	Orthopaedic Cerclage Wire - 0.7mm 10m
OW-08-REEL	Orthopaedic Cerclage Wire - 0.8mm 10m
OW-09-REEL	Orthopaedic Cerclage Wire - 0.9mm 10m
OW-10-REEL	Orthopaedic Cerclage Wire - 1.0mm 10m
OW-12-REEL	Orthopaedic Cerclage Wire - 1.2mm 10m
OW-15-REEL	Orthopaedic Cerclage Wire - 1.5mm 10m

Useful tool for tightening cerclage wire, simply hook the wire loop against the eye and twist.

Order Code	Description
WLT-12	Wire Loop Tightener for Cerclage Wire

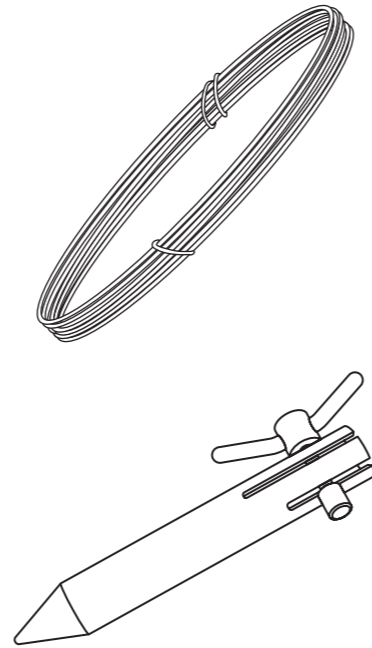

Washers

Spikey washers are used for a number of different procedures such as reattaching ligaments or to secure grafts.

Order Code	Description
WAS-15-20	Washer for use with 1.5 - 2.0 Screws ID2.2 OD5.0 W1.2
WAS-24-27	Washer for use with 2.4 - 2.7 Screws ID3.0 OD7.0 W1.2
WAS-35-40	Washer for use with 3.5 - 4.0 Cortical Screw ID4.2 OD7.0 W1.2
WAS-45	Washer for use with 4.5 Cortical Screw ID5.9 OD12.8 W4.6
WAS-24-TTA	2.4 Titanium TTA Washer. ID2.7 OD5.0 W1.0

Order Code	Description
WAS-20-SP	2.0mm Spikey Washer (single)
WAS-27-SP	2.7mm Spikey Washer (single)
WAS-3540-SP	3.5-4.0mm Spikey Washer (single)
WAS-45-SP	4.5mm Spikey Washer (single)

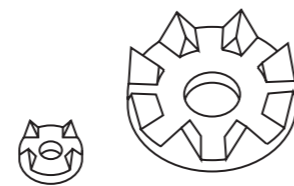
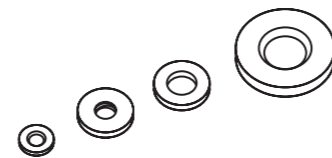

4.5mm Cortical Nut

Used to anchor a screw where the bone density is poor.

Order Code	Description
45N	Hexagonal Nut for 4.5 Cortical Screw

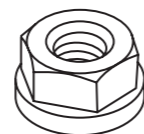

Arthroscopy

Exposure of the medial meniscus for examination and treatment is never easy. Many instruments have been developed for this purpose. The original technique required a Hohman to advance the tibia but Hohmans are not designed for the purpose and can cause trauma to both tibia and trochlea. The original stifle lever addresses these issues but is a little bulky for arthroscopic use. The arthroscopic version is finer, longer, and has a substantial Teflon handle allowing better manipulation of the joint. Due to demand we now offer a small range of specialist arthroscopy instruments to help with your requirements.

Order Code	Description
SL-ASL-280	Arthroscopic Stifle Lever 280mm
FC-RG-A-20-12	Arthroscopic Universal Rongeur and Grasping Forceps

Order Code	Description
OS-GD-2	Gordon Coronoid Osteotome 2mm

Order Code	Description
MR-ART-20-21	Arthroscopy Marking Rod 200mm - 2.1mm
SP-CU-ART-20	Arthroscopy Spoon Curette 200mm
KN-ART-BN-20	Arthroscopy Banana Knife 200mm
CU-CAN-22-23	Arthroscopy Curette Cannulated 220mm - 2.3mm
TR-SET	Arthroscopic Trochar Set 2.2/2.8/3.5/4.2mm

Order Code	Description
MEN-ART-KN-20	Arthroscopy Meniscus Knife 200mm
MN-H-1-190	Meniscus Probe/Nerve Hook 1.0mm
MN-H-2-220	Meniscus Probe/Nerve Hook 2.0mm



Arthroscopy cont.

Order Code	Description
FC-BIO-SET	Arthroscopic Biopsy Set with Detachable Tips

Order Code	Description
PR-ART-20-10	Arthroscopy Probe 200mm – 1.0mm

Forceps - Grasping

For grasping small items that are lodged such as grass seeds in ear canals. The fine tip version offers a very small end for more delicate areas. We also offer a flexible version which is particularly useful when used with an otoscope speculum.

Order Code	Description
FC-G-12	120mm Length Grasping Forceps
FC-G-17	170mm Length Grasping Forceps
FC-G-22	220mm Length Grasping Forceps
FC-G-12-FINE	120mm Length Grasping Forceps Fine Tip
FC-G-17-FINE	170mm Length Grasping Forceps Fine Tip
FC-G-22-FINE	220mm Length Grasping Forceps Fine Tip

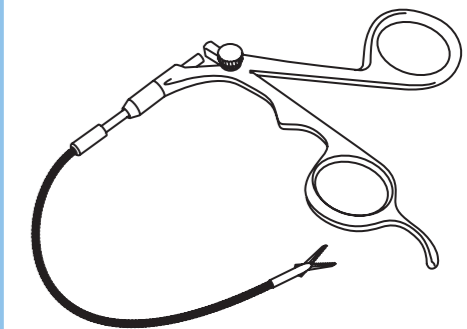
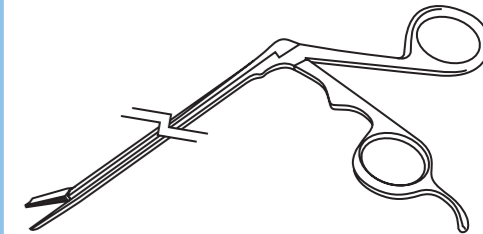

Arthroscopic Grasping Forceps

Extremely useful for hard to reach areas such as with a Speculae.

Order Code	Description
FC-G-17-FLEX	170mm Length Grasping Forceps Flexible

Order Code	Description
FC-AG-A-20-12	Arthroscopic Grasping Forcep Alligator Tip 2.0mm - 120mm Long
FC-AG-A-27-12	Arthroscopic Grasping Forcep Alligator Tip 2.7mm - 120mm Long
FC-AG-H-27-12	Arthroscopic Grasping Forcep Hooked Tip 2.7mm - 120mm Long

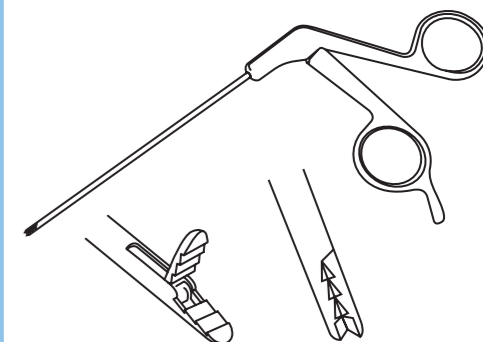

Arthroscopic Kit in Box

Order Code	Description
KIT-ART-SET	Arthroscopic Kit in Box



Arthroscopic Kit in Box cont.

Order Code	Description
KIT-ART-SET	Arthroscopic Kit in Box

Veterinary Arthroscopy Set Detail

This set consists of 25 items.

Sr.	Item Description	Pcs
00	Veterinary Arthroscopy Set	
01	Alligator Grasping Forceps, Length = 12.0 cm, 2.0 mm	1Pcs
02	Alligator Grasping Forceps, Length = 12.0 cm, 2.7 mm	1Pcs
03	Universal Grasping Forceps, Length = 12.0 cm, 2.0 mm	1Pcs
04	Universal Grasping Forceps, Length = 12.0 cm, 2.7 mm	1Pcs
05	Hooked Scissor Straight, Length = 12 cm, 2.7 mm	1Pcs
06	Knee Retractor With PTFE Handle	1Pcs
07	Spoon Curette, Length = 20.0 cm	1Pcs
08	Head Burr, Length = 19.3 cm, Tip = 2.3 mm	1Pcs
09	Probe, Length = 20.0 cm, Tip = 1.0 mm	1Pcs
10	Meniscus Knife, Length = 20.0 cm	1Pcs
11	Banana Knife, Length = 20.0 cm	1Pcs
12	Gordon Coronoid Osteotome, Size = 2 mm	1Pcs
13	Gordon Coronoid Osteotome, Size = 4 mm	1Pcs
14	Meniscus Push Knife, Length = 22.0 cm, Tip = 2.0 mm	1Pcs
15	Meniscus Hook Knife, Length = 22.0 cm, Tip = 2.0 mm	1Pcs
16	Maniscus Probe, Length = 22.0 cm, Tip = 2.0 mm	1Pcs
17	Curette with hole, Length = 20.0 cm, Tip = 2.3 mm	1Pcs
18	Biopsy Forceps with 4 detachable tips Tip = Ø 2.7 mm, Ø 3.5 mm, 5 x 2.7 mm, 5 x 3.7 mm	1Set
19	Small Join Distractor, Length = 10.0 cm, Tip Dia. = 3 mm	2Pcs
20	Trocar Set, Size = 2.2 mm / 2.8 mm / 3.5 mm / 4.2 mm	1Set
21	Trocar Set	1Set
22	Arthroscopy Trocars, Length = 7.0 cm, Ø 3.5 mm	1Pcs
23	Arthroscopy Trocars, Length = 7.0 cm, Ø 4.5 mm	1Pcs
24	Arthoscopic Distractor, Max. Pin Dia. = 3.2 mm	1Pcs
25	Arthroscopy Marking Rod, Length = 20.0 cm, 2.1 mm	1Pcs

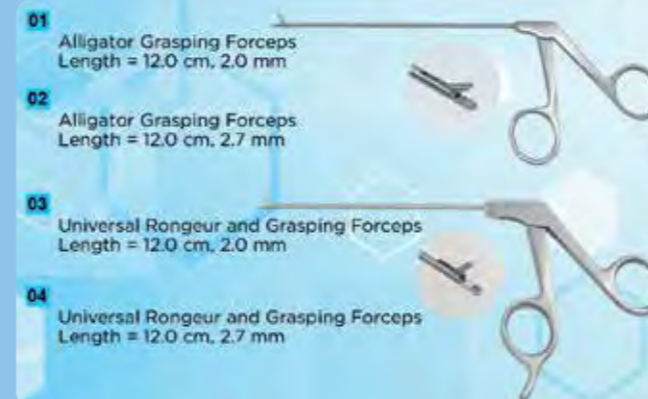

Arthroscopic Kit in Box cont.

Order Code	Description
KIT-ART-SET	Arthroscopic Kit in Box

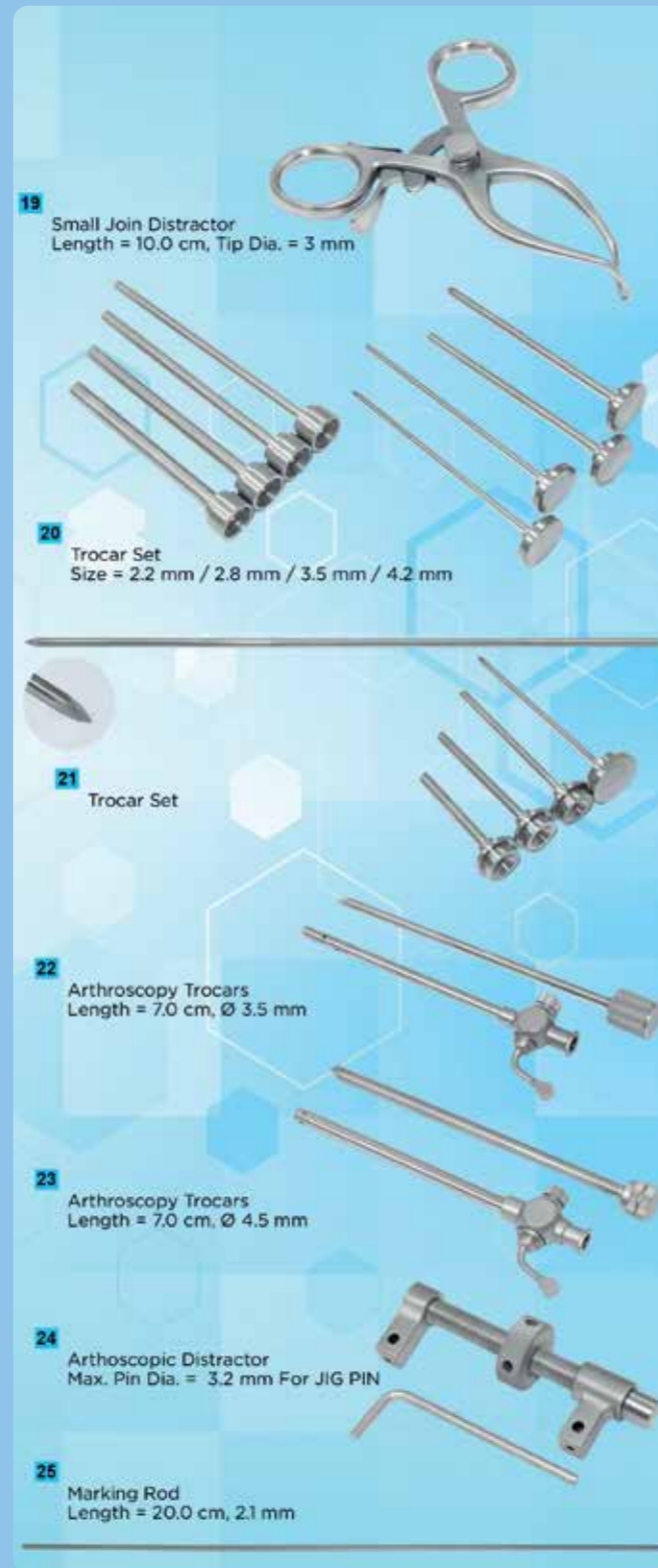

Drills and Taps

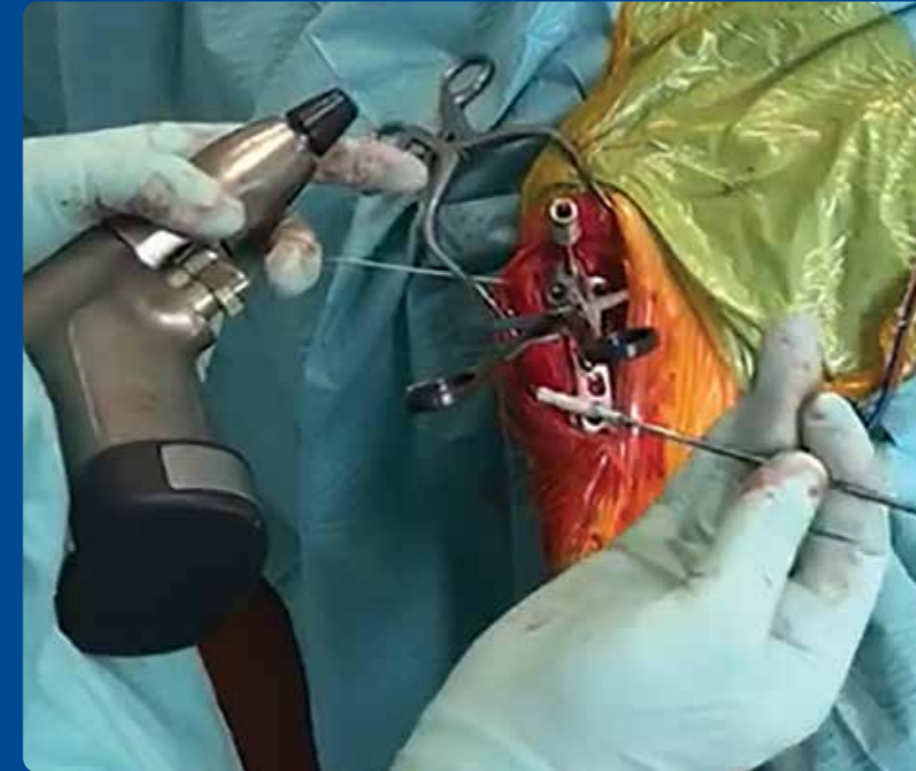

The drilling of bone is ubiquitous in many fields of surgery including orthopaedics, neurosurgery, craniomaxillofacial and ear nose and throat (ENT). A cylindrical tunnel is typically prepared in bone using a surgical drill-bit to accommodate a screw or other threaded device for rigid fixation, which is provided by the integration of bone (cancellous and/or cortical) with the screw threads. In this configuration bone screws are resistant to axial and shear forces, as well as bending moments and therefore suited to the load-bearing function of the skeleton during locomotion.

Standard Drill Bits

We have added the most common sizes and lengths to our standard drill range and offer a set price for all sizes. These drills offer excellent value.

Order Code	Diameter	Total Length	Flute Length
DRL-11-060	1.1	60	25
DRL-11-080	1.1	80	25
DRL-15-060	1.5	60	30
DRL-15-080	1.5	80	30
DRL-18-080	1.8	80	30
DRL-18-110	1.8	110	30
DRL-20-080	2.0	80	40
DRL-20-110	2.0	110	40
DRL-25-100	2.5	100	50
DRL-25-150	2.5	150	50
DRL-27-100	2.7	100	50
DRL-27-150	2.7	150	50
DRL-32-170	3.2	170	60
DRL-35-170	3.5	170	60
DRL-40-170	4.0	170	60
DRL-45-170	4.5	170	60

Order Code	Diameter	Total Length	Flute Length
DRL-QR-11-060	1.1	85	25
DRL-QR-11-080	1.1	105	25
DRL-QR-15-060	1.5	85	25
DRL-QR-15-080	1.5	105	30
DRL-QR-18-080	1.8	105	40
DRL-QR-18-110	1.8	135	40
DRL-QR-20-080	2.0	105	40
DRL-QR-20-115	2.0	140	40
DRL-QR-24-100	2.4	125	50
DRL-QR-25-100	2.5	125	40
DRL-QR-25-150	2.5	175	50
DRL-QR-27-100	2.7	125	40
DRL-QR-27-150	2.7	175	40
DRL-QR-27-170	2.7	195	60
DRL-QR-28-150	2.8	175	40
DRL-QR-32-170	3.2	195	60
DRL-QR-35-170	3.5	195	60
DRL-QR-40-170	4.0	195	60
DRL-QR-45-170	4.5	195	60



Evodurance® Drill Bits

Our popular Evodurance® range has been improved, they still cut quickly and precisely as before but they have been strengthened to ensure even the most heavy-handed surgeon can use them. Drills are coated in TiN (Titanium Nitride).

Order Code	Description
EDB-QR-15-080	1.5mm Evodurance® Drill Bit AO Quick Release. Working Length 80mm
EDB-QR-18-080	1.8mm Evodurance® Drill Bit AO Quick Release. Working Length 80mm
EDB-QR-20-110	2.0mm Evodurance® Drill Bit AO Quick Release. Working Length 110mm
EDB-QR-25-150	2.5mm Evodurance® Drill Bit AO Quick Release. Working Length 150mm
EDB-QR-27-150	2.7mm Evodurance® Drill Bit AO Quick Release. Working Length 150mm
EDB-QR-28-150	2.8mm Evodurance® Drill Bit AO Quick Release. Working Length 150mm

These sizes are also available in plain shank; contact us for further information.

We recommend the use of drill stops with these drills due to fast cutting action.

Drill Stop Set

Comprises four stoppers in an autoclavable case; simply choose the nearest stopper to your drill bit and lock it off at the required drill depth.

Order Code	Description
DR-ST-SET	Drill Stop Set in Stainless Steel Case; for Drill Sizes 2.0, 2.5, 2.7, 3.2, 3.5, 4.5

Drill Bit - Anti Skid

Standard tipped drills can slip or skid when making the initial entry into the bone especially when the angle differs from 90 degrees. Anti skid drills have a very sharp point on the end which bites into the bone and holds the drill in place, ensuring the hole is exactly where you need it.

Order Code	Diameter	Total Length
DRL-AS-15-R	1.5	60
DRL-AS-18-R	1.8	80
DRL-AS-20-R	2.0	100
DRL-AS-24-R	2.4	115
DRL-AS-25-R	2.5	130
DRL-AS-27-R	2.7	130
DRL-AS-32-R	3.2	130
DRL-AS-35-R	3.5	130

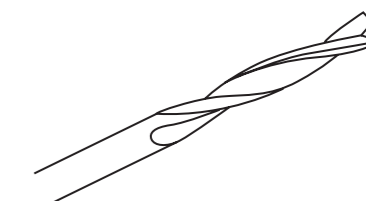
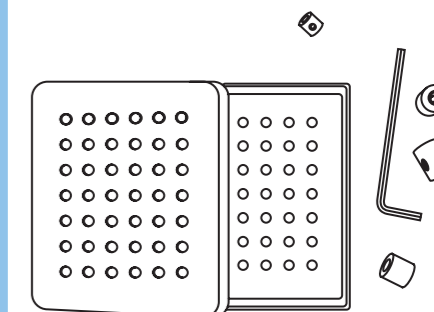

Drill Bit - Cannulated

For drilling over A-wires when drill hole angle and site are critical.

Order Code	Description	Length
DRL-CAN-25-130	Drill Bit 2.5mm with 1.1mm Cannulation	130mm
DRL-CAN-32-130	Drill Bit 3.2mm with 1.1mm Cannulation	130mm
DRL-CAN-35-130	Drill Bit 3.5mm with 1.1mm Cannulation	130mm

Drill Bit - Cannulated with QC Tip

For drilling over A-wires when drill hole angle and site are critical.

Order Code	Description	Length
DRL-QR-CAN-25-130	Drill Bit 2.5mm with 1.1mm Cannulation with QC Tip	130mm
DRL-QR-CAN-32-130	Drill Bit 3.2mm with 1.1mm Cannulation with QC Tip	130mm
DRL-QR-CAN-35-130	Drill Bit 3.5mm with 1.1mm Cannulation with QC Tip	130mm

Drill Storage Box

Marked to hold the following drill bits.

1.1, 1.5, 1.8, 2.0, 2.4, 2.5, 2.7, 3.2, 3.5, 4, 4.5

Order Code	Description
DR-BOX	Drill Box Empty
DR-BOX-FULL	Drill Box Complete with 1.1, 1.5, 1.8, 2.0, 2.4, 2.5, 2.7, 3.2, 3.5, 4.0, 4.5mm Drills

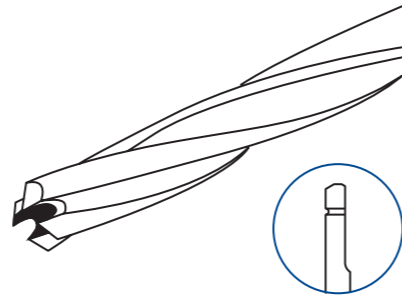
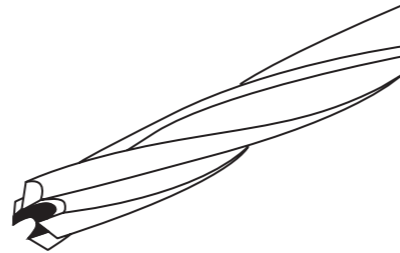

Taps Quick Release AO / Dental Fit

Taps are designed to cut a thread prior to screw placement. Removal of the material allows the screws to be placed in the bone much easier and reduces risk of stripping. N2 taps are hardened to last longer and the threads are cut with a sharp edge to aid the pre tapping process.

Order Code	Description
Cortical Taps	
TAP-QRD-15	1.5mm Cortical Tap with Dental Fitting
TAP-QRD-20	2.0mm Cortical Tap with Dental Fitting
TAP-QR-24	2.4mm Cortical Tap with AO Quick Fit
TAP-QR-27	2.7mm Cortical Tap with AO Quick Fit
TAP-QR-35	3.5mm Cortical Tap with AO Quick Fit
TAP-QR-45	4.5mm Cortical Tap with AO Quick Fit
TAP-QR-45L	4.5mm Cortical Tap Extra Long with AO Quick Fit
TAP-QR-55	5.5mm Cortical Tap with AO quick fit
Locking Taps	
TAP-QRD-LOC-20	2.0mm Locking Screw Tap with Dental Fitting
TAP-QR-LOC-24	2.4mm Locking Screw Tap with AO Quick Fit
TAP-QR-LOC-27	2.7mm Locking Screw Tap with AO Quick Fit
TAP-QR-LOC-35	3.5mm Locking Screw Tap with AO Quick Fit

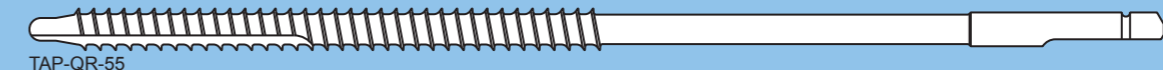
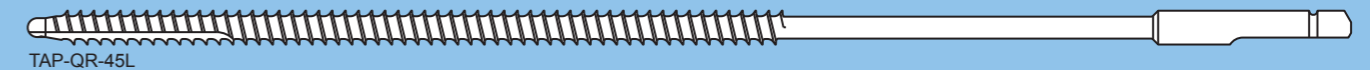
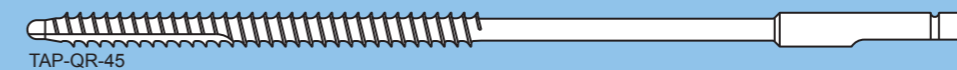

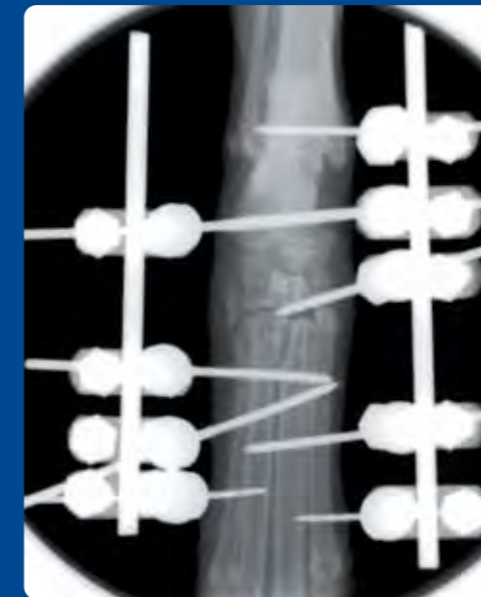
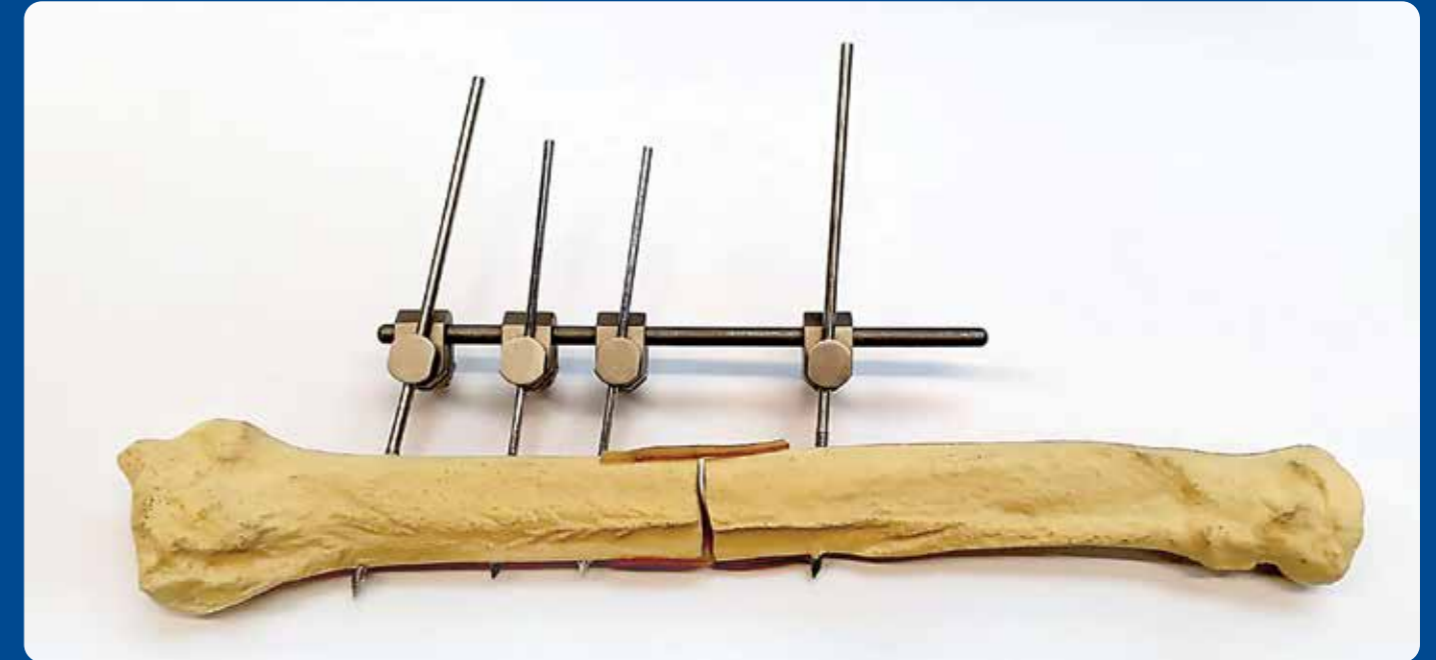

External fixation is a surgical method of immobilizing bones to allow a fracture to heal properly. It is used to provide stability to bone and soft tissue after a fracture, but can also be applied as a procedure to correct bone misalignment, restore limb length, or protect soft tissue after a serious burn or injury.

KE Clamps

Kirschner Ehmer is an Anderson splint clamp modified for veterinary use. N2 clamps are the stainless steel + type version which allows the clamp to take a wider range of pins than the standard KE clamps. Split clamps are also an option to allow extra clamps to be added once the construct is in position.

To see our discounted kits go to page 125.

KE+ Single Clamps

Order Code	Description
EFC-KE-SM	KE+ Clamp Small
EFC-KE-MED	KE+ Clamp Medium
EFC-KE-LG	KE+ Clamp Large

KE+ Double Clamps

Order Code	Description
EFC-KE-DBL-SM	KE+ Clamp Double Small
EFC-KE-DBL-MED	KE+ Clamp Double Medium
EFC-KE-DBL-LG	KE+ Clamp Double Large

KE+ Split Clamps

Order Code	Description
EFC-SPLIT-SM	KE+ Split Clamp Small
EFC-SPLIT-MED	KE+ Split Clamp Medium
EFC-SPLIT-LG	KE+ Split Clamp Large

External Fixation Table

For Spanners see page 45.

KE+	Bar size	Pin Range	Spanner
Small	3.2mm	1.1mm-3.2mm	7mm
Medium	4.8mm	1.6mm-4.0mm	8mm
Large	8.0mm	2.0mm-5.0mm	10mm

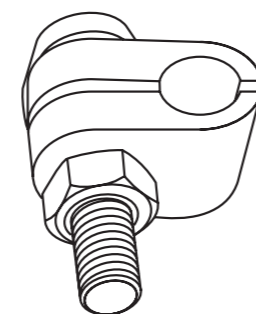
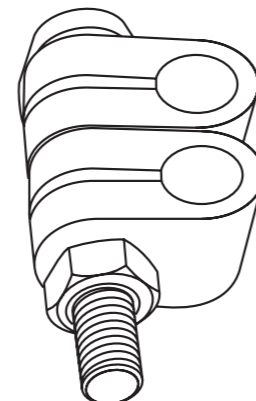
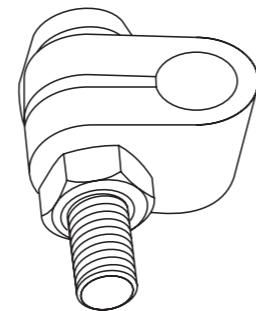

Ex-Fix Bars (Stainless Steel)

Used in small KE+ clamps and Mini SF clamps.

Order Code	Description
EFB-320-030	External Fixation Bar Ø3.2mm (1/8") x 30mm Long
EFB-320-050	External Fixation Bar Ø3.2mm (1/8") x 50mm Long
EFB-320-075	External Fixation Bar Ø3.2mm (1/8") x 75mm Long
EFB-320-100	External Fixation Bar Ø3.2mm (1/8") x 100mm Long
EFB-320-125	External Fixation Bar Ø3.2mm (1/8") x 125mm Long
EFB-320-150	External Fixation Bar Ø3.2mm (1/8") x 150mm Long

Used in medium KE+ clamps.

Order Code	Description
EFB-480-075	External Fixation Bar Ø4.8mm (3/16") x 75mm Long
EFB-480-100	External Fixation Bar Ø4.8mm (3/16") x 100mm Long
EFB-480-150	External Fixation Bar Ø4.8mm (3/16") x 150mm Long
EFB-480-200	External Fixation Bar Ø4.8mm (3/16") x 200mm Long
EFB-480-250	External Fixation Bar Ø4.8mm (3/16") x 250mm Long

Used in large KE+ clamps.

Order Code	Description
EFB-800-100	External Fixation Bar Ø8.0mm (5/16") x 100mm Long
EFB-800-150	External Fixation Bar Ø8.0mm (5/16") x 150mm Long
EFB-800-240	External Fixation Bar Ø8.0mm (5/16") x 240mm Long
EFB-800-340	External Fixation Bar Ø8.0mm (5/16") x 340mm Long

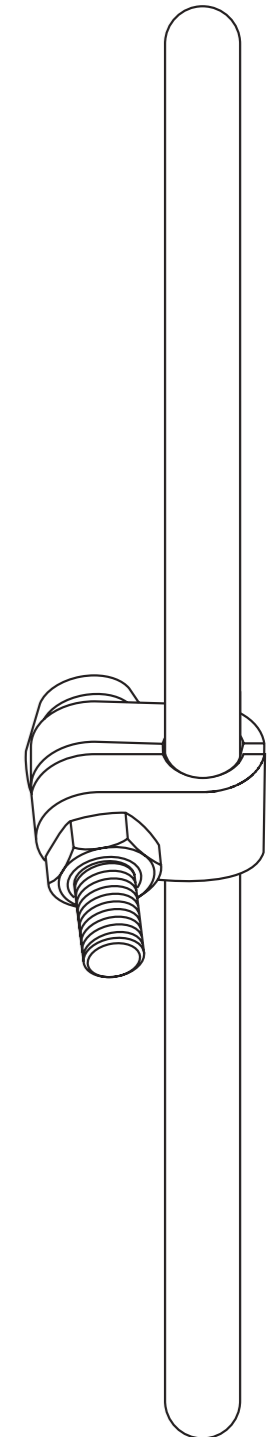

SF Clamps

Our Standard Fixator Clamps are made from T6 Aluminium and although slightly more bulky than KE+ clamps are much lighter. The added bonus with SF clamps is all clamps allow them to be split so extra clamps can easily be added to a frame for extra strength where needed. The design allows for a large pin choice on each size as well.

To see our discounted kits go to page 125.

Order Code	Description
EFC-SF-MINI	Standard Fixator SF Clamp Single - Mini
EFC-SF-SML	Standard Fixator SF Clamp Single - Small
EFC-SF-LG	Standard Fixator SF Clamp Single - Large

Order Code	Description
EFC-SF-DBL-MINI	Standard Fixator SF Clamp Double - Mini
EFC-SF-DBL-SML	Standard Fixator SF Clamp Double - Small
EFC-SF-DBL-LG	Standard Fixator SF Clamp Double - Large

SF Clamps	Bar size	Pin Range	Spanner
Mini	3.2mm	0.9mm-2.5mm	7mm
Small	6.35mm	2.0mm-3.2mm	8mm
Large	9.5mm	3.2mm-4.8mm	10mm

For spanners see page 65.

Ex-Fix Connecting Bars (Titanium)

Designed to fit the small SF clamps (middle size).

Order Code	Description
EFB-635-100T	External Fixation Bar Ø6.35mm (1/4") x 100mm Long Titanium
EFB-635-150T	External Fixation Bar Ø6.35mm (1/4") x 150mm Long Titanium
EFB-635-200T	External Fixation Bar Ø6.35mm (1/4") x 200mm Long Titanium
EFB-635-250T	External Fixation Bar Ø6.35mm (1/4") x 250mm Long Titanium

Ex-Fix Connecting Bars (Carbon Fibre)

Designed to fit the small SF clamps (middle size).

Order Code	Description
EFB-635-100C	External Fixation Bar Ø6.35mm (1/4") x 100mm Long Carbon
EFB-635-150C	External Fixation Bar Ø6.35mm (1/4") x 150mm Long Carbon
EFB-635-200C	External Fixation Bar Ø6.35mm (1/4") x 200mm Long Carbon
EFB-635-250C	External Fixation Bar Ø6.35mm (1/4") x 250mm Long Carbon
EFB-635-300C	External Fixation Bar Ø6.35mm (1/4") x 250mm Long Carbon

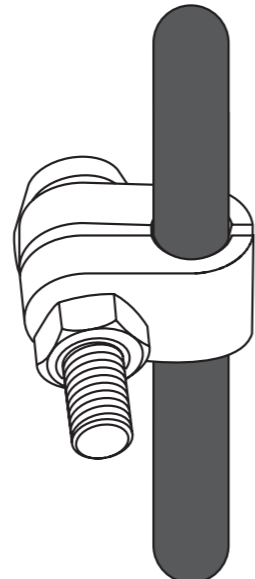
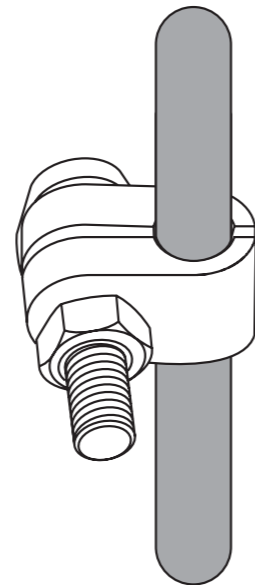
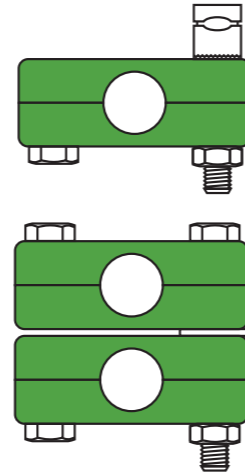

Ex-Fix Connecting Bars (Aluminium)

Aluminium bars are very strong and can be slightly bent where needed. Bending does reduce its overall strength. Designed to fit the large SF clamps.

Order Code	Description
EFB-950-100A	External Fixation Bar Ø9.5mm (3/8") x 100mm Long Aluminium
EFB-950-150A	External Fixation Bar Ø9.5mm (3/8") x 150mm Long Aluminium
EFB-950-200A	External Fixation Bar Ø9.5mm (3/8") x 200mm Long Aluminium
EFB-950-250A	External Fixation Bar Ø9.5mm (3/8") x 250mm Long Aluminium
EFB-950-300A	External Fixation Bar Ø9.5mm (3/8") x 300mm Long Aluminium

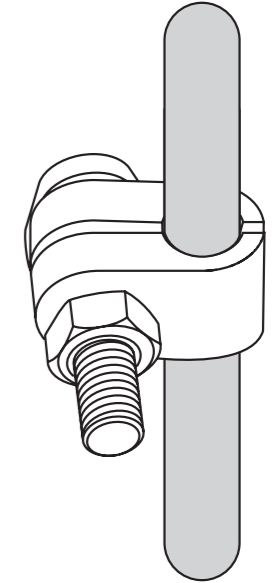

Ex-Fix Connecting Bars (Carbon Fibre)

Very strong and light. The carbon bars are easy to cut to size where needed and are radiolucent. Designed to fit the large SF clamps.

Order Code	Description
EFB-950-100C	External Fixation Bar Ø9.5mm (3/8") x 100mm Long Carbon
EFB-950-150C	External Fixation Bar Ø9.5mm (3/8") x 150mm Long Carbon
EFB-950-200C	External Fixation Bar Ø9.5mm (3/8") x 200mm Long Carbon
EFB-950-250C	External Fixation Bar Ø9.5mm (3/8") x 250mm Long Carbon
EFB-950-300C	External Fixation Bar Ø9.5mm (3/8") x 300mm Long Carbon

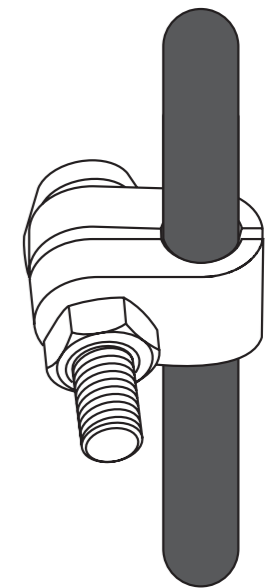

Autoclavable Spanners

Order Code	Description
SP-7MM	Mini SF External Fixation Spanner 7mm
SP-8MM	Small SF External Fixation Spanner 8mm
SP-10MM	Large SF External Fixation Spanner 10mm

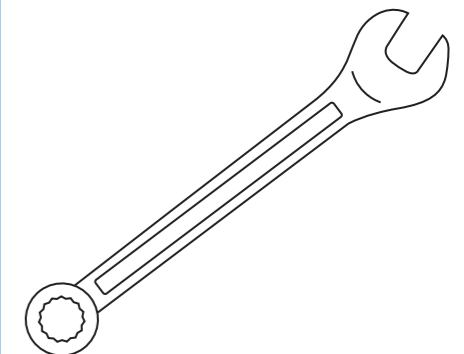

Wire Instruments

For wires see page 45 of the implant catalogue.

For wires up to 2.0mm. Used to bend the end of pins over so they're flatter to the bone.

Order Code	Description
WB-140	Wire/Pin Bender 140mm

Used to shape and cut both Kirschner wires and orthopaedic wires.

Order Code	Description
PL-WC-15	Wire Contouring Pliers (0.9mm-2.0mm Wires) 150mm

Used to pass wire round the bone causing minimal tissue injury.

Order Code	Description
WP-20	Wire Passer 20mm Diameter
WP-30	Wire Passer 30mm Diameter
WP-40	Wire Passer 40mm Diameter

Useful bit of kit, the tip is narrow and allows pins and wires to push the tip back into bone to protect it when using a mallet.

Order Code	Description
WP-P-13	Wire/Pin Punch 130mm
WP-P-S-13	Small Pin Punch 1.6mm Tip

Strong needle holder type instrument with serrated grip for holding and twisting wire and a cutting edge for trimming the wire when required. The T.C. jaw version offers extra strength whereas the standard version offers an extra hole behind the jaws for the wire to pass through.

Order Code	Description
WTC	Wire Twister/Cutter Standard
WTC-TC	Wire Twister/Cutter T.C. Jaws

T.C. = Tungsten Carbide

Used to protect the tissues around the drill or pin hole, the end is slit to allow it to be opened and removed after use.

Order Code	Description
EF-TPT	External Fixation Tissue Protector

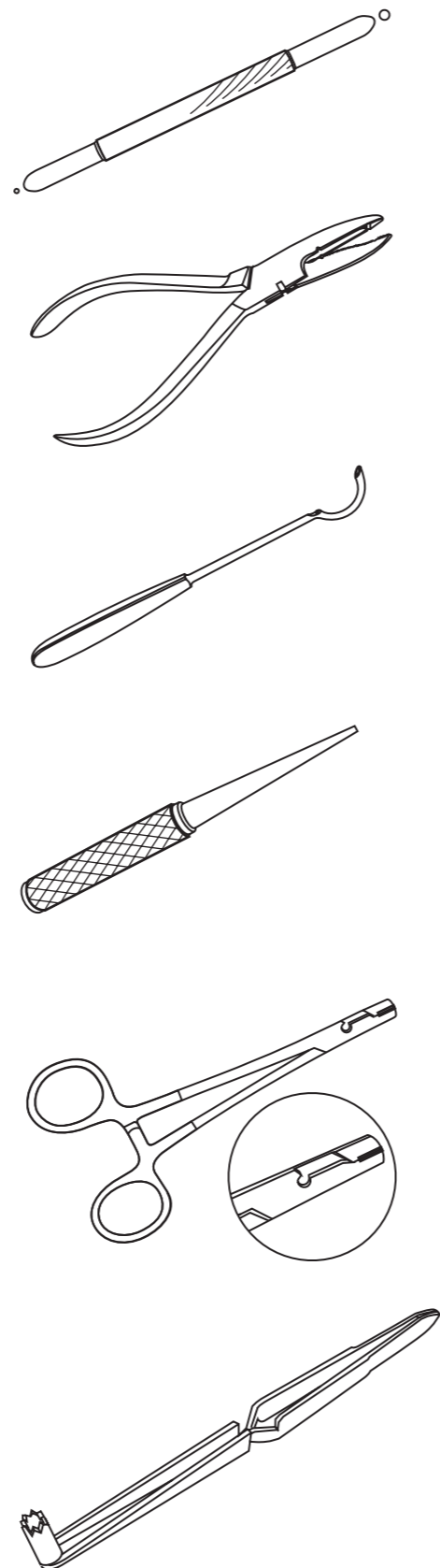

Implant Cutters

Ideally designed for cutting close to the bone with close cut finish.

Order Code	Description
IC-CC-15-15	Implant Cutter Close Cut max cut 1.5mm 150mm Long with T.C. Jaws
IC-CC-2-16	Implant Cutter Close Cut max cut 2.0mm 160mm Long with T.C. Jaws

Close cut cutter, using human force only to cut.

Order Code	Description
IC-16-215	Implant Cutter Stainless 1.6mm Capacity 215mm Long

Light use standard blade cutter.

Order Code	Description
IC-15-17	Implant Cutter max cut 1.5mm 170mm Long with T.C. Jaws
IC-22-23	Implant Cutter max cut 2.2mm 230mm Long

Oblique jaw makes it a useful cutter.

Order Code	Description
IC-22-22-OB	Implant Cutter Oblique Jaw max cut 2.2mm 220mm Long

Larger close cut option.

Order Code	Description
IC-CC-25-23	Implant Cutter Close Cut max cut 2.5mm 230mm Long

Large straight cut implant cutter.

Order Code	Description
IC-3-26	Implant Cutter Compound Action max cut 3mm 260mm Long

Safety pin/wire cutter that cuts smoothly inside the tube holding the cut end safely inside. Extendable handles give you extra leverage.

Order Code	Description
IC-SP-4-32	Safety Pin/Wire Cutter up to 4mm. Handles Extend to 470mm

Extra large implant cutter with detachable handles.

Order Code	Description
IC-4-49	Large Implant Cutter with Detachable Handles cuts to 4mm 490mm Long

T.C. = Tungsten Carbide Tip

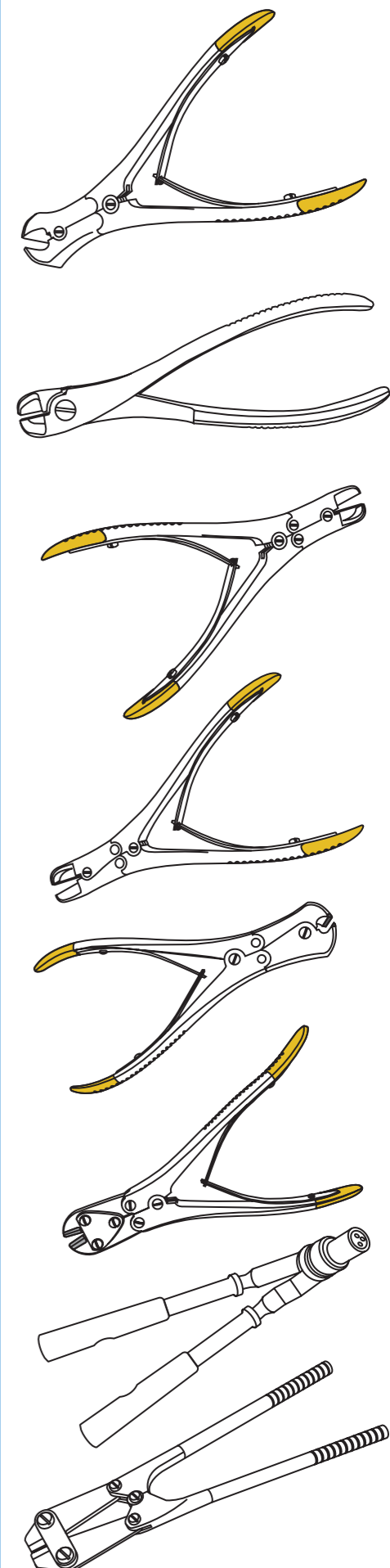

Wire/Pin Storage

A selection of storage options for pins and wires.

Designed to fit a selection of Kirschner wires in the tubes with space as well for a wire bender and pin punch allowing all the kit to be stored and autoclaved together. The size 12 is the same size as the 6 but the storage tubes are split into 2 sections. For Kirschner wires see page 49 of the implant catalogue.

Order Code	Description
KW-BOX-6	Kirschner Wire Box 6 Sizes
KW-BOX-12	Kirschner Wire Box 12 Sizes

Large tubes divided into 4 marked compartments. The end of the tube rotates and when lined up with the corresponding section allows them to drop through for use.

Order Code	Description
SD-W-SM	Small Wire Storage/Dispenser 0.9mm/1.1mm/1.25mm/1.4mm
SD-W-LG	Large Wire Storage/Dispenser 1.5mm/1.6mm/1.8mm/2.0mm

Basic storage tubes in different lengths. Perforated sides allow pins/wires to be sterilised in the tube for ease and safety.

Order Code	Description
ST-S-135	Storage Tube Diameter 10mm 135mm
ST-S-180	Storage Tube Diameter 10mm 180mm
ST-L-170	Storage Tube Diameter 18mm 170mm

Bone Pin Roll

Autoclavable IM pin bag that allows IM pin organization in a neat and easy-to-find fashion. For IM pins see page 48 of the implant catalogue.

The fold over lid ensures pins do not penetrate your sterilisation bags.

Order Code	Description
BP-SW-UNI	Autoclavable Pin Storage Bag

To contain all your kit together we have created this basic storage unit which comprises of outer box, lower tray for instruments and larger bars, and upper partitioned tray for clamps, pins and smaller bars.

Order Code	Description
KIT-BOX-EX-FIX	Box and 2 Trays for External Fixation Kits
KIT-BOX-EX-FIX-3	Kit Box with 3 Ex Fix Trays
KIT-TRAY-EMPTY	Tray Only Without Partitions (Fits in KIT-BOX-3)
KIT-TRAY-PART	Tray With Partitions (Fits in KIT-BOX-3)
KIT-BOX-3	Stainless Box 250 x 150 x 60mm

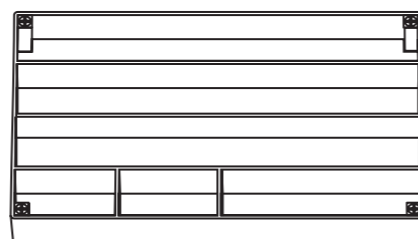
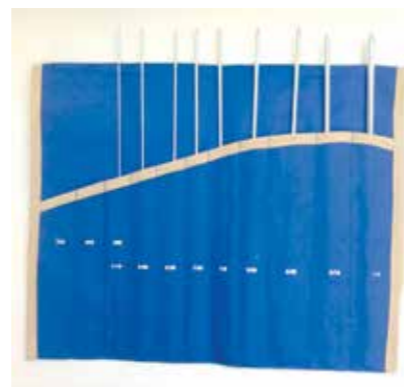
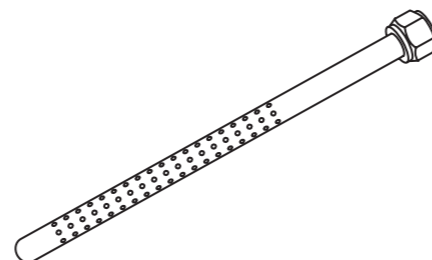
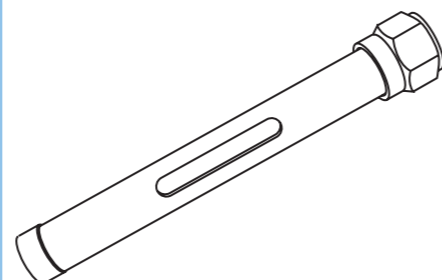
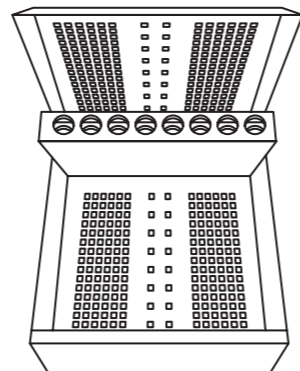

General Instruments



Handle Guide

Stainless steel – Standard instrument range.

Tungsten carbide tips – Tungsten carbide is extremely hard wearing meaning your instruments stay sharper for longer.

Supercut blades – One blade is covered in tiny serrations and the other blade is tapered. The serrations grip the tissue whilst the tapered edge cuts through it.

Tungsten carbide tips with supercut blades – The best cutting blades combined with the most hard wearing.

We now offer two extra instrument services

- Laser marking – should you want a practice or persons name added to the instrument or maybe the name of a certain kit it belongs in we can arrange that for you, simply mention it at the time of ordering.
- LZ-MARK £5.00 extra.
- Colour coating – our coloured instruments have been popular in the veterinary market either just for a bit of individuality or as a way of defining their use. Available in black, blue, gold and the popular rainbow options they can add a unique instrument option to our customers.
- CL-COAT £10.00 extra.

Please note that delivery will take longer for these items.

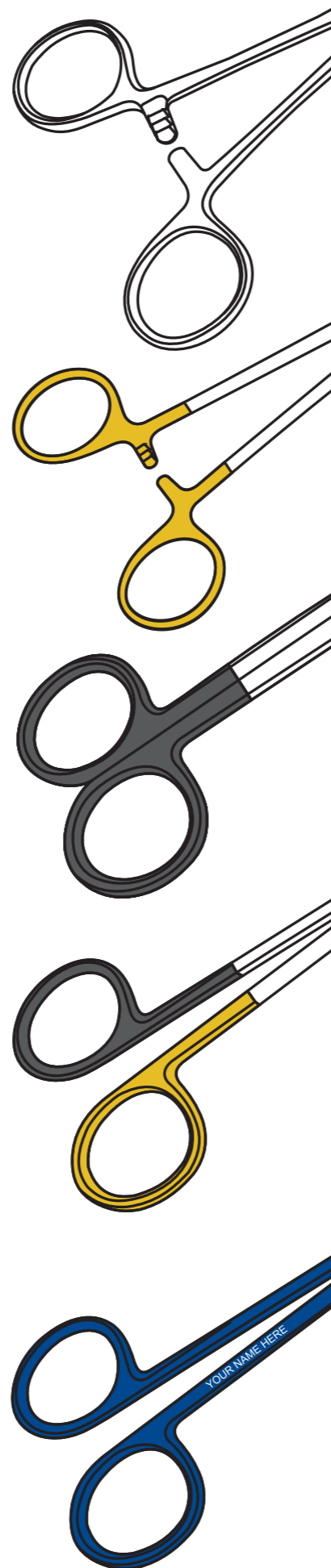

Needle Holders - Olsen Hegar

Commonly used needle holder/scissor comes with ratchet lock.

Order Code	Description
NH-OH-14	Olsen Hegar Needle Holders 140mm
NH-OH-16	Olsen Hegar Needle Holders 160mm
NH-OH-18	Olsen Hegar Needle Holders 180mm
NH-OH-14-TC	Olsen Hegar Needle Holders T.C. 140mm
NH-OH-16-TC	Olsen Hegar Needle Holders T.C. 160mm
NH-OH-18-TC	Olsen Hegar Needle Holders T.C. 180mm
NH-OH-20-SCTC	Olsen Hegar Needle Holders Super Cut T.C. 200mm

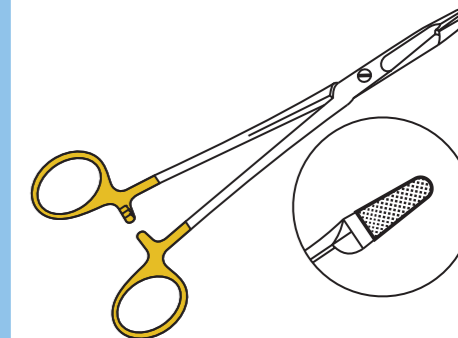

Needle Holders - Gillies

The offset handle is preferred by some surgeons as more comfortable over longer procedures, has the same needle holder/scissors as Olsen Hegars but cannot be locked as it has no ratchet.

Order Code	Description
NH-GL-14	Gillies Needle Holders 140mm
NH-GL-16	Gillies Needle Holders 160mm
NH-GL-12-TC	Gillies Needle Holders T.C. 125mm
NH-GL-14-TC	Gillies Needle Holders T.C. 140mm
NH-GL-16-TC	Gillies Needle Holders T.C. 160mm

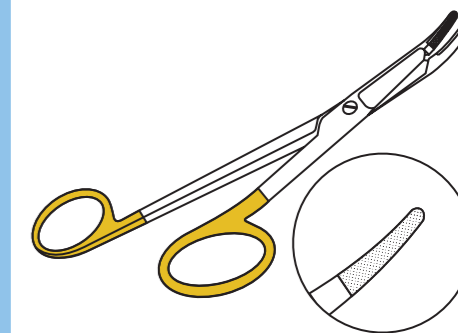

Needle Holders - Mayo Hegar

Similar in design to the Olsen Hegar type but without the scissor option.

Order Code	Description
NH-MH-14	Mayo Hegar Needle Holders 140mm
NH-MH-16	Mayo Hegar Needle Holders 160mm
NH-MH-18	Mayo Hegar Needle Holders 180mm
NH-MH-14-TC	Mayo Hegar Needle Holders T.C. 140mm
NH-MH-16-TC	Mayo Hegar Needle Holders T.C. 160mm
NH-MH-18-TC	Mayo Hegar Needle Holders T.C. 180mm
NH-MH-20-TC	Mayo Hegar Needle Holders T.C. 200mm

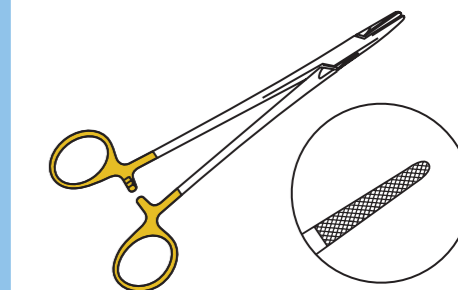

Narrower version of the Mayo Hegar.

Order Code	Description
NH-DB-17-TC	Debakey Needle Holders T.C. 175mm
NH-DB-20-TC	Debakey Needle Holders T.C. 200mm

T.C. = Tungsten Carbide.

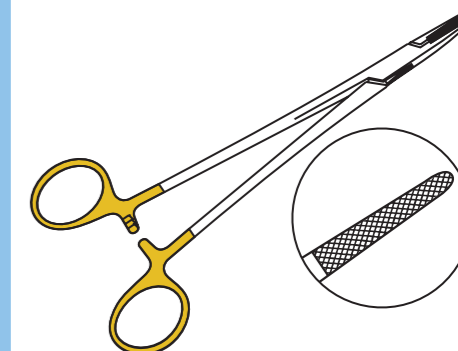

Needle Holders - McPhails

More delicate needle holder with slightly different design of spring loaded ratchet. Tips are steel and copper for a softer grip.

Order Code	Description
NH-MCPH-14	McPhails Needle Holder 140mm
NH-MCPH-16	McPhails Needle Holder 160mm
NH-MCPH-18	McPhails Needle Holder 180mm

Needle Holders - Castroviejo

Associated with delicate ophthalmic surgery but also useful for suture procedures. Available as just a needle holder or needle holder/scissors, comes with T.C. tips and also available as T.C. supercut.

Order Code	Description
NH-C-12-TC-ST	Castroviejo Needle Holder Straight T.C. 120mm
NH-C-15-TC-ST	Castroviejo Needle Holder Straight T.C. 150mm
NH-C-18-TC-ST	Castroviejo Needle Holder Straight T.C. 180mm

Order Code	Description
NH-S-C-15-TC-CV	Castroviejo Needle Holder/Scissors Curved T.C. 150mm
NH-S-C-15-TC-ST	Castroviejo Needle Holder/Scissors Straight T.C. 150mm
NH-S-C-15-TCSC-CV	Castroviejo Needle Holder/Scissors Curved T.C. Supercut 150mm
NH-S-C-15-TCSC-ST	Castroviejo Needle Holder/Scissors Straight T.C. Supercut 150mm

T.C. = Tungsten Carbide.

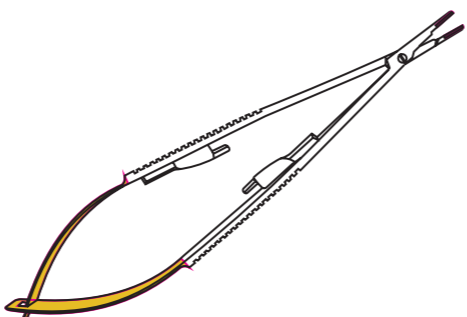
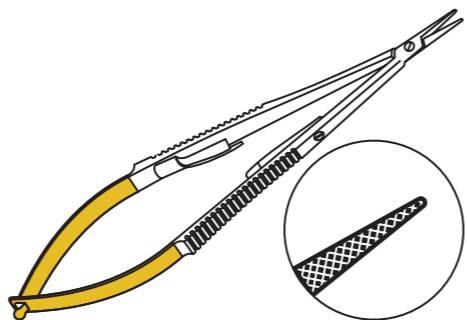
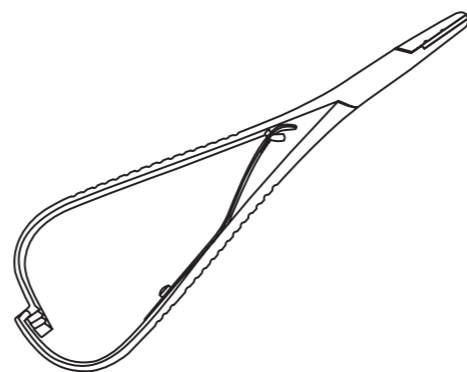

Forceps - Halstead Mosquito

Commonly used haemostat/artery forcep. Also available with a tooth as well as serrated grip.

Order Code	Description
FC-HM-10-CV	Halstead Mosquito 100mm Curved
FC-HM-12-CV	Halstead Mosquito 120mm Curved
FC-HM-T-12-CV	Halstead Mosquito 120mm 1/2 Teeth Curved

Order Code	Description
FC-HM-10-ST	Halstead Mosquito 100mm Straight
FC-HM-12-ST	Halstead Mosquito 120mm Straight
FC-HM-T-12-ST	Halstead Mosquito 120mm 1/2 Teeth Straight

Forceps - Artery

The veterinary standard artery forceps.

Order Code	Description
FC-A-SW-12-CV	Spencer Wells Artery Forceps 120mm Curved
FC-A-SW-15-CV	Spencer Wells Artery Forceps 150mm Curved
FC-A-SW-18-CV	Spencer Wells Artery Forceps 180mm Curved
FC-A-SW-20-CV	Spencer Wells Artery Forceps 200mm Curved

Order Code	Description
FC-A-SW-12-ST	Spencer Wells Artery Forceps 120mm Straight
FC-A-SW-15-ST	Spencer Wells Artery Forceps 150mm Straight
FC-A-SW-18-ST	Spencer Wells Artery Forceps 180mm Straight

Order Code	Description
FC-HM-12-ST-LRA	Halstead Mosquito Forceps 120mm Straight – Long Ratchet

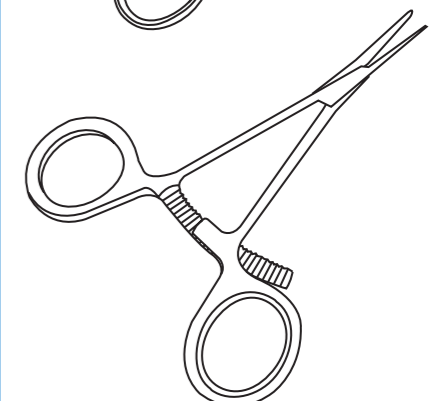
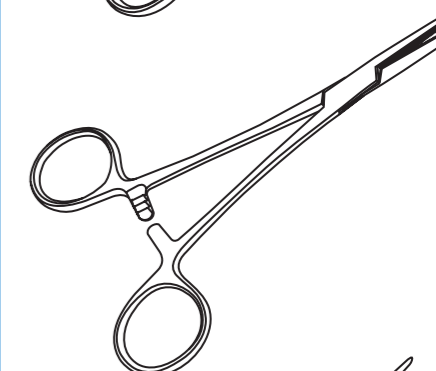
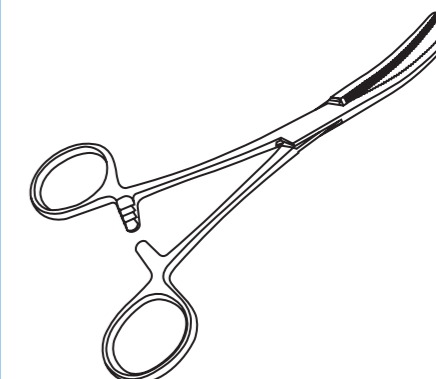
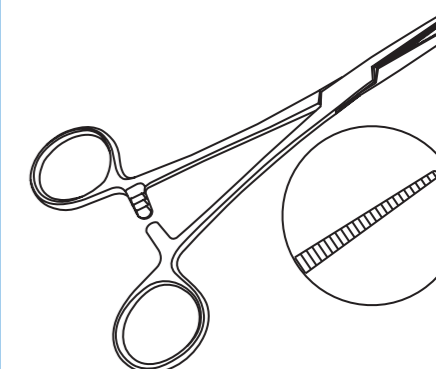
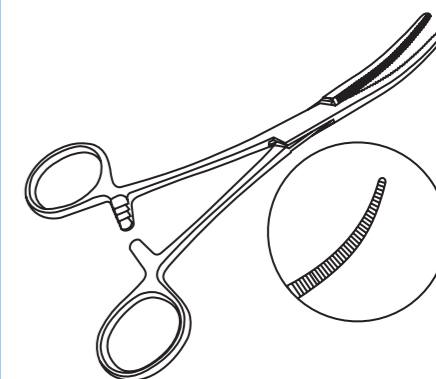

Forceps - Artery

Useful as a hysterectomy clamp as longer jaws than standard Spencer Wells.

Order Code	Description
FC-A-RP-14-CV	Rochester Pean Artery Forceps 140mm Curved
FC-A-RP-16-CV	Rochester Pean Artery Forceps 160mm Curved
FC-A-RP-18-CV	Rochester Pean Artery Forceps 180mm Curved
FC-A-RP-20-CV	Rochester Pean Artery Forceps 200mm Curved

Order Code	Description
FC-A-RP-14-ST	Rochester Pean Artery Forceps 140mm Straight
FC-A-RP-16-ST	Rochester Pean Artery Forceps 160mm Straight
FC-A-RP-18-ST	Rochester Pean Artery Forceps 180mm Straight

Forceps - Dissecting

A selection of rat tooth and serrated tip forceps.

Order Code	Description
FC-DIS-AD-12-S	Adson Dissecting Forceps Serrated 120mm
FC-DIS-AD-12-1/2	Adson Dissecting Forceps 1/2 Teeth 120mm
FC-DIS-AD-15-1/2	Adson Dissecting Forceps 1/2 Teeth 150mm
FC-DIS-ADB-12	Adson-Brown Dissecting Forceps 120mm
FC-DIS-AD-12-1/2S-TC	Adson Dissecting Forceps Serrated and Rat Tooth T.C. Tips 120mm

Order Code	Description
FC-DIS-DB-15	Debakey Dissecting Forceps 150mm
FC-DIS-DB-18	Debakey Dissecting Forceps 180mm

Order Code	Description
FC-DIS-TR-1/2-12	Treves Dissecting Forceps 1/2 Teeth 120mm
FC-DIS-TR-2/3-12	Treves Dissecting Forceps 2/3 Teeth 120mm

Order Code	Description
FC-RT-16	Rat Tooth Forceps Standard 160mm

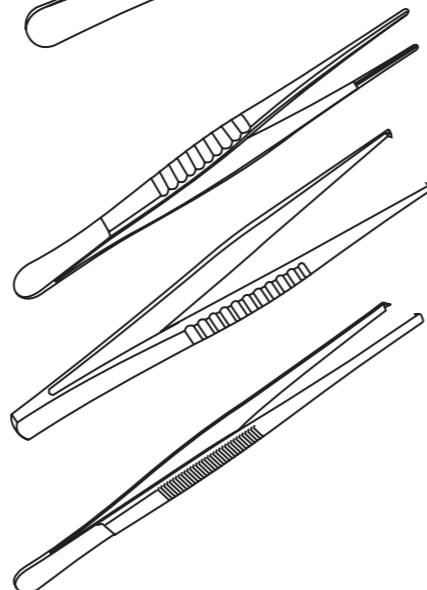
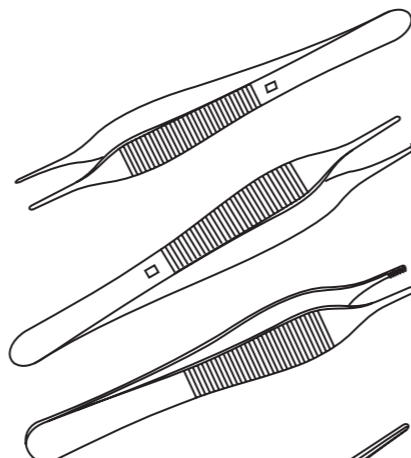
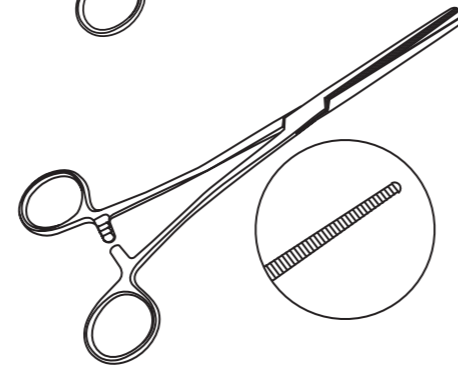
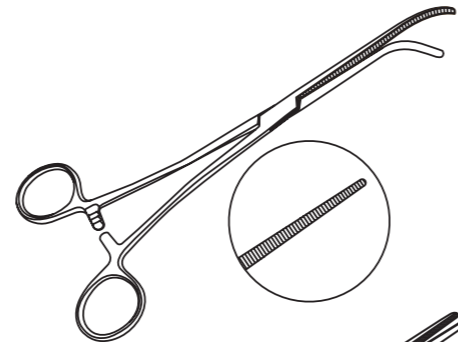

Forceps - Dressing

Simple serrated tips make this useful for holding dressings in place but also useful for other procedures.

Order Code	Description
FC-BE-S-13	Block End Serrated Dressing Forceps 130mm
FC-BE-S-16	Block End Serrated Dressing Forceps 160mm
FC-BE-S-18	Block End Serrated Dressing Forceps 180mm

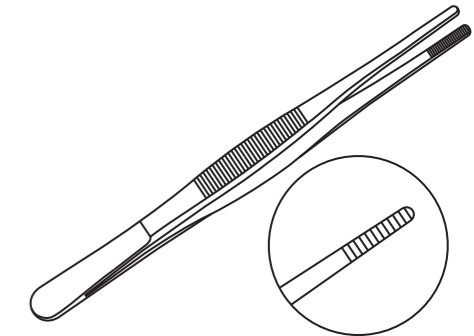

Forceps - Allis Tissue

Tips are curved inwards to provide a secure grip, not recommended for delicate tissue.

Order Code	Description
TF-AL-13-3/4	Allis Tissue Forceps 3/4 Teeth 130mm
TF-AL-15-2/3	Allis Tissue Forceps 2/3 Teeth 150mm
TF-AL-15-3/4	Allis Tissue Forceps 3/4 Teeth 150mm
TF-AL-18-3/4	Allis Tissue Forceps 3/4 Teeth 180mm
TF-AL-230	Allis Tissue Forceps 230mm

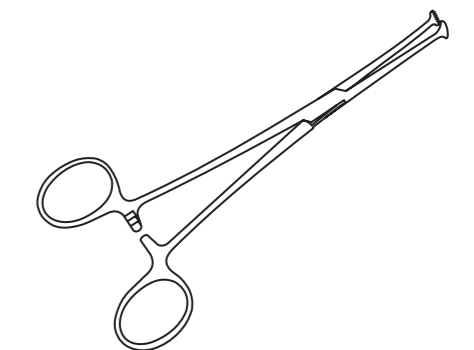

Forceps - Babcock Tissue

Similar to Allis forceps, less traumatic.

Order Code	Description
TF-BAB-160	Babcock Tissue Forceps 160mm
TF-BAB-180	Babcock Tissue Forceps 180mm

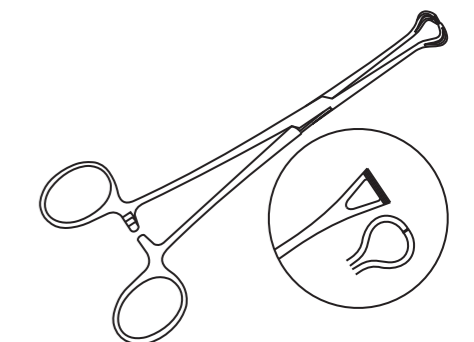

Scissors - Mayo

More heavy duty type scissor.

Standard

Order Code	Description
SC-MCB-14-CV	Mayo Chamfered Blade 140mm Curved
SC-MCB-16-CV	Mayo Chamfered Blade 160mm Curved
SC-MCB-18-CV	Mayo Chamfered Blade 180mm Curved

Order Code	Description
SC-MCB-14-ST	Mayo Chamfered Blade 140mm Straight
SC-MCB-16-ST	Mayo Chamfered Blade 160mm Straight
SC-MCB-18-ST	Mayo Chamfered Blade 180mm Straight

Supercut

Order Code	Description
SC-MCB-14-CV-SC	Mayo Chamfered Blade Supercut 140mm Curved
SC-MCB-16-CV-SC	Mayo Chamfered Blade Supercut 160mm Curved
SC-MCB-18-CV-SC	Mayo Chamfered Blade Supercut 180mm Curved

Order Code	Description
SC-MCB-14-ST-SC	Mayo Chamfered Blade Supercut 140mm Straight
SC-MCB-16-ST-SC	Mayo Chamfered Blade Supercut 160mm Straight
SC-MCB-18-ST-SC	Mayo Chamfered Blade Supercut 180mm Straight

Supercut T.C.

Order Code	Description
SC-MCB-14-CV-SCTC	Mayo Chamfered Blade Supercut T.C. 140mm Curved
SC-MCB-16-CV-SCTC	Mayo Chamfered Blade Supercut T.C. 160mm Curved
SC-MCB-18-CV-SCTC	Mayo Chamfered Blade Supercut T.C. 180mm Curved

Order Code	Description
SC-MCB-14-ST-SCTC	Mayo Chamfered Blade Supercut T.C. 140mm Straight
SC-MCB-16-ST-SCTC	Mayo Chamfered Blade Supercut T.C. 160mm Straight
SC-MCB-18-ST-SCTC	Mayo Chamfered Blade Supercut T.C. 180mm Straight

T.C. = Tungsten Carbide.

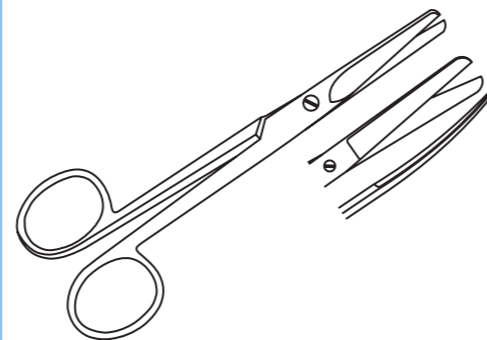

Scissors - Metzenbaum

Finer and more slender than Mayo scissors, often used for more delicate procedures.

Standard

Order Code	Description
SC-MZ-12-CV	Metzenbaum Scissors 120mm Curved
SC-MZ-14-CV	Metzenbaum Scissors 140mm Curved
SC-MZ-16-CV	Metzenbaum Scissors 160mm Curved
SC-MZ-18-CV	Metzenbaum Scissors 180mm Curved

Order Code	Description
SC-MZ-12-ST	Metzenbaum Scissors 120mm Straight
SC-MZ-14-ST	Metzenbaum Scissors 140mm Straight
SC-MZ-16-ST	Metzenbaum Scissors 160mm Straight
SC-MZ-18-ST	Metzenbaum Scissors 180mm Straight

Supercut

Order Code	Description
SC-MZ-14-CV-SC	Metzenbaum Scissors Supercut 140mm Curved
SC-MZ-16-CV-SC	Metzenbaum Scissors Supercut 160mm Curved
SC-MZ-18-CV-SC	Metzenbaum Scissors Supercut 180mm Curved

Order Code	Description
SC-MZ-14-ST-SC	Metzenbaum Scissors Supercut. 140mm Straight
SC-MZ-16-ST-SC	Metzenbaum Scissors Supercut. 160mm Straight
SC-MZ-18-ST-SC	Metzenbaum Scissors Supercut. 180mm Straight

Supercut T.C.

Order Code	Description
SC-MZ-14-CV-SCTC	Metzenbaum Scissors S.T.C. 140mm Curved
SC-MZ-16-CV-SCTC	Metzenbaum Scissors S.T.C. 160mm Curved
SC-MZ-18-CV-SCTC	Metzenbaum Scissors S.T.C. 180mm Curved
SC-MZ-20-CV-SCTC	Metzenbaum Scissors S.T.C. 200mm Curved

Order Code	Description
SC-MZ-14-ST-SCTC	Metzenbaum Scissors S.T.C. 140mm Straight
SC-MZ-16-ST-SCTC	Metzenbaum Scissors S.T.C. 160mm Straight
SC-MZ-18-ST-SCTC	Metzenbaum Scissors S.T.C. 180mm Straight

T.C.

Order Code	Description
SC-MZ-23-ST-TC	Metzenbaum Scissors T.C. 235mm Straight

T.C. = Tungsten Carbide. S.T.C. = Supercut Tungsten Carbide.

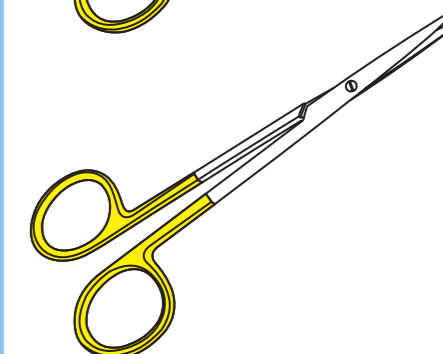
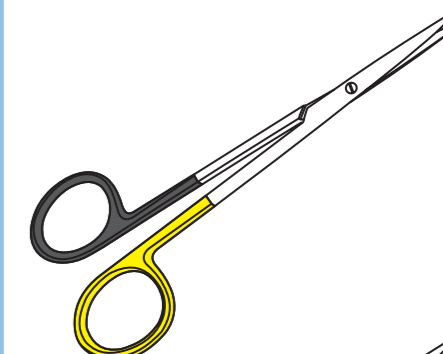
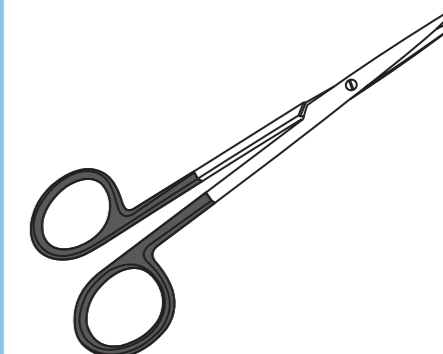
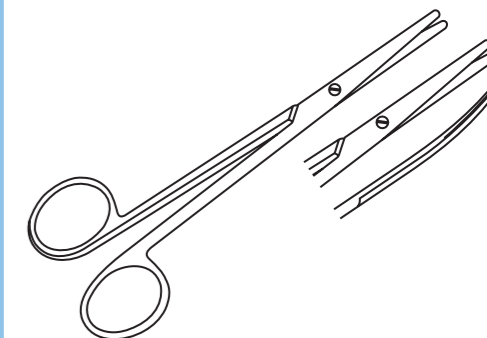

Scissors - Dressing

Non surgical scissor favoured by nurses. N2's dressing scissors are blunt/blunt meaning the end of both tips are rounded to prevent unwanted damage. We can also get in blunt/sharp and sharp/sharp options.

Order Code	Description
SC-DR-BB-9-CV	Dressing Scissors Blunt/Blunt 90mm Curved
SC-DR-BB-12-CV	Dressing Scissors Blunt/Blunt 120mm Curved
SC-DR-BB-15-CV	Dressing Scissors Blunt/Blunt 150mm Curved
SC-DR-BB-18-CV	Dressing Scissors Blunt/Blunt 180mm Curved

Order Code	Description
SC-DR-BB-9-ST	Dressing Scissors Blunt/Blunt 90mm Straight
SC-DR-BB-12-ST	Dressing Scissors Blunt/Blunt 120mm Straight
SC-DR-BB-15-ST	Dressing Scissors Blunt/Blunt 150mm Straight
SC-DR-BB-18-ST	Dressing Scissors Blunt/Blunt 180mm Straight

Order Code	Description
SC-DR-SS-12-CV	Dressing Scissors Sharp/Sharp 120mm Curved

Order Code	Description
SC-OS-14-ST-SS-TC	Operating Scissors Sharp/Sharp T.C. 145mm Straight

Scissors - Bandage

Similar design to standard scissors but bottom blade has a round disc to prevent damage to tissues under the bandage.

Order Code	Description
SC-BAN-L-14	Lister Bandage Scissors 140mm
SC-BAN-L-16	Lister Bandage Scissors 160mm

Scissors - Coloured

We have launched a few scissors in coloured options to help identify them and their owners. Others are available on request.

Order Code	Description
SC-DR-BB-12-CV-BLK	Dressing Scissors 120mm Curved Black
SC-DR-BB-12-CV-BL	Dressing Scissors 120mm Curved Blue
SC-DR-BB-12-CV-GD	Dressing Scissors 120mm Curved Gold
SC-DR-BB-12-CV-RB	Dressing Scissors Blunt/Blunt 120mm Curved Rainbow
SC-DR-BB-15-CV-R	Dressing Scissors Blunt/Blunt 150mm Curved Rainbow

Order Code	Description
SC-MZ-14-ST-BLK	Metzenbaum Scissors 140mm Straight Black
SC-MZ-14-ST-BL	Metzenbaum Scissors 140mm Straight Blue
SC-MZ-14-ST-GD	Metzenbaum Scissors 140mm Straight Gold
SC-MZ-14-ST-RB	Metzenbaum Scissors 140mm Straight Rainbow

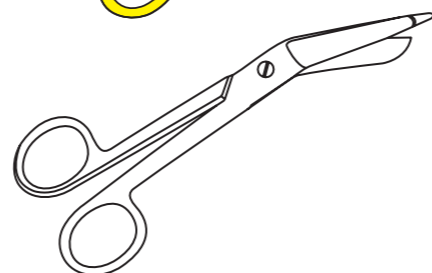
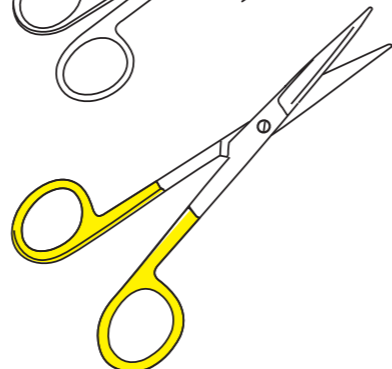
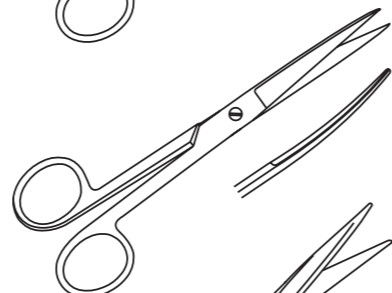
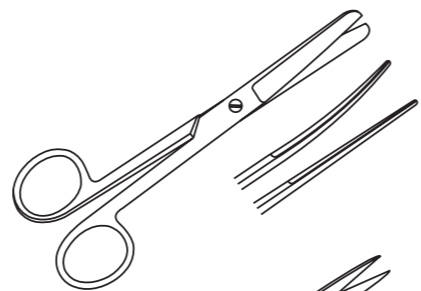

Retractor - Gelpi

N2 carry 3 types of Gelpi retractor; curved, curved long reach, and straight long reach.

Straight: refers to the shaft being straight and in-line with the handles.

Curved: is where the shaft is curved so the tips are lower than the handles.

Long Reach: refers to the tips are angled downwards so they sit much lower in the incision.

Curved Long Reach

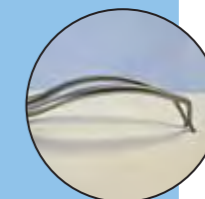

Straight Long Reach



Curved



Order Code	Description
RT-GP-90-ST-SLR	Gelpi Mini 45mm Spread Straight 90mm Flat Tips

Order Code	Description
RT-GP-90-CV	Gelpi Mini 45mm Spread Curved 90mm Sharp Tip
RT-GP-135-CV	Gelpi 60mm Spread Curved 135mm
RT-GP-180-CV	Gelpi 120mm Spread Curved 180mm

Order Code	Description
RT-GP-135-SLR	Gelpi 70mm Spread Straight Long Reach 135mm Long Reach=20mm
RT-GP-180-CLR	Gelpi 120mm Spread Curved Long Reach 180mm LR=30mm
RT-GP-180-SLR	Gelpi 120mm Spread Straight Long Reach 180mm LR=25mm
RT-GP-180-CXLR	Gelpi Extra Long Reach Retractor 180mm LR=60mm
RT-GP-180-CXLR-S	Gelpi Extra Long Reach Retractor 180mm LR=60mm - Sharp Tip

LR = Long Reach.

Supplied as a pair with opposing tips on each pair being extended to retract deeper into the incision area.

Order Code	Description
RT-GP-OL-13	Gelpi Odd Leg (Pair) 130mm
RT-GP-OL-20	Gelpi Odd Leg (Pair) 200mm

Apart from the 90mm Gelpi all the rest are blunt tipped as standard as this is less atraumatic. We can supply sharp tipped Gelpis on request. Please allow longer for delivery on these items.

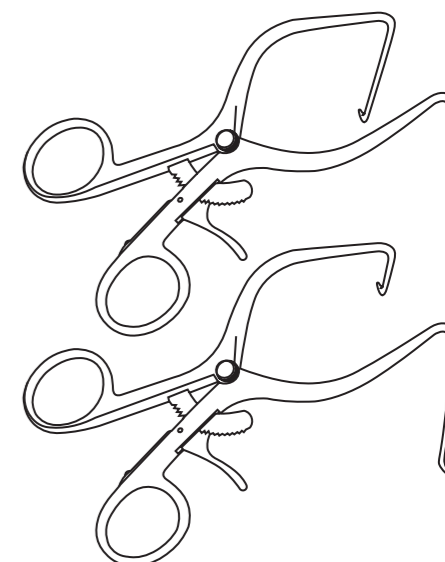
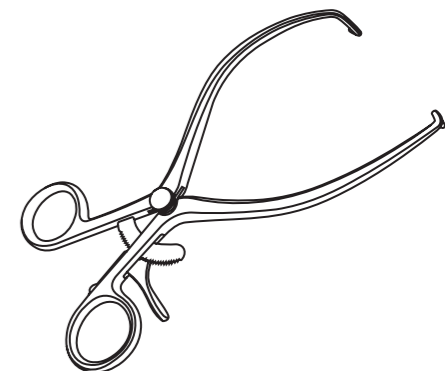
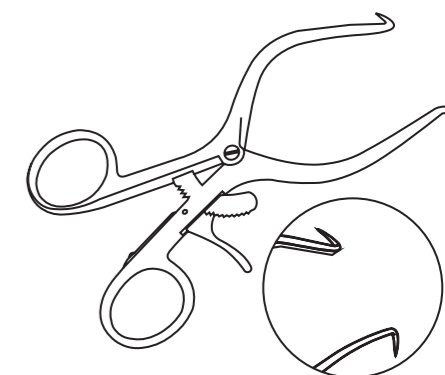

Bowel Clamps and Angiotribes

Large haemostat type forceps commonly used in spays. For spay kits see page 83.

Order Code	Description
AN-20-CV	Angiotribe 200mm Curved
AN-20-ST	Angiotribe 200mm Straight

Designed to be less traumatic.

Order Code	Description
BC-AT-17-CV	Atraumatic Clamp 170mm Curved
BC-AT-17-ST	Atraumatic Clamp 170mm Straight

Serrations run down the length of the tip.

Order Code	Description
BC-D-24-CV	Doyen Bowel Clamp 240mm Curved
BC-D-24-ST	Doyen Bowel Clamp 240mm Straight

The jaws have an atraumatic grip to hold the very slippery soft palate. Also useful for vascular clamps.

Order Code	Description
CL-SP-SM-170	Soft Palate Clamp 18 x 7 170mm Long
CL-SP-LG-170	Soft Palate Clamp 26 x 12 170mm Long

Tip is bent at 90 degrees for extra grip.

Order Code	Description
CL-RA-19	Right Angled Clamps 195mm

Forceps - Carmalt

Carmalt forceps have multiple groves on the jaws.

Order Code	Description
FC-CM-16-CV	Carmalt Forceps 160mm Curved
FC-CM-16-ST	Carmalt Forceps 160mm Straight
FC-CM-20-CV	Carmalt Forceps 200mm Curved
FC-CM-20-ST	Carmalt Forceps 200mm Straight

Endotracheal Tube Holder

Made in stainless steel and wall mountable, we offer two sizes that store either 7 or 16 tubes horizontally.

Order Code	Description
ET-HOLD-30	ET Tube Holder for Wall 280mm - 7 Tubes
ET-HOLD-60	ET Tube Holder for Wall 600mm - 16 Tubes

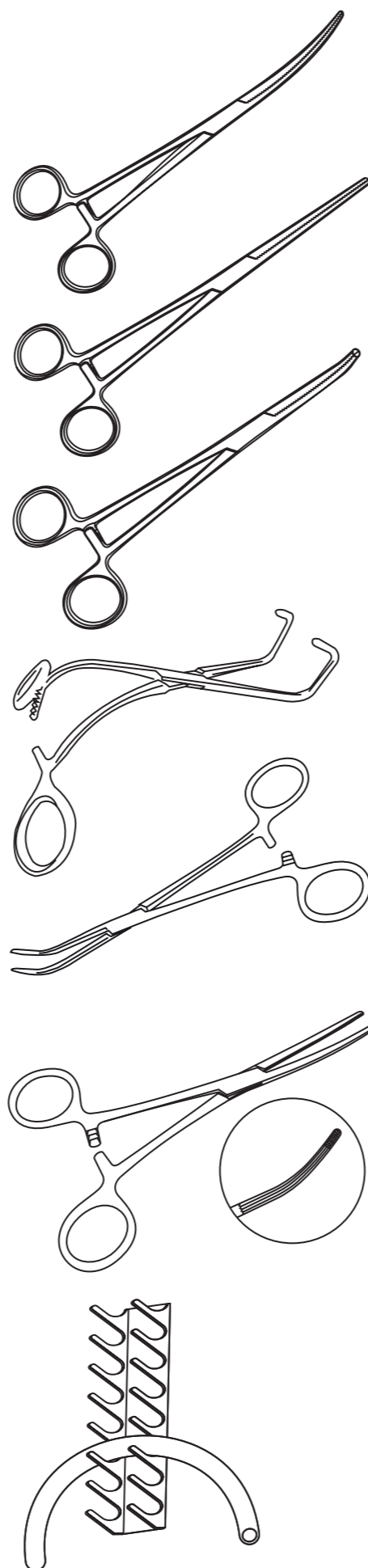

Tonsillectomy Clamp

Used primarily in tonsillectomy and can also be used as a large artery forcep.

Order Code	Description
CL-T-CV-20	Tonsillectomy Clamp Curved 200mm
CL-T-RA-16	Tonsillectomy Clamp Right Angled 160mm
CL-T-RA-20	Tonsillectomy Clamp Right Angled 200mm
CL-T-RA-23	Tonsillectomy Clamp Right Angled 230mm

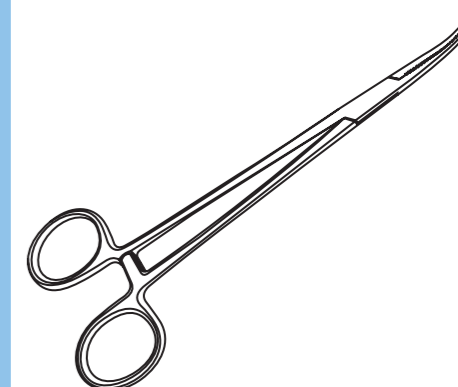

Forceps - Grasping

For grasping small items that are lodged such as grass seeds in ear canals. The fine tip version offers a very small end for more delicate areas. We also offer a flexible version which is particularly useful when used with an otoscope speculum.

Order Code	Description
FC-G-12	120mm Length Grasping Forceps
FC-G-17	170mm Length Grasping Forceps
FC-G-22	220mm Length Grasping Forceps
FC-G-12-FINE	120mm Length Grasping Forceps Fine Tip
FC-G-17-FINE	170mm Length Grasping Forceps Fine Tip
FC-G-22-FINE	220mm Length Grasping Forceps Fine Tip

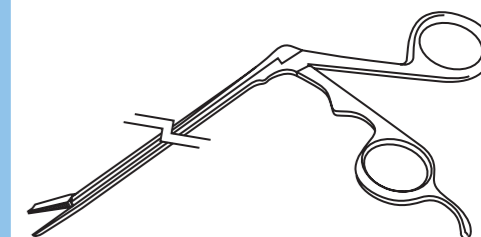

Arthroscopic Grasping Forceps

Extremely useful for hard to reach areas such as with a Speculae.

Order Code	Description
FC-G-17-FLEX	170mm Length Grasping Forceps Flexible

Order Code	Description
FC-AG-A-20-12	Arthroscopic Grasping Forcep Alligator Tip 2.0mm - 120mm Long
FC-AG-A-27-12	Arthroscopic Grasping Forcep Alligator Tip 2.7mm - 120mm Long
FC-AG-H-27-12	Arthroscopic Grasping Forcep Hooked Tip 2.7mm - 120mm Long

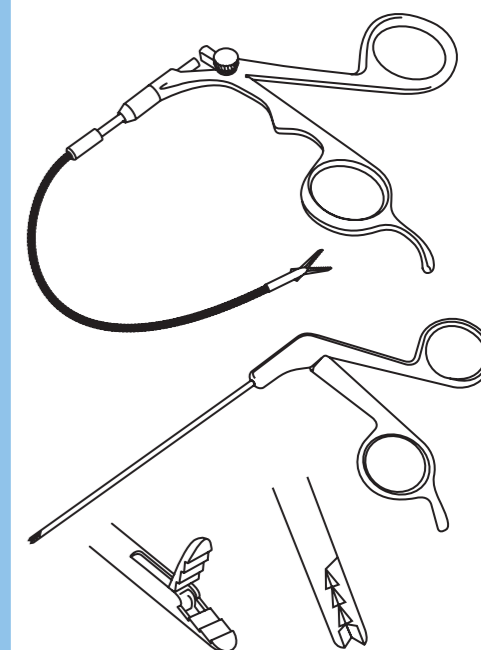

Scalpel Handles and Blades

The Beaver blade is ideal for fine work such as ophthalmic surgery. Our standard no 3 blade comes with a scale on the handle and the end of the handle has a slight sharpness making it useful for stripping muscle from bone.

Scalpel Handles

Order Code	Description
BB-H	Blade Handle Beaver Type 130mm
SH-03	Scalpel Handle no3 with Scale 125mm
SH-04	Scalpel Handle no4 with Scale 125mm
SH-07	Scalpel Handle no7 with Scale 125mm

Scalpel Blades

Features of the blades

- Designed for tissue cutting and puncturing
- Carbon steel material for exacting performance
- Special edge treatment reduces drag and tissue trauma
- Provide consistent sharpness – right out of the box
- Fits all makes of handles – conforms to ISO 7740

Packaging

- Gamma sterilized
- Individually packaged in easy-peel colour-coded foil, for maximum safety wrapped in aluminium V.C.I. paper



For blade handle Number 3

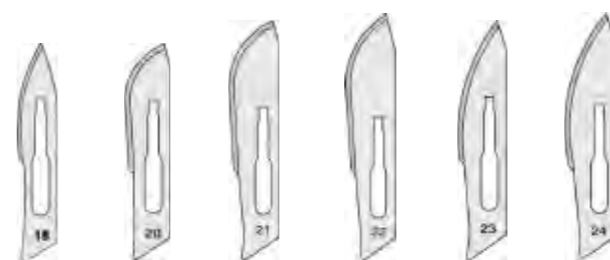

For blade handle Number 4

Order Code	Description (Packs of 100)
SB-03-10	Scalpel Blade No.10 for Number 3 Handle
SB-03-11	Scalpel Blade No.11 for Number 3 Handle
SB-03-12	Scalpel Blade No.12 for Number 3 Handle
SB-03-15	Scalpel Blade No.15 for Number 3 Handle
SB-04-18	Scalpel Blade No.18 for Number 4 Handle
SB-04-20	Scalpel Blade No.20 for Number 4 Handle
SB-04-21	Scalpel Blade No.21 for Number 4 Handle
SB-04-22	Scalpel Blade No.22 for Number 4 Handle
SB-04-23	Scalpel Blade No.23 for Number 4 Handle
SB-04-24	Scalpel Blade No.24 for Number 4 Handle

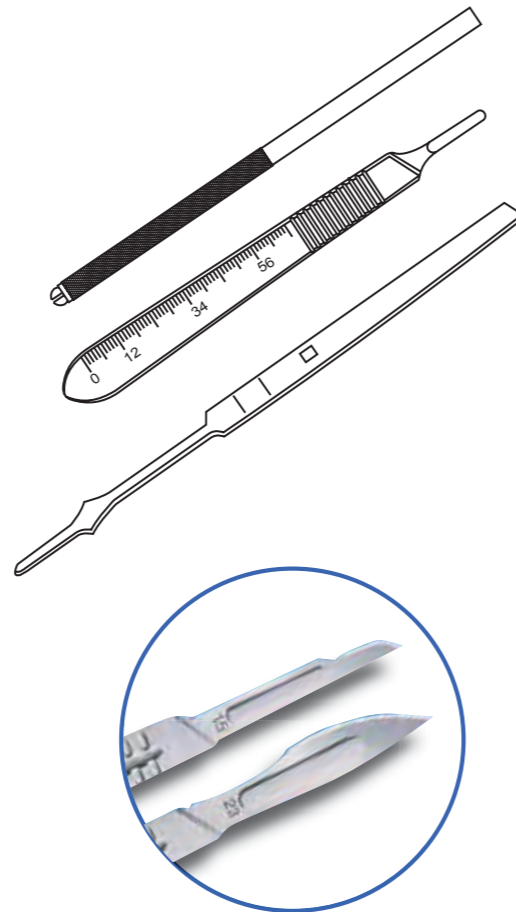

Spay Instruments

N2 has prepared 2 kits containing the most commonly used instruments; please feel free to contact us to discuss any bespoke kit needs.

Order Code	Description
CS-KIT	Canine Spay Kit - Complete in Box
Each kit comprises:	Spencer Wells Artery Forceps Straight and Curved 120mm, Spencer Wells Artery Forceps Curved 150mm, Carmault Forceps Curved 160mm and 200mm, Spay Forceps, Mayo Scissors Straight and Curved 140mm, Allis Tissue Forceps 150mm 3/4 Teeth x 2, Olsen Hegar Needle Holders T.C. 140mm, Rat Tooth Forceps 140mm, Towel Clips Jones 90mm x 4, Scalpel Handle, Sterilisable Box.
FS-KIT	Feline Spay Kit - Complete in Box
Each kit comprises:	Spencer Wells Artery Forceps Curved 120mm x 2, Dissecting Forceps Adson 1/2 Teeth 120mm, Halstead Mosquito Forceps 120mm x 2, Metzenbaum Scissors Straight 140mm, Olsen Hegar Needle Holders T.C. 140mm, Spay Forceps 120mm, Towel Clips Jones 90mm x 4, Scalpel Handle, Sterilisable Box.

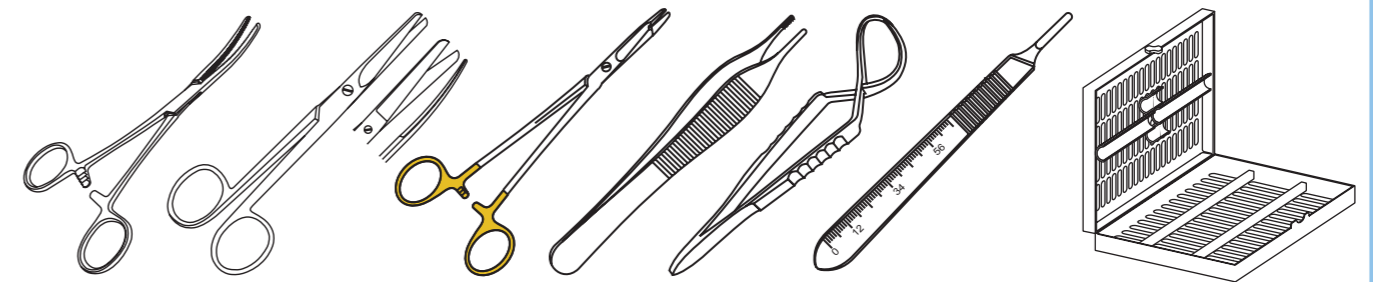

Blunt ended instruments used primarily to lift uterine horns whilst causing minimal trauma.

Order Code	Description
SH-13	Spay Hook Small 130mm
SH-17	Spay Hook Large 170mm

Fine tipped forceps with serrated ends.

Order Code	Description
FC-SPAY-12	Spay Forceps 120mm

Very narrow tipped forceps ideal for spay procedures. The Debaquey type has a more atraumatic grip.

Order Code	Description
SF-D-12	Spay Forceps - Debaquey 120mm

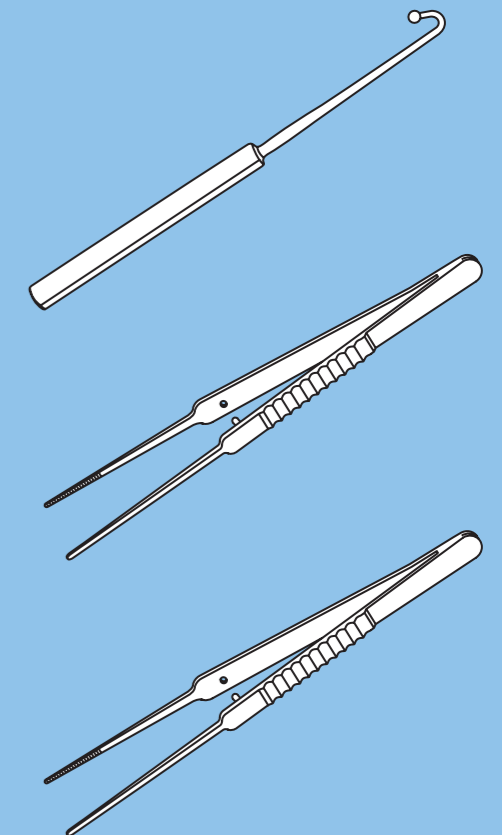

For full terms and conditions please visit our website.

Towel Clamps

Standard selection of clamps used in everyday practice.

Order Code	Description
TC-BT-9	Backhaus Towel Clip 90mm
TC-BT-11	Backhaus Towel Clip 110mm

Blunt Tips Ensure Atraumatic Fixation.

Order Code	Description
TC-AT-11	Atraumatic Towel Clip 110mm

Basic towel clip that locks when pressure is released.

Order Code	Description
TC-SCA-90	Shardel Cross Action 90mm

As above but with knurling on handle.

Order Code	Description
TC-JCA-90	Jones Cross Action 90mm

Excellent for fastening drapes together. Design causes less damage to material.

Order Code	Description
TC-CL-BS	Ball & Socket Towel Clip

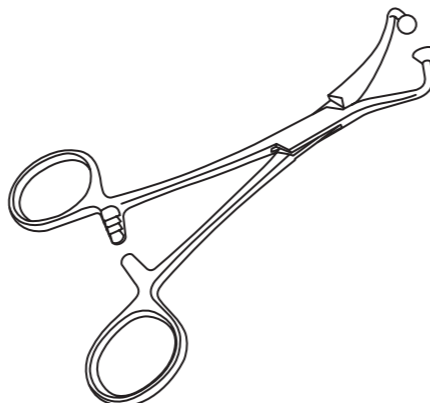
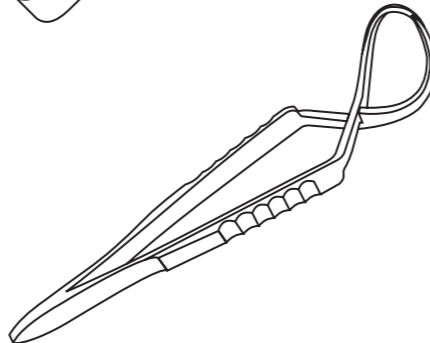
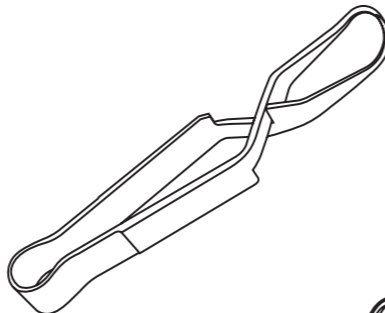
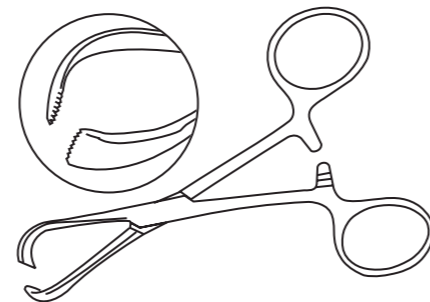
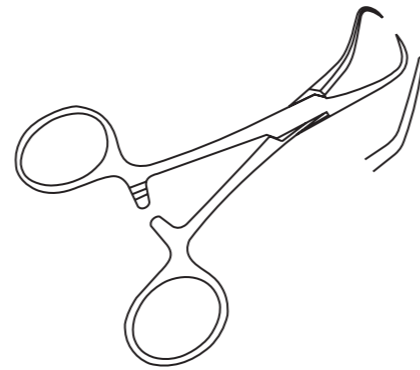

Wound Stapler

The single use stapler comes sterile and preloaded with 35 staples. The clear display shows the user how many staples are left.

Order Code	Description
SS-STAP-35	Single Use Stapler with 35 Preloaded Staples
SS-REM	Stainless Steel Staple Remover

Staple Size 6.4 x 4.0mm

Benefits:

- Ergonomic and user friendly design
- Clear view of operating site
- Easy to check remaining staples

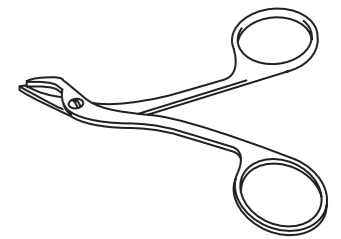
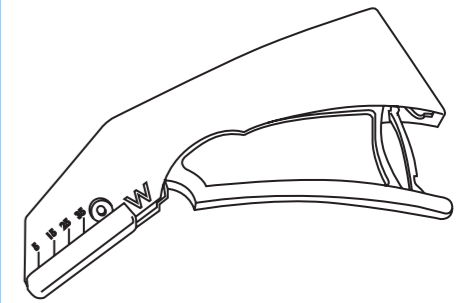

Left-Handed Instruments

15% of the worlds population are left-handed with twice as many men than woman.

Sometimes in the veterinary market these 15% are overlooked or taken advantage of with a premium being placed on dedicated left-handed instrument costs to the 'more regular' right-handed instruments.

At N2 we have launched a range of left-handed Instruments that are useful every day. The handles are matt instead of polished for easy identification.

Our range is much bigger than listed so if we don't show it please ask and we can most probably source it for you.

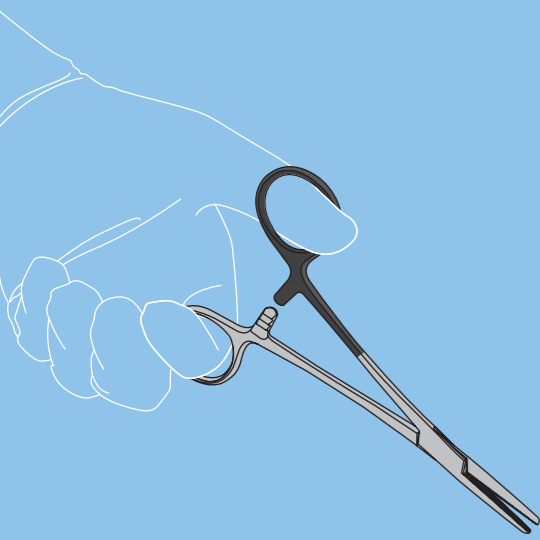

Scissors

Order Code	Description
SC-MCB-14-ST-LH	Mayo Scissors 140mm Straight
SC-MCB-16-ST-LH	Mayo Scissors 160mm Straight

Order Code	Description
SC-MCB-14-CV-LH	Mayo Scissors 140mm Curved
SC-MCB-16-CV-LH	Mayo Scissors 160mm Curved

Order Code	Description
SC-MZ-14-ST-LH	Metzenbaum Scissors 140mm Straight
SC-MZ-14-CV-LH	Metzenbaum Scissors 140mm Curved
SC-MZ-18-ST-LH	Metzenbaum Scissors 180mm Straight

Order Code	Description
SC-BAN-L-14-LH	Lister Bandage Scissors 140mm
SC-IS-11-ST-LH	Iris Scissors Straight 110mm
SC-IS-11-CV-LH	Iris Scissors Curved 110mm

Forceps

Order Code	Description
FC-HM-12-ST-LH	Halstead Mosquito Forceps 120mm Straight
FC-HM-12-CV-LH	Halstead Mosquito Forceps 120mm Curved
FC-A-CR-14-ST-LH	Crile Artery Forceps 140mm Straight
FC-A-CR-14-CV-LH	Crile Artery Forceps 140mm Curved

Order Code	Description
FC-A-RP-16-ST-LH	Rochester Pean Artery Forceps 160mm Straight
FC-A-RP-16-CV-LH	Rochester Pean Artery Forceps 160mm Curved

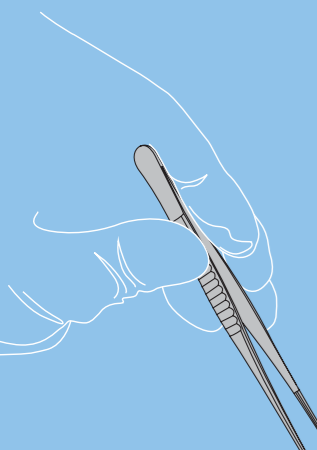

Left-Handed Instruments cont.

Needle Holders

Order Code	Description
NH-OH-14-LH	Olsen Hegar Needle Holders 140mm
NH-OH-16-LH	Olsen Hegar Needle Holders 160mm

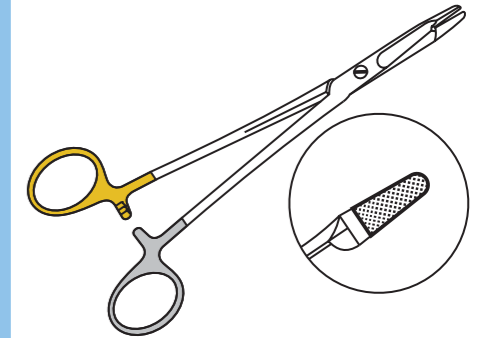

Order Code	Description
NH-GL-12-TC-LH	Gillies Needle Holders T.C. 125mm
NH-GL-14-LH	Gillies Needle Holders 140mm
NH-GL-14-TC-LH	Gillies Needle Holders T.C. 140mm

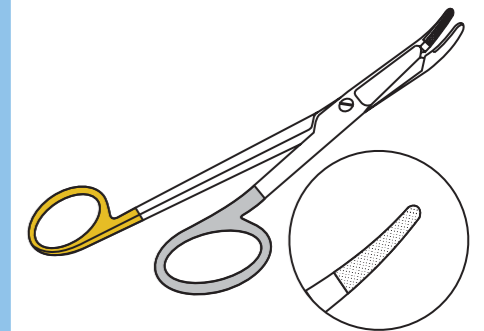

Order Code	Description
NH-MH-16-LH	Mayo Hegar Needle Holders 160mm
NH-MH-18-LH	Mayo Hegar Needle Holders 180mm

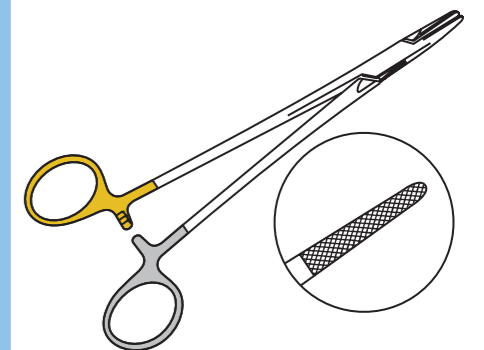

T.C. = Tungsten Carbide.

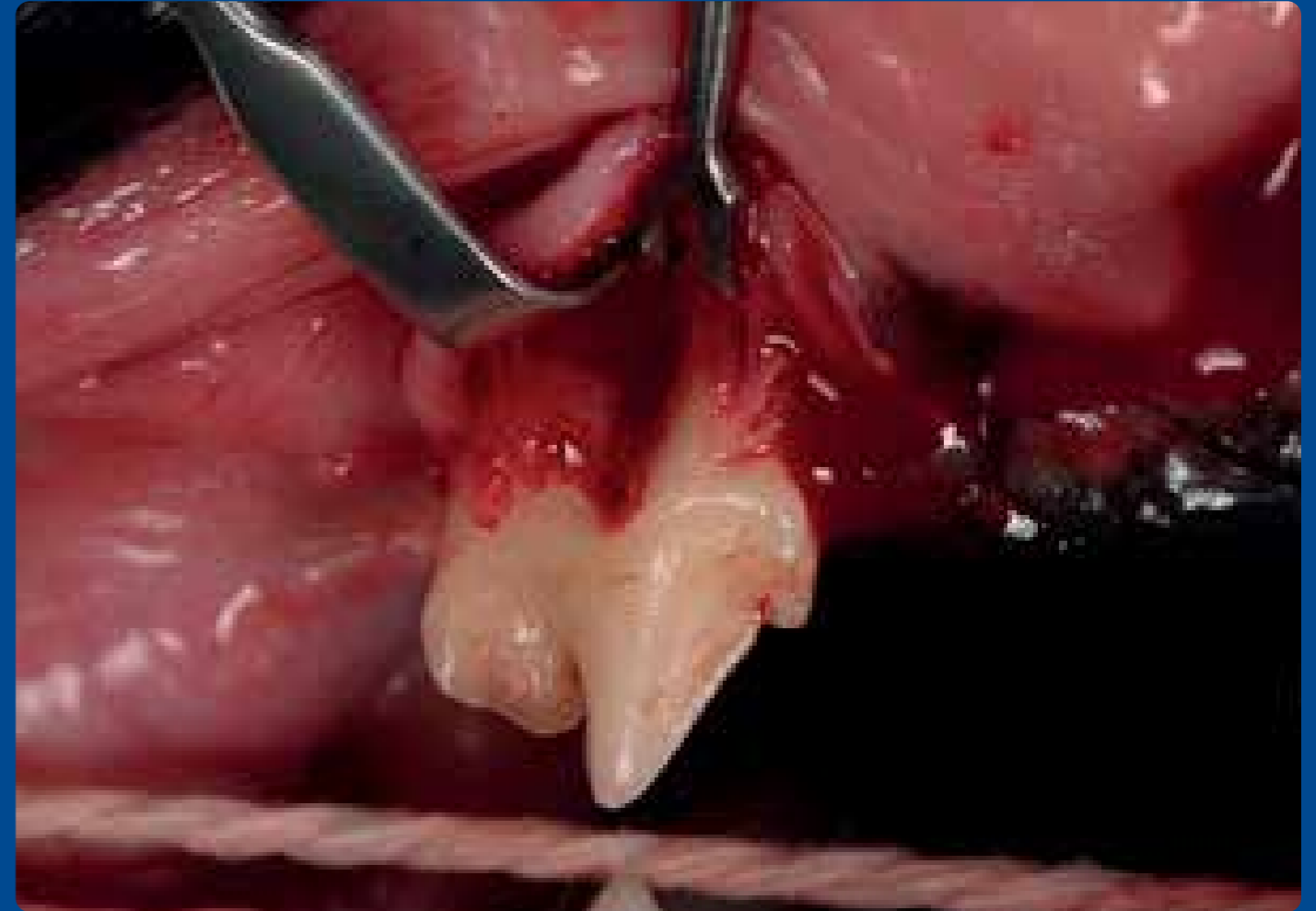

Image courtesy of Bob Partridge

BVM&S Dipl. EVDC MRCVS

Recognised Specialist in Veterinary Dentistry

Mouth Gags Grays

Well known mouth gags used for any dental procedure. Has plastic tips on the ends to protect patients teeth, spring loaded mechanism allows perfect sizing. Please ensure you remove these regularly during prolonged procedures to ensure patients comfort and protect against damage to the jaw.

Order Code	Description
GMG-6	Grays Mouth Gag 60mm Gape
GMG-9	Grays Mouth Gag 90mm Gape
GMG-11	Grays Mouth Gag 110mm Gape
GMG-14	Grays Mouth Gag 140mm Gape

Explorer Probe

Designed to inspect the health of animal's teeth and surrounding gums, a very useful instrument.

Order Code	Description
PR-EXP-170	Measuring/Explorer Probe 170mm

Curette

Used predominantly to remove tartar from the gum line.

Order Code	Description
CU-SUPG-16	Supragingival Curette Double Ended 165mm
CU-SUPG-17	Supragingival Curette Double Ended 170mm

Sickle Scaler

Heavier outbreaks of tartar can be removed with the thicker tips on the Sickle Scaler.

Order Code	Description
SI-SC-170	Sickle Scaler 170mm

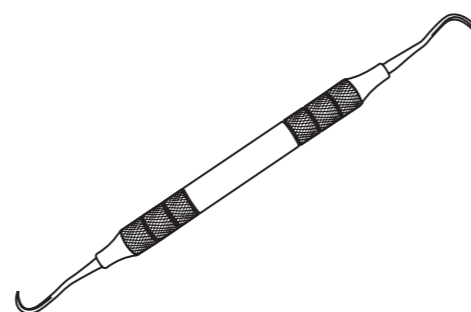
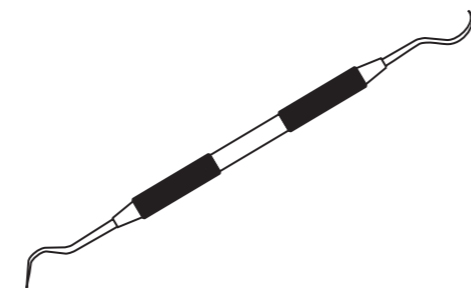
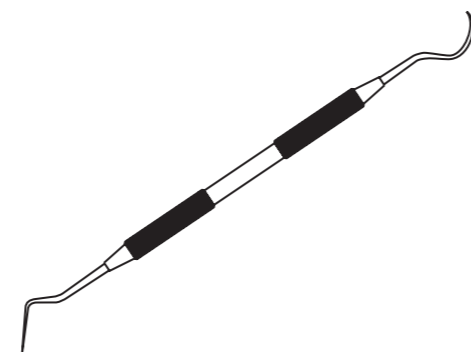
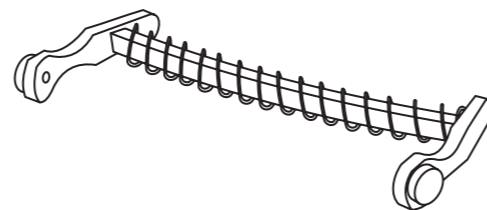

Elevators Carnivore

An economic range of straight elevators.

Order Code	Description
CE-25-14	Carnivore Elevator No.1 2.5mm
CE-35-14	Carnivore Elevator No.2 3.5mm
CE-45-14	Carnivore Elevator No.3 4.5mm

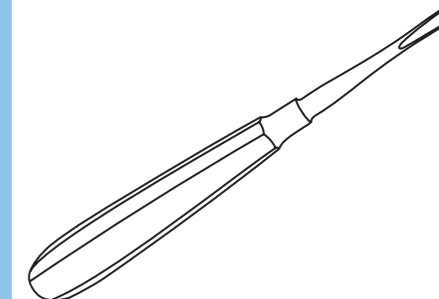

Elevators Winged

Elevators are used to lift teeth from the gum using healthy adjacent teeth. Stronger shafts allow lifting pressure to be exerted unlike the luxators.

Veterinary standard winged elevators in 1mm-4mm sizes, N2 elevators are winged to improve how it shapes around the root.

Order Code	Description
WE-1	1mm Winged Elevator Metal Handle
WE-2	2mm Winged Elevator Metal Handle
WE-3	3mm Winged Elevator Metal Handle
WE-4	4mm Winged Elevator Metal Handle

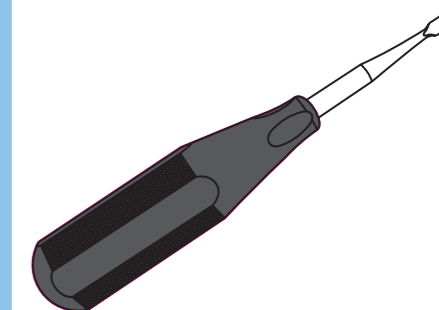

Set is supplied in a fully autoclavable stainless steel box.

Order Code	Description
WE-SET	Complete Winged Elevator Set in Case (Coloured Handle)

Same principle as standard winged elevators but comes instead with a short handle to fit in smaller hands and to maximise the surgeons' control.

Order Code	Description
WE-SH-1	1mm Short Handled Winged Elevator
WE-SH-2	2mm Short Handled Winged Elevator
WE-SH-3	3mm Short Handled Winged Elevator
WE-SH-4	4mm Short Handled Winged Elevator
WE-SH-5	5mm Short Handled Winged Elevator
WE-SH-6	6mm Short Handled Winged Elevator

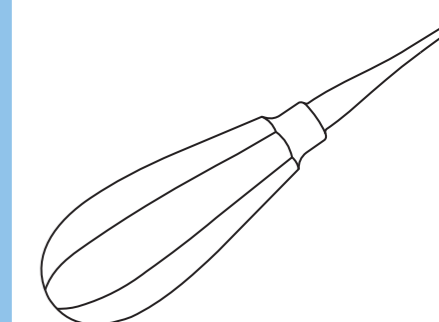

Order Code	Description
WE-SH-SET-4	Set of 4 Short Handled Winged Elevators in Case
WE-SH-SET-6	Set of 6 Short Handled Winged Elevators in Case

Luxation Instruments

The standard basic luxation instrument in both standard and short handles.

Order Code	Description
LX-1-ST	Luxation Instrument Straight 1mm
LX-2-ST	Luxation Instrument Straight 2mm
LX-3-ST	Luxation Instrument Straight 3mm
LX-4-ST	Luxation Instrument Straight 4mm
LX-SET	Complete Luxation Instrument Set in Case

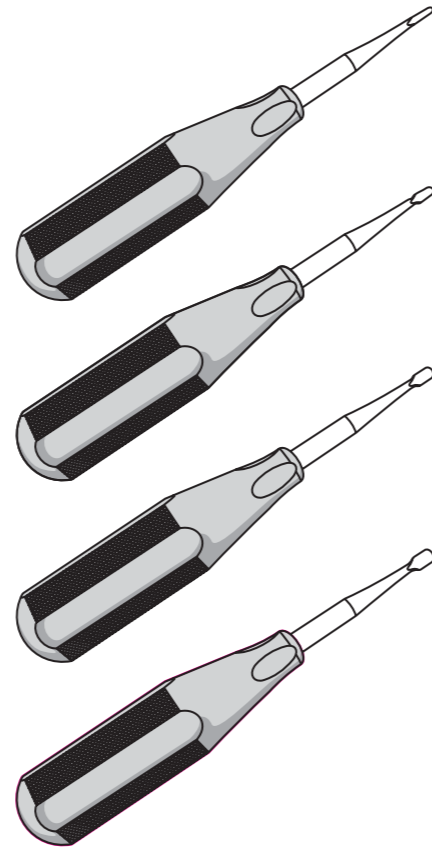

Order Code	Description
LX-SH-1-ST	Luxation Instrument Straight 1mm Short Handle
LX-SH-2-ST	Luxation Instrument Straight 2mm Short Handle
LX-SH-3-ST	Luxation Instrument Straight 3mm Short Handle
LX-SH-4-ST	Luxation Instrument Straight 4mm Short Handle
LX-SH-SET	Complete Luxation Instrument Set Short Handle in Case

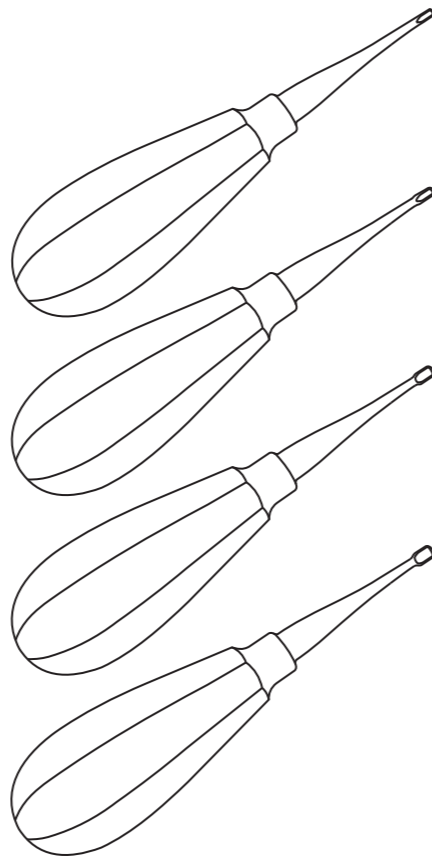

Periosteal Elevators

A range of useful periosteal elevators used for both separating the tooth from the periosteum and also accessing retained roots.

Order Code	Description
PE-2/3-18	Periosteal Elevator 2/3mm 180mm
PE-4/7-20	Periosteal Elevator 4/7mm 200mm
PE-F-5-18	Freer Periosteal Elevator 5mm, 180mm
PE-5-18-CV	Periosteal Elevator 5mm Curved Tip 180mm
PE-5-18-SQ	Periosteal Elevator 5mm Square Tip 180mm
PE-6-18-CV	Periosteal Elevator 6mm Curved Tip 180mm
PE-6-18-SQ	Periosteal Elevator 6mm Square Tip 180mm

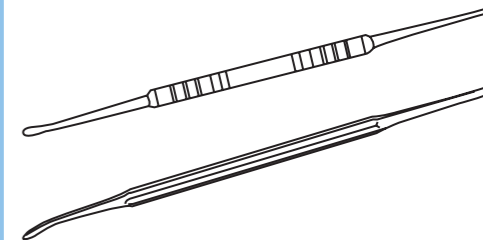
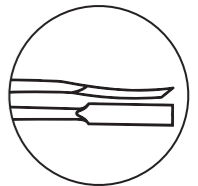
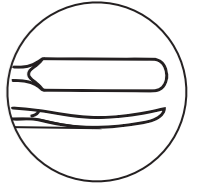
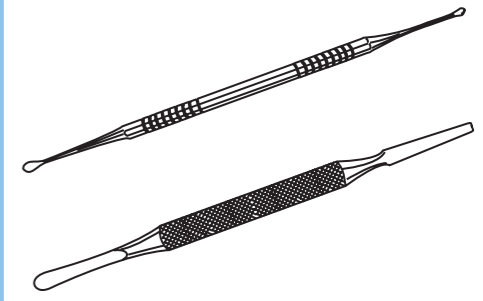

Molt

Order Code	Description
PE-M-2.5/4.5-20	Molt Periosteal Elevator 2.5/4.5mm 205mm
PE-MOLT	Modified Molt Periosteal Elevator

Freer

Order Code	Description
PE-FREER	Modified Freer Periosteal Elevator

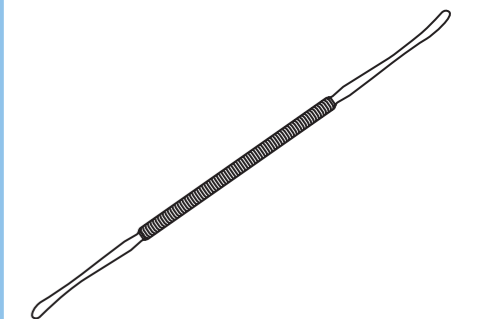

Forceps

A selection of dental forceps designed to loosen/remove deposits of tartar that have built up. A selection of tips and sizes are available for all patients.

Order Code	Description
FC-TSL-13	Tartar Forcep Spring Loaded 130mm

Order Code	Description
FC-TSL-CV-S-12	Small Tartar Forceps Curved Upper Jaw Spring Loaded 120mm
FC-TSL-CV-L-16	Large Tartar Forceps Curved Upper Jaw Spring Loaded 165mm

Order Code	Description
FC-TSL-S-12	Small Tartar Forceps Straight Jaw Spring Loaded 120mm
FC-TSL-L-16	Large Tartar Forceps Straight Jaw Spring Loaded 165mm

A selection of extraction forceps used for lifting the teeth. They have serrated tips to improve grip on the tooth.

Order Code	Description
FC-DE-L-15	Dental Extraction Forceps Small 150mm
FC-DE-L-16	Dental Extraction Forceps Large 160mm
FC-DE-HWK-A	Hawksbill Extraction Forceps Angled 150mm
FC-DE-HWK-C	Hawksbill Extraction Forceps Curved 170mm

Lip Retractor

Predominantly used to move the lip out of the way whilst working in the mouth. Silicone tip reduces trauma.

Order Code	Description
LR-160	Lip Retractor with Silicone Tip 160mm

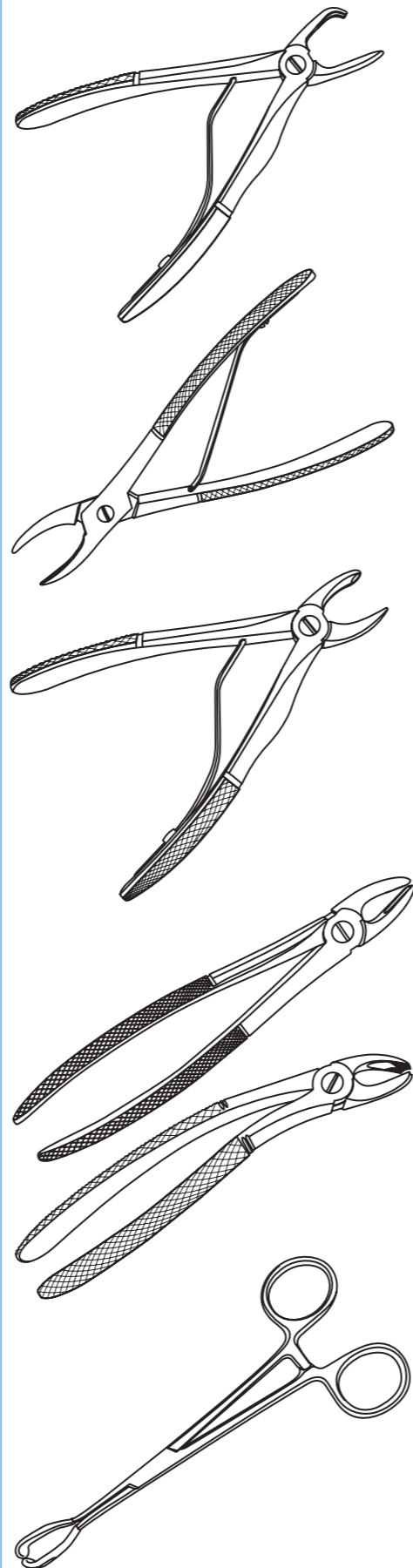

Dental Kits

Feline and Canine Dental Kits containing the basic instruments required, the kits come in a stainless steel box and are heavily discounted against buying individually.

Order Code	Description
DENTAL-CAT	Feline Dental Kit
Each kit comprises:	Winged Elevator Set 1mm-4mm, Dental Extraction Forceps Small, Tartar Forceps Small, Periosteal Elevator Small, Explorer Probe, Subgingival Curette, Supragingival Curette
DENTAL-DOG	Canine Dental Kit
Each kit comprises:	Winged Elevator Set 1mm-4mm, Dental Extraction Forceps Large, Tartar Forceps Large, Periosteal Elevator Large, Explorer Probe, Subgingival Curette, Supragingival Curette

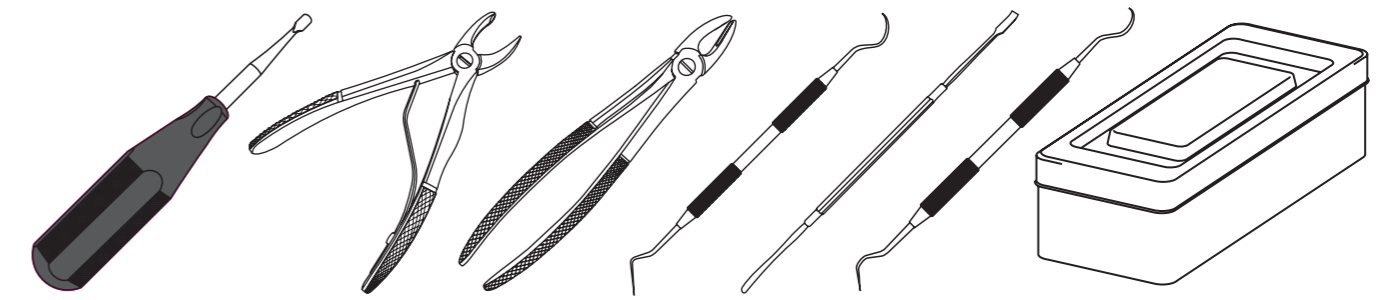

Mouth Gags

Basic rabbit/rodent mouth gag, simply fits on the lower and upper incisors and screw is turned to open to appropriate height. N2's gag comes with silicone protectors on the tips for protection of the incisors.

Order Code	Description
GAG-RM-S	Rodent Mouth Gag with Silicone Tip

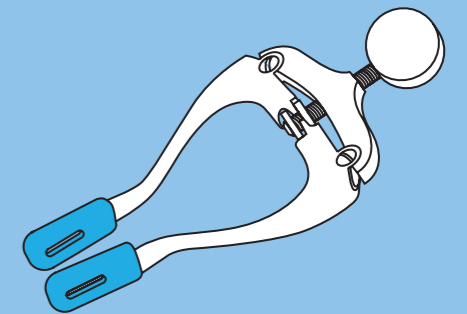

A replacement in the form of an extra pair of hands, this useful piece of kit allows the patient to be angled for optimum visibility of the mouth. Floor angle is fully adjustable along with jaw positions. Blue Teflon base retains its heat better than steel, minimising temperature loss to the patient.

Order Code	Description
GAG-TT	Rabbit/Rodent Table Top Gag

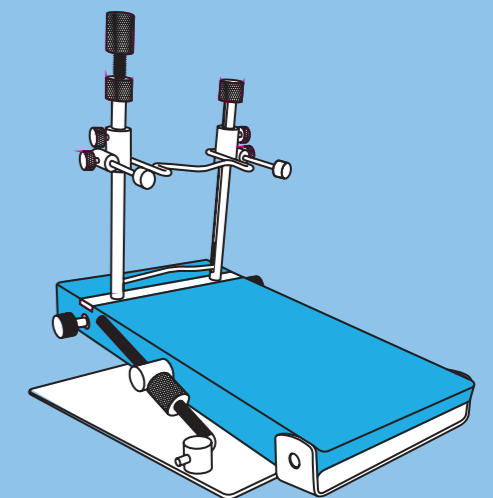

Luxations Incisor

Small version of periosteal elevator. Thin sharp curved blade fits down the rodent's gumline to break through ligaments before extraction.

Order Code	Description
LX-IN-S-18	Incisor Luxation Rodent/Rabbit 180mm Small
LX-IN-L-18	Incisor Luxation Rodent/Rabbit 180mm Standard

Designed to inspect the health of animals teeth and surrounding gums, a very useful instrument.

Order Code	Description
ML-16	Molar Luxation 160mm

Thin forcep used to lift rodent teeth once ligaments have been severed.

Order Code	Description
FC-RM-16	Rodent Molar Extraction Forceps 160mm

Molar Cutters

Used for general trimming of rodent teeth.

Order Code	Description
CT-RM-14	Rodent Molar Cutter 140mm
CT-RM-18	Rodent Molar Cutter 180mm

Order Code	Description
CT-RM-HD-18	Rodent Molar Cutter Heavy Duty 185mm

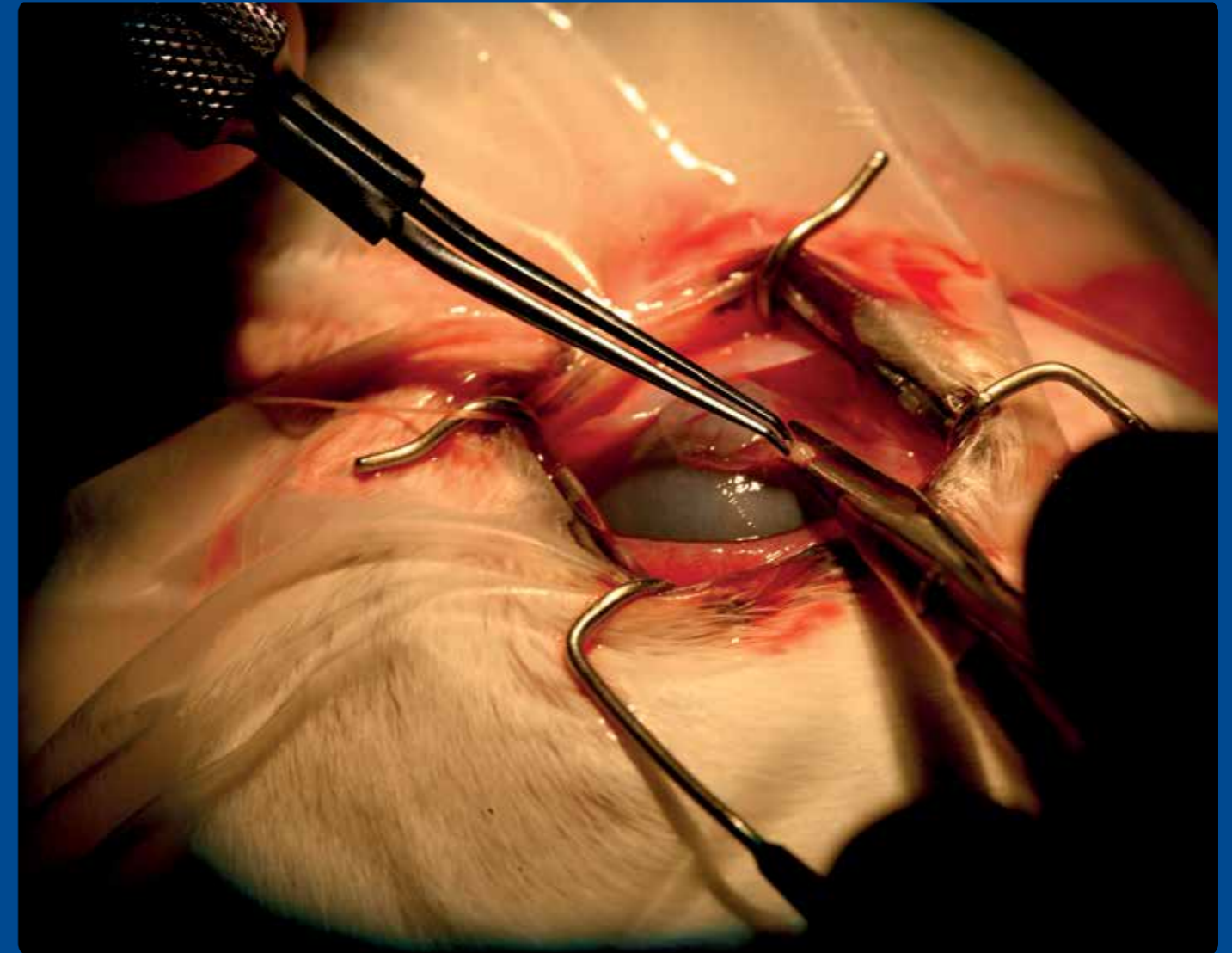
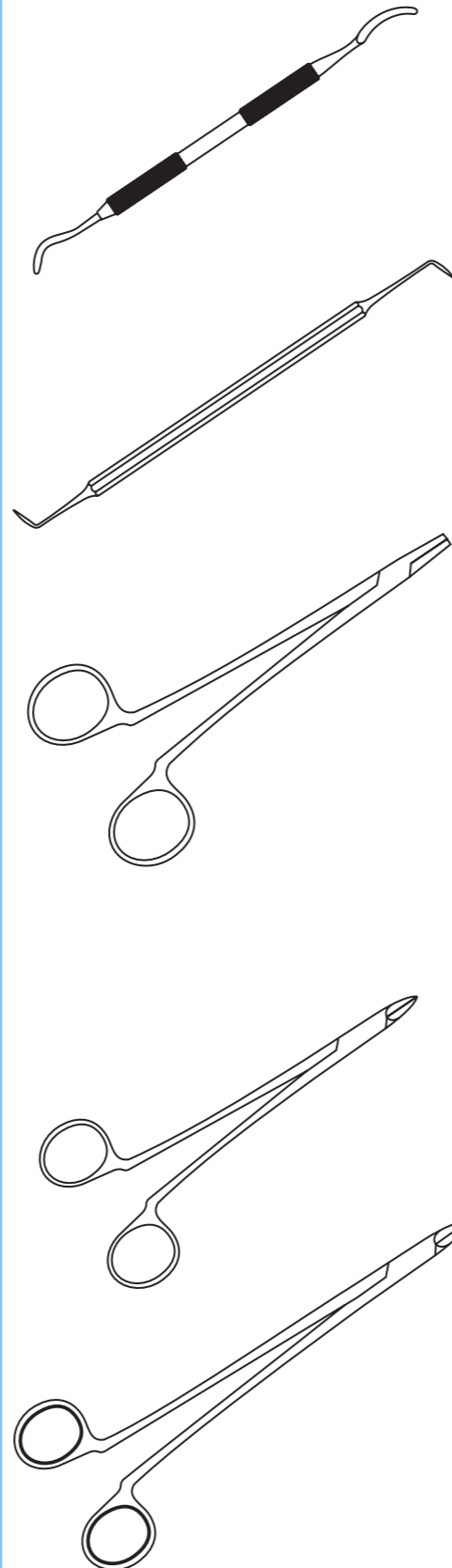

Instruments - Ophthalmic

Lightweight flexible wire speculum used for holding open the eyelid.

Order Code	Description
ES-B-25/5	Barraquer Eyelid Speculum 25mm Gape 5mm Blade
ES-B-30/10	Barraquer Eyelid Speculum 30mm Gape 10mm Blade

Most commonly used forcep on the market for corneal work.

Order Code	Description
FC-SMC-90	St Martins Corneal Forceps 90mm

Forceps are modified to fit the shape of the eye and clamp the blood vessels behind the eye, allowing it to be levered up, the enucleation scissors are then used to cut the optic nerve.

Order Code	Description
FC-EN-13	Eye Enucleation Forceps 135mm
SC-EN-13	Eye Enucleation Scissors 135mm

Enucleation Spoon is a specialized surgical tool that surgeons can use to remove all the intraocular contents from the eye socket. The spoon is grooved to allow the optic nerve and vessels to be accommodated.

Order Code	Description
SP-EN-15	Eye Enucleation Spoon (Wells) 150mm

Small speculum which can be easily adjusted in-situ.

Order Code	Description
ES-COOK	Cook Eyelid Speculum 45mm

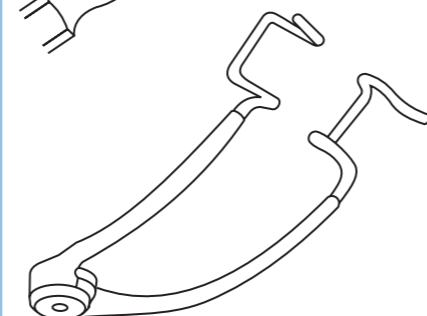
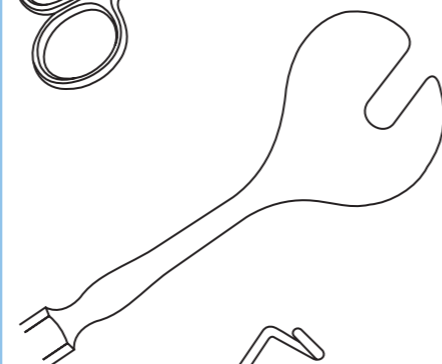
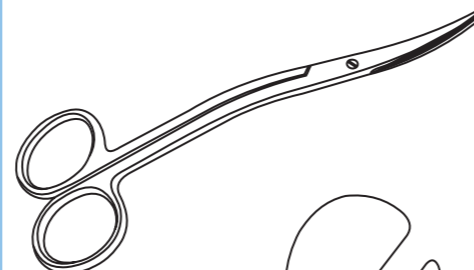
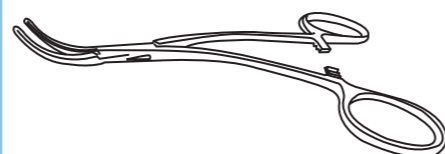
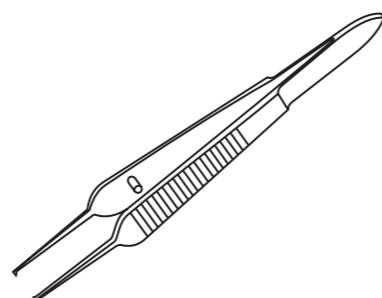
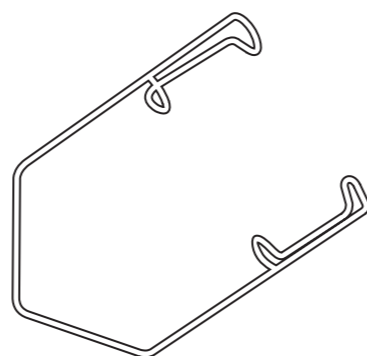

Needle Holders - Ophthalmic

Micro size needle holder/scissors – ophthalmic combined. Designed predominantly for gripping fine needles and sutures in ophthalmic surgery. Comes in a range of standard steel, tungsten carbide and supercut tungsten carbide options.

Order Code	Description
NH-S-C-15-TC-CV	Castroviejo Needle Holder/Scissors Curved T.C. 150mm
NH-S-C-15-TC-ST	Castroviejo Needle Holder/ Scissors Supercut T.C. 150mm
NH-S-C-15-TCSC-CV	Castroviejo Needle Holder/Scissors Curved Supercut T.C. 150mm
NH-S-C-15-TCSC-ST	Castroviejo Needle Holder/Scissors Straight Supercut T.C. 150mm

Order Code	Description
NH-C-12-TC-ST	Castroviejo Needle Holder Straight T.C. 120mm
NH-C-15-TC-ST	Castroviejo Needle Holder Straight T.C. 150mm
NH-C-18-TC-ST	Castroviejo Needle Holder Straight T.C. 180mm

T.C. = Tungsten Carbide.

Scissors - Ophthalmic

Most commonly used scissors in ophthalmic procedures, small in size with sharp narrow tips.

Order Code	Description
SC-IS-9-CV	Iris Scissors Curved 90mm
SC-IS-9-ST	Iris Scissors Straight 90mm

Fine scissors used for cutting suture material used in ophthalmic surgery.

Order Code	Description
SC-SS-C-12	Castroviejo Suture Scissors 120mm

Sharp pointed scissors with a long handle allowing surgeon delicate control whilst maintaining a good site view.

Order Code	Description
SC-ST-11-CV	Stevens Tenotomy Scissors Curved 110mm
SC-ST-11-ST	Stevens Tenotomy Scissors Straight 110mm

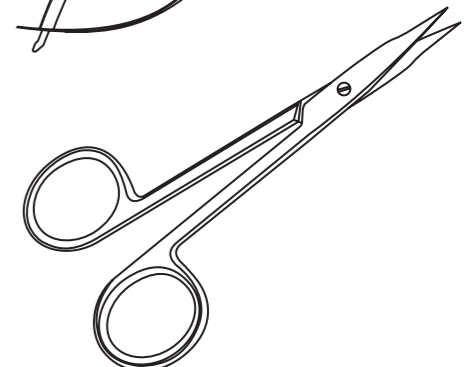
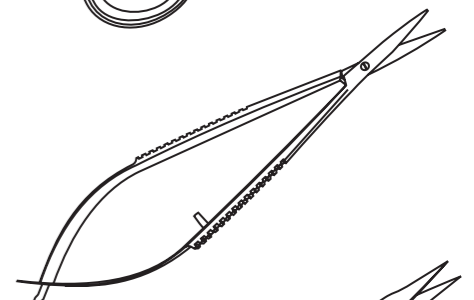
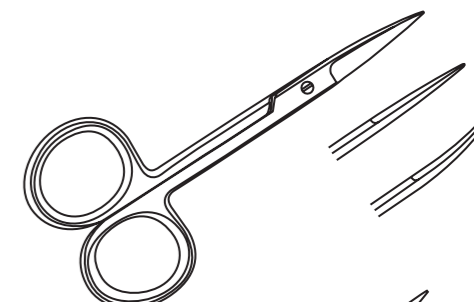
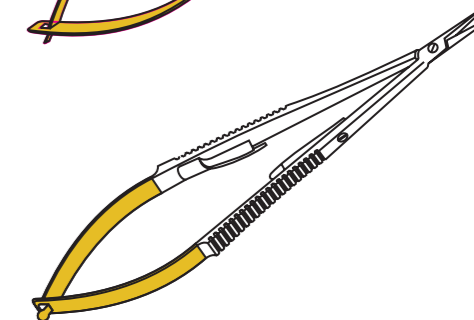
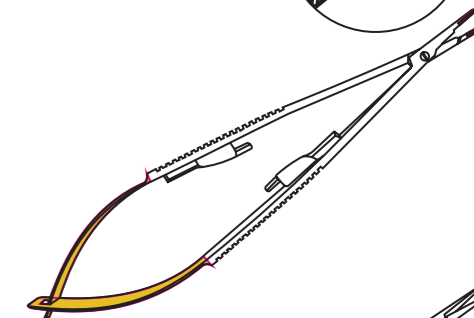
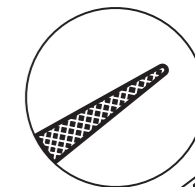

Scissors - Ophthalmic cont.

Order Code	Description
SC-IS-12-SC-CV	Iris Scissors Fine Curved Supercut 120mm – Sharp/Sharp

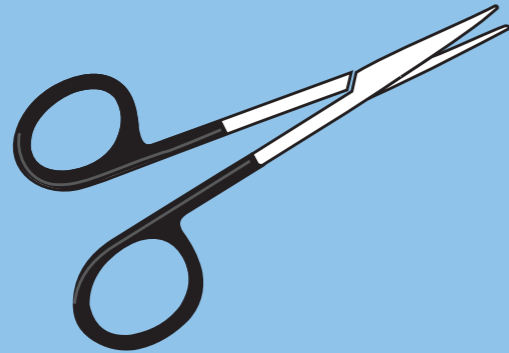

Ophthalmic Kit

We have created a basic kit containing the most useful items for most common ophthalmic procedures offering a good range of instruments and value. A must for all practices to cover the basic ophthalmic needs.

Order Code	Description
OP-KIT-STD	Basic Ophthalmic Kit
Each kit comprises:	Halstead Mosquito Forceps 100mm Curved x 1, Halstead Mosquito Forceps 100mm Straight x 1, Barraquer Wire Eyelid Speculum 30mm Gape 10mm Blade x 1, St Martins Corneal Forceps 90mm x 1, Graefe Fixation Forceps 105mm x 1, Iris Forceps 1/2 Teeth 100mm x 1, Roberts Tying Forceps 100mm x 1, Castroviejo Needle Holder with Scissor Straight T.C. 150mm x 1, Stevens Tenotomy Scissors Curved 110mm x 1, Stevens Tenotomy Scissors Straight 110 x 1, Beaver Blade Handle 130mm x 1, Jones Towel Clips 90mm x 2, Autoclavable Storage Box and Silicone Mat

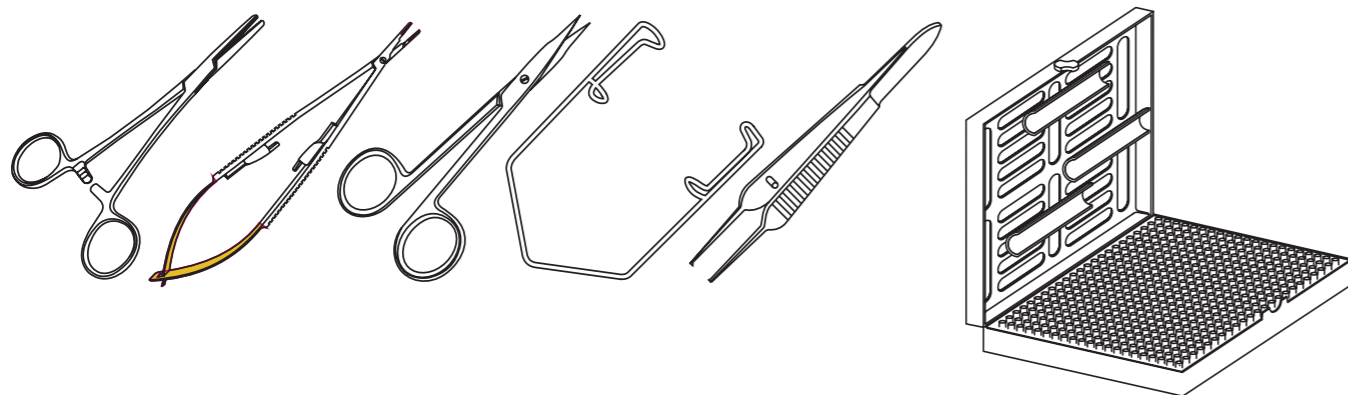

N2 Victory Modular System

Based around the Braun Containers which are considered the best on the market. We know every surgeon likes to arrange their kits differently, some like one size altogether for example a 2.7mm kit containing 2.7mm locking, DCP and Evolox® together where others like locking kits separate from cortical kits etc.



We have pioneered a modular system that allows this choice and for your kits to evolve as your techniques do. Please contact us to help build your kit.

We have tried to offer various options to suit all needs and budgets.

Our black Victory range is expanding to include more combinations of screws and plates.

Step 1: choose your container

These boxes have a space for a filter in the lid and base meaning once closed and sterilised the contents stay sterile for up to 12 months. No more wrapping and bagging needed, helping both the environment and your pocket. No more ripped bags meaning you have to resterilise the contents. Contact us if your size options aren't covered as there are hundreds of options available.

Order Code	Description
JN092	Sterile Box 313 x 190 x 46mm Outside Diameter
JN094	Sterile Box 313 x 190 x 65mm Outside Diameter
JN095	Sterile Box 313 x 190 x 92mm Outside Diameter* (1)
JN096	Sterile Box 313 x 190 x 130mm Outside Diameter

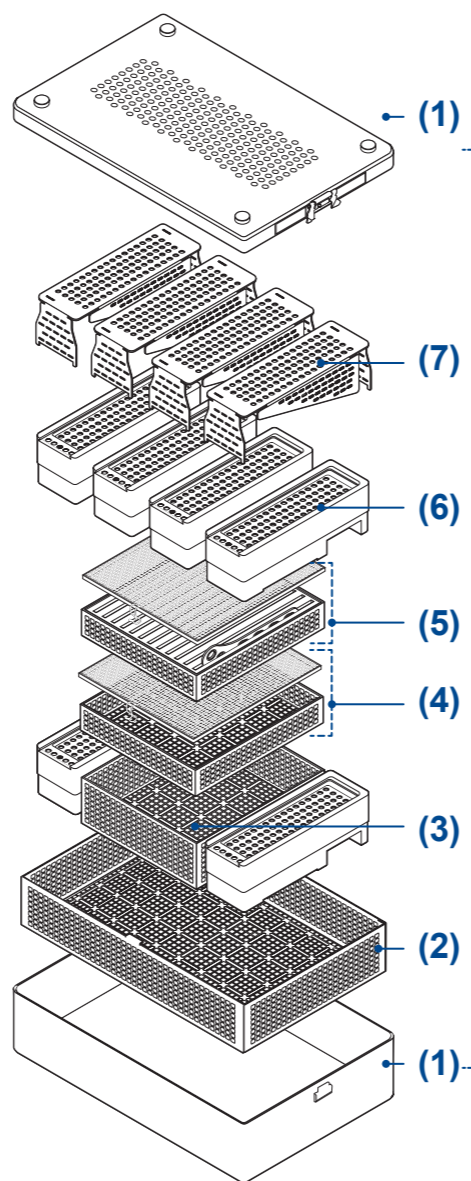

N2 Victory Modular System cont.

Step 2: choose your mesh baskets

There are various combinations available to either fit one basket in a box or two different sized ones. These allow the sterile surgeon to lift the contents out of the box without compromising sterility. All our rectangular screw racks are designed to fit into the JG285R baskets in a variety of combinations (see diagram).

Order Code	Description
JF289R/JF282R	Basket 273mm x 176mm x 100mm Outside Diameter (FITS JN096 BOX ONLY)
JG285R	Basket 273mm x 176mm x 60mm Outside Diameter (FITS IN JN095 & JN096)* (2)
JG383R	Basket with 3 Instrument Racks 273mm x 176mm x 30mm
JG384R	Basket with 3 Instrument Racks 273mm x 176mm x 41mm



* Recommended kit sizes

Step 3: choose your racks

Our racks are designed to fit snugly inside JG285R, up to 4 screw racks will fit the box or two racks and our inner storage baskets. We have designed a large selection of screw, plate and accessory racks to fit into this system making them useful for all orthopaedic kits as well as standard instrument kits.

Order Code	Description
PM-RACK-242735	Premium Aluminium Screw Racks for 2.4/2.7/3.5mm Screws (2.4) 8 to 22mm, (2.7) 10 to 24mm, (3.5) 14 to 30mm Ideal for TPLO Cortical Screws (6)
PM-RACK-1520	Premium Aluminium Screw Racks for 1.5 and 2.0mm Screws 6mm to 20mm (6)
PM-RACK-20	Premium Aluminium Screw Racks for 2.0mm Locking Screws and Locking Plates 6mm to 26mm (6)
PM-RACK-2024	Premium Aluminium Screw Racks for 2.0mm Screws with a 2.4mm head 6mm to 40mm (6)
PM-RACK-24	Premium Aluminium Screw Racks for 2.4mm Screws 6mm to 40mm (6)
PM-RACK-27	Premium Aluminium Screw Racks for 2.7mm Screws 10mm to 40mm (6)
PM-RACK-35	Premium Aluminium Screw Racks for 3.5mm Screws 14mm to 42mm (6)
PM-RACK-HYBRID-LOCK	Empty Hybrid Premium Screw Rack



N2 Victory Modular System cont.

Step 3: choose your racks cont.

Our new premium rack range have space for the most common locking and cortical screws in one rack. Ideal for TPLO kits but also useful for our combi plates with locking and compression holes.

Order Code	Description
PM-RACK-20-CL	Premium Screw Rack for 2.0mm Cortical and Locking Screws
PM-RACK-24-CL	Premium Screw Rack for 2.4mm Cortical and Locking Screws
PM-RACK-27-CL	Premium Screw Rack for 2.7mm Cortical and Locking Screws
PM-RACK-35-CL	Premium Screw Rack for 3.5mm Cortical and Locking Screws

Order Code	Description
ST-RACK-1520	Standard Screw Rack for 1.5mm and 2.0mm Screws (1.5) 6mm to 20mm (2.0) 6mm to 22mm (7)
ST-RACK-24	Standard Screw Rack for 2.4mm Screws 6mm to 50mm (7)
ST-RACK-27	Standard Screw Rack for 2.7mm Screws 6mm to 50mm (7)
ST-RACK-35	Standard Screw Rack for 3.5mm Screws 8mm to 50mm (7)
ST-RACK-242735	Standard Screw Rack for 2.4/2.7/3.5mm Screws Ideal for TPLO Cortical Screws (7)

Order Code	Description
IN-PLT-EVO-27	Plate Storage Tray for 2.7mm Evolox Range Premium Aluminium
IN-PLT-EVO-35	Plate Storage Tray for 3.5mm Evolox Range Premium Aluminium

Other plate rack sizes available on request.

Order Code	Description
KIT-INS-TPLO-BK	Premium TPLO Plate Tray and Mesh Basket (JG384R) (5)
KIT-INS-TPLO	Adjustable Rack insert for Premium TPLO Kit

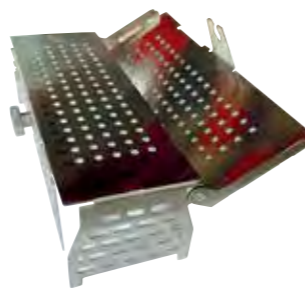

N2 Victory Modular System cont.

Step 3: choose your racks cont.

Order Code	Description
IN-BASK-23	Inner Storage Basket for Screw Kits 140mm x 140mm x 23mm (double up for mixed kits) (4)
IN-BASK-46	Inner Storage Basket for Screw Kits 140mm x 140mm x 46mm (3)
MAT-KIT-STOR	Silicone Mat to Fit Above Baskets
IN-BASK-PREM-BOX	Inner Storage Basket for Screw Kits 115mm x 160mm x 50mm with Lid

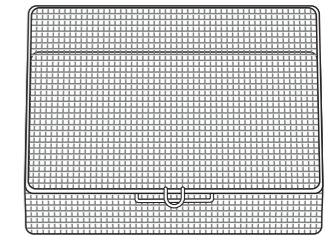

Step 4: choose any accessories

Order Code	Description
ID-TAG	Identification Tags. Please choose colour and wording (13 characters max)
JG645B	Red
JG646B	Blue
JG647B	Green
JG648B	Gold
JG650B	Black
JG653B	Violet
JG654B	Orange
Premium Box Accessories	
JG687	Indicator Labels
JF945	Silicone Mat with Perforations – Cuttable
JF938	Silicone Mesh Mat - Cuttable
JK091	Permanent Filters (up to 1000 cycles)
JF166	Single Use Paper Filters Pack of 100
JG370	Silicone Dividers 240mm x 30mm
PAD-STER-100	Pack of 100 Tamperproof Padlocks with Steam Indicators
PAD-STER-1000	Pack of 1000 Tamperproof Padlocks with Steam Indicators



JG687 Indicator Labels



ID-TAG Identification Tags



JF945 Silicone Mat with Perforations – Cuttable

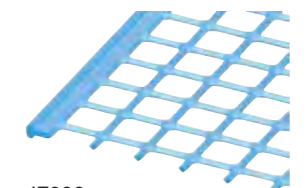

JF938 Silicone Mesh Mat – Cuttable



JK091 Permanent Filters



JF166 Single Use Paper Filters

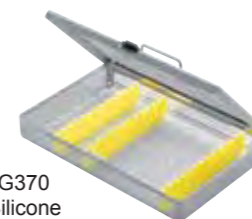

JG370 Silicone Dividers



PAD-STER-100 Padlock

N2 Victory Modular System cont.

Step 4: choose any accessories cont.



Order Code	Description
PM-RACK-1520-CORT	Full Premium Rack of 1.5mm and 2.0mm Cortical Screws
PM-RACK-24-CORT	Full Premium Rack of 2.4mm Cortical Screws
PM-RACK-27-CORT	Full Premium Rack of 2.7mm Cortical Screws
PM-RACK-35-CORT	Full Premium Rack of 3.5mm Cortical Screws

Order Code	Description
PM-RACK-1520-LOC	Full Premium Rack of 1.5/2.0mm Locking Screws
PM-RACK-20-LOC	Full Premium Rack of 2.0mm Locking Screws
PM-RACK-2024-LOC	Full Premium Rack of 2.0/2.4mm Locking Screws
PM-RACK-24-LOC	Full Premium Rack of 2.4mm Locking Screws
PM-RACK-27-LOC	Full Premium Rack of 2.7mm Locking Screws
PM-RACK-35-LOC	Full Premium Rack of 3.5mm Locking Screws

Order Code	Description
ST-RACK-20-CL	2.0mm Combination Screw Racks for Cortical and Locking Screws
ST-RACK-24-CL	2.4mm Combination Screw Racks for Cortical and Locking Screws
ST-RACK-27-CL	2.7mm Combination Screw Racks for Cortical and Locking Screws
ST-RACK-35-CL	3.5mm Combination Screw Racks for Cortical and Locking Screws



Premium Instrument Boxes

We have added a selection of premium boxes and accessories that are common in the veterinary market. Contact us if you can't see a size you are looking for.

Boxes

Order Code	Description
JN187	Box with Filter Slot 310 x 140 x 40mm
JN188	Box with Filter Slot 310 X 140 X 67mm



JN187
Box with Filter Slot 310 x 140 x 40mm



JN188
Box with Filter Slot 310 x 140 x 67mm

Lids

Order Code	Description
JK170-RED	Lid for Box – Red
JK171-BLUE	Lid for Box – Blue
JK172-GREEN	Lid for Box – Green
JK173-GOLD	Lid for Box – Gold
JK174-SILVER	Lid for Box – Silver



JK170-RED



JK171-BLUE



JK172-GREEN



JK173-GOLD



JK174-SILVER

Premium Instrument Baskets

Containers

Order Code	Description
JF149R	Instrument Tray with Lid 135 x 120 x 347mm (2 fit in JN188)
JF159R	Instrument Tray with Lid 267 x 125 x 49mm
JF436R	Arthroscope Tray

Contact us for more options if you can't see a size that you want.



JF149R



JF159R



JF436R

Ask us about our Modular Kit Peg System – coming soon.

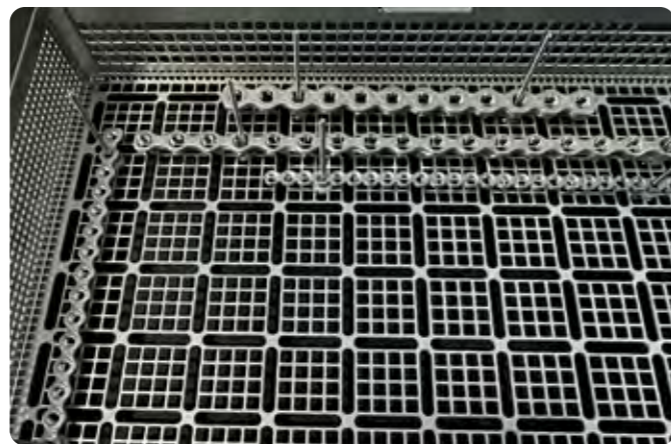
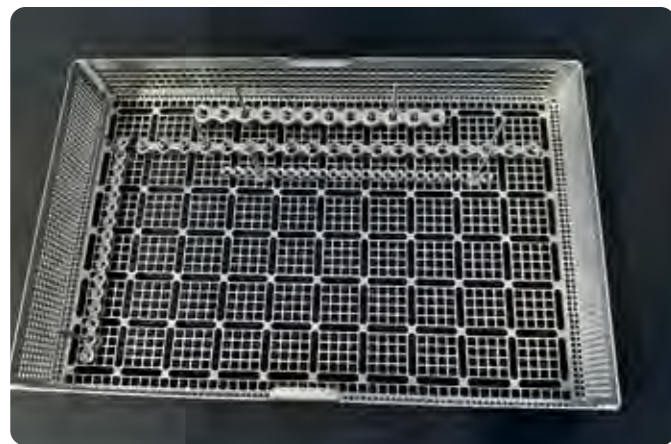

Hybrid Locking Kit



Our Hybrid Locking screws are getting more and more popular with our customers due to their usefulness in many situations and are a great product to have sterilised in your practice for those unexpected cases.

On top of this we now have the new locking adapter. This screws into a 3.5mm Locking/Evolox plate and allows you to use a 2.4mm or 2.7mm screw in any 3.5mm plates polyaxially.

It also has a slot on the washer to allow you to remove it for any reason.

The Complete kit is available preloaded with a full set of the hybrid screws in a premium screw rack along with 2 of the Locking adapters and one of each required Locking drill Guides.

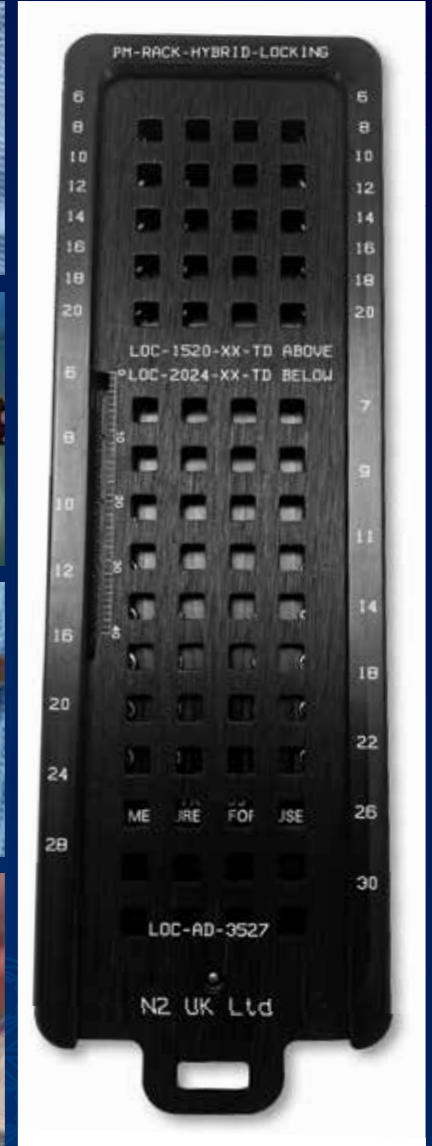
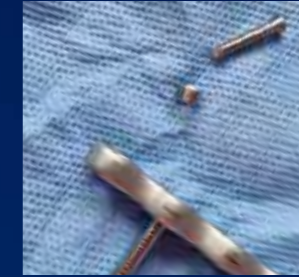

Order Code	Description
PM-RACK-HYBRID-LOCK	Empty Hybrid Premium Screw Rack
KIT-RACK-HYBRID-LOCK	Full Hybrid Screw Washer Kit in Premium Screw Rack
LOC-AD-35-2427	Locking Adapter -3.5mm down to 2.4/2.7mm



- www.n2-uk.com
- +44 (0)23 9323 3265
- @n2ukcom
- www.facebook.com/n2ukltd
- sales@n2-uk.com
- office@n2-uk.com for orders

Images courtesy of Dr Ben Garland BVetMed CertAVP(GSAS) MRCVS RCVS Advanced Practitioner in Small Animal Surgery. Director. DVSR - Debenham Vets Surgical Referrals Ltd.

Premium Kits

To expand on our Evolox kits we now offer the same implants in our premium boxes and screw racks. The combination of implant and storage options is very large and we invite customers to send us their needs to help tailor kits to their own personal requirements.

As it's a significant investment we offer a loan kit to allow you to try before you buy and also the ability to spread payments over a few months to help offset the investment. Our standard locking plates and our Evolox polyaxial range use the exact same screws so our plates are fully interchangeable with each system keeping your inventory levels low.

We have pioneered the 2024 screw which is a locking screw with a 2.4mm head and a 2.0mm shaft. This means it can fit in any of our 2.4mm and 2.7mm locking plates but the narrower shaft allows it to fit into smaller bones or also to target small fragments. Contact us for more information and prices.

An example of a premium kit is listed below.



Order Code	Description	Qty
LOC-27-06/32-TD	2.7mm Locking Screw (Self Tapping Torx Drive) 6mm to 32mm	5
LOC-35-10/34-TD	3.5mm Locking Screw (Self Tapping Torx Drive) 10mm to 34mm	5
EV-OS-27-04/14	2.7mm Evolox® Plates 4 hole - 14 hole	1
EV-OS-35-04/14	3.5mm Evolox® Plates 4 hole - 14 hole	1
PM-RACK-27/35	Premium Screw Racks 2.7mm and 3.5mm	1
IN-PLT-EVO-27/35	Premium Plate Trays 2.7mm and 3.5mm	1
JN096	Premium Sterile Box 313 x 190 x 46mm	1
JG285R	Premium Basket 273 x 176 x 60mm	1
JG383R	Premium Basket 273 x 176 x 30mm	1
JG390	Silicone Dividers	1
EV-PB-2735	Evolox® Plate Benders 2.7/3.5mm	1
SGH-QF	Premium Screwdriver Quick Fit Handle	1
SDT-QR-T6/T8/T15	Quick Fit Screwdriver Tips Torx - T6,T8 and T15	1
SHS-T6/T8/T15	Screw Holding Sleeves for T6, T8 and T15 Tips	1
DRL-20-080	2.0mm Drill Bit	1
DRL-27-100	2.7mm Drill Bit	1
DE-GA-2735-PREM	Premium Depth Gauge for 2.7/3.5mm Screws	1
LOC-2724/35-PTD	Torx Locking Plugs for 2.7 and 3.5mm Plates	5
LOC-27/35-DGS	Drill Guides for 2.7/3.5mm Kits	2

Cortical Kits

Order Code	Description
KIT-COR-ST-1520	1.5mm/2.0mm Cortical Screws - Hex Drive and Plate Kit Each kit comprises: 1.5mm Cortical Self-tapping Screws 6-20mm x 5, 1.5mm Compression Plates 4-8 Holes (5 Plates), 2.0mm Cortical Self Tapping Screws 6-20mm x 5, 2.0mm Compression Plates 4 -8 holes (5 Plates), Screwdriver, Depth Gauge, Load/Neutral Drill Guide, Insert Sleeve, Drill Bits x 3, Screw Measuring Gauge, Plate Benders, Combination Drill, Tap and Insert Sleeve, Bending Template, Mesh Basket, Screw/Plate Trays, Sterile Container Box.
KIT-COR-ST-20	2.0mm Cortical Screws - Hex Drive and Plate Kit Each kit comprises: 2.0mm Cortical Self-tapping Screws 6 – 20mm x 5, 2.0mm Compression Plates 4-8 Holes (5 Plates), Screwdriver, Depth Gauge, Load/Neutral Drill Guide, Insert Sleeve, Drill Bits, Plate Benders, Combination Drill/Tap and Insert Sleeve, Bending Template, Screw Measuring Gauge, Mesh Container, Screw/plate Tray, Sterilisable Box.
KIT-COR-ST-24	2.4mm Cortical Screw - Hex Drive and Plate Kit
KIT-COR-ST-24-TD	2.4mm Cortical Screw and Plate Kit With Star Torx Head Screws Each kit comprises: 2.4mm Cortical Self-tapping Screws 6-30mm x 5, 2.4mm Compression Plates 4-14 Hole (11 Plates), Screwdriver, Load/Neutral Drill Guide, Drill Bits x 2, Bending Template, Plate Benders, Mesh Basket, Screw/Plate Trays, Sterile Container Box.
KIT-COR-ST-27	2.7mm Cortical Screw - Hex Drive and Plate Kit
KIT-COR-ST-27-TD	2.7mm Cortical Screw and Plate Kit With Star Torx Head Screws Each kit comprises: 2.7mm Cortical Self-tapping Screws 6-30mm x 5, 2.4mm Compression Plates 4-14 Hole (11 Plates), Screwdriver, Load/Neutral Drill Guide, Drill Bits x 2, Bending Template, Plate Benders, Mesh Basket, Screw/Plate Trays, Sterile Container Box.
KIT-COR-ST-2735	2.7/3.5mm Cortical Screw - Hex Drive and Plate Kit
KIT-COR-ST-2735-TD	2.7/3.5mm Cortical Screw and Plate Kit With Star Torx Head Screws Each kit comprises: 2.7mm Cortical Self-tapping Screws 6-8mm x 3, 10mm x 4, 12-20mm x 5, 22mm x 4, 24mm x 3, 26-30mm x 2, 2.7mm Compression Plates 4-10 Holes (6 Plates) 3.5mm Cortical Self-tapping Screws 10-12mm x 4, 14-26mm x 5, 28mm x 4, 30-32mm x 3, 3.5mm Compression Plates 4-10 Holes (6 Plates), Bending Templates x 2, Plate Benders, Screwdrivers x 3, Depth Gauge, Countersink, Load/neutral Drill Guides x 2, Combination Drill/Tap/Sleeve x 2, Drill Bits x 4, Screw Measuring Gauge, Mesh Basket, Screw/Plate Trays, Sterile Container Box.

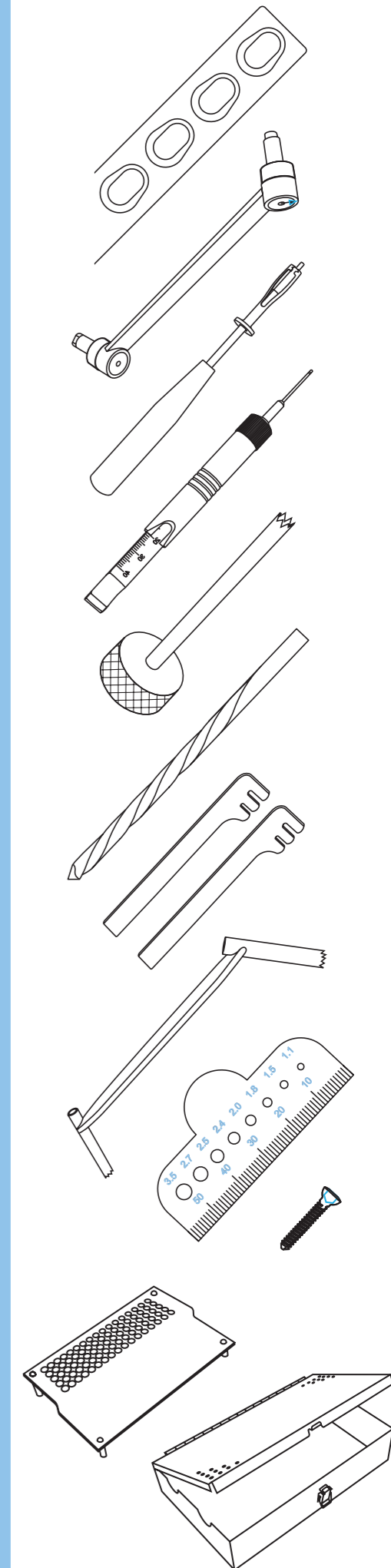

*Practice discounts do not apply to kits as already heavily discounted.

For full terms and conditions please visit our website.

Locking Kits

Order Code	Description
KIT-LOC-24	2.4mm Locking Kit - Hex Head
KIT-LOC-24-TD	2.4mm Locking Kit - Star Torx Head
<p>Each kit comprises: 2.4mm Locking Screws 6-10mm x 3, 12-14mm x 4, 16-24mm x 5, 26-34mm x 4, 36-38mm x 3, 2.4mm Locking Plates 4-14mm (11 Plates), Screwdriver, Locking Drill Guide, Depth Gauge, Drill Bits x 1, Locking Plugs x 5, Screw Holding Forceps, Plate Benders, Mesh Basket, Screw/Plate Tray, Sterile Container Box.</p>	
KIT-LOC-27	2.7mm Locking Kit - Hex Head
KIT-LOC-27-TD	2.7mm Locking Kit - Star Torx Head
<p>Each kit comprises: 2.7mm Locking Screws 6-8mm x 3, 10-14mm x 4, 16-20mm x 5, 22-32mm x 4, 34-38mm x 3, 2.7mm Locking Plates 4-14 Holes (11 Plates), Screwdriver, Locking Drill Guide, Depth Gauge, Drill Bit, Locking Plugs x 5, Screw Holding Forceps, Plate Benders, Mesh Basket, Screw/Plate Tray, Sterile Container Box.</p>	
KIT-LOC-35	3.5mm Locking Kit - Hex Head
KIT-LOC-35-TD	3.5mm Locking Kit - Star Torx Head
<p>Each kit comprises: 3.5mm Locking Screws 10-14mm x 4, 16-20mm x 5, 22-32mm x 4, 34-42mm x 3, 3.5mm Locking Plates 4-14 Holes (11 Plates), Screwdriver, Locking Drill Guide, Depth Gauge, Drill Bit, Locking Plugs x 5, Screw Holding Forceps, Plate Benders, Mesh Basket, Screw/Plate Tray, Sterile Container Box.</p>	
KIT-LOC-2427	2.4/2.7mm Locking Kit - Hex Head
KIT-LOC-2427-TD	2.4/2.7mm Locking Kit - Star Torx Head
<p>Each kit comprises: 2.4mm Locking Screws 6-10mm x 3, 12-14mm x 4, 16-24mm x 5, 26-34mm x 4, 36-38mm x 3, 2.4mm Locking Plates 4-14 Holes (11 Plates), 2.7mm Locking Screws 6-8mm x 3, 10-14mm x 4, 16-20mm x 5, 22-32mm x 4, 34-38mm x 3, 2.7mm Locking Plates 4-14 Holes (11 Plates), Locking Drill Guides x 2, Depth Gauge, Drill Bits x 2, Locking Plugs x10, Screw Holding Forceps, Plate Benders x 2, Mesh Basket, Screw/Plate Trays, Sterile Container Box.</p>	
KIT-LOC-2735	2.7/3.5mm Locking Kit - Hex Head
KIT-LOC-2735-TD	2.7/3.5mm Locking Kit - Star Torx Head
<p>Each kit comprises: 2.7mm Locking Screws 6-8mm x 3, 10-14mm x 4, 16-20mm x 5, 22-32mm x 4, 34-38mm x 3, 2.7mm Locking Plates 4-14 Holes (11 Plates), 3.5mm Locking Screws 10-14mm x 4, 16-20mm x 5, 22-32mm x 4, 34-40mm x 3, 3.5mm Locking Plates 4-14 Holes (11 Plates), Screwdrivers x 2, Locking Drill Guides x 2, Depth Gauge, Drill Bits x 2, Locking Plugs x 10, Screw Holding Forceps, Plate Benders, Mesh Basket, Screw/Plate Trays, Sterile Container Box.</p>	

*Practice discounts do not apply to kits as already heavily discounted.

Evolox® Kits

Order Code	Description
KIT-EVO-27	2.7mm Evolox® Kit with Screws and Full Set of 2.7mm Plates - Hex Drive
KIT-EVO-27-TD	2.7mm Evolox® Kit with Screws and Full Set of 2.7mm Plates - Star Torx Drive
<p>Each kit comprises: 2.7mm Locking Screws 6-14mm x 4, 16-20mm x 5, 22-32mm x 4, 2.7mm Evolox® Plates 4-14 Holes (11 Plates), Screwdriver, Evolox® Plate Benders, Drill Bit, Depth Gauge, Locking Plugs x 5, Locking Drill Guide, Mesh Basket, Screw/Plate Tray, Sterile Container Box.</p>	
KIT-EVO-35	3.5mm Evolox® Kit with Screws and Full Set of 3.5mm Plates - Hex Drive
KIT-EVO-35-TD	3.5mm Evolox® Kit with Screws and Full Set of 3.5mm Plates - Star Torx Drive
<p>Each kit comprises: 3.5mm Locking Screws 10-14mm x 4, 16-26mm x 5, 28-34mm x 4, 3.5mm Evolox® Plates 4-14 Holes (11 Plates), Screwdriver, Evolox® Plate Benders, Drill Bit, Depth Gauge, Locking Plugs x 5, Locking Drill Guide, Mesh Basket, Screw/Plate Tray, Sterile Container Box.</p>	
KIT-EVO-2427	2.4/2.7mm Evolox® Kit with Screws and 2.4/2.7mm Plates - Hex Drive
KIT-EVO-2427-TD	2.4/2.7mm Evolox® Kit with Screws and 2.4/2.7mm Plates - Star Torx Drive
<p>Each kit comprises: 2.4mm Locking Screws 6-10mm x 3, 12-14mm x 4, 16-24mm x 5, 26-34mm x 4, 36-38mm x 3, Evolox® Cuttable Locking Plate, Evolox® Cuttable Malleable Locking Plate, 2.7mm Locking Screws 6-8mm x 3, 10-14mm x 4, 16-20mm x 5, 22-32mm x 4, 34-38mm x 3, 2.7mm Evolox® Plates 4-14 Holes (11 Plates), Screwdriver, Locking Drill Guides x 2, Depth Gauge, Drill Bits x 2, Locking Plugs x 10, Screw Holding Forceps, Evolox® Plate Benders, Mesh Basket, Screw/Plate Trays, Sterile Container Box.</p>	

*Practice discounts do not apply to kits as already heavily discounted.

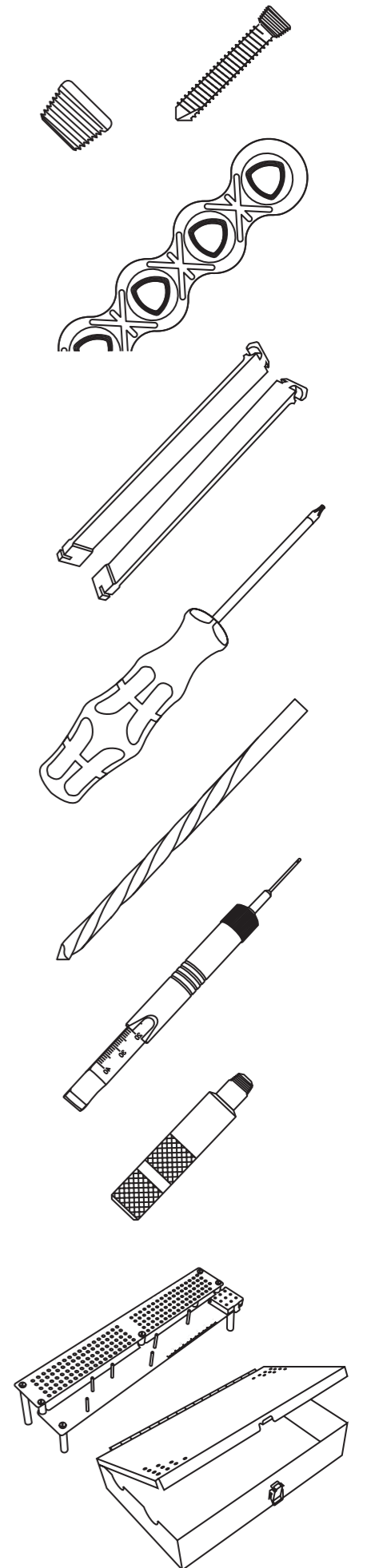
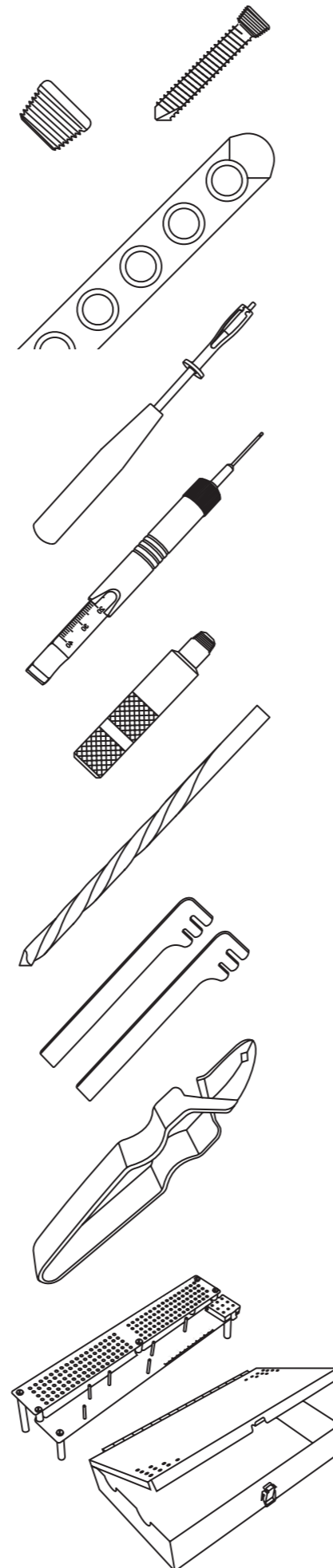

Evolox® Standard Kits

Order Code	Description
KIT-EVO-2735	2.7/3.5mm Evolox® Kit with Screws and 2.7/3.5mm Plates - Hex Drive
KIT-EVO-2735-TD	2.7/3.5mm Evolox® Kit with Screws and 2.7/3.5mm Plates - Star Torx Drive
Each kit comprises: 2.7mm Locking Screws 6-14mm x 4, 16-20mm x 5, 22-32mm x 4, 2.7mm Evolox® Plates 4-14 Holes (11 Plates), 3.5mm Locking Screws 10-14mm x 4, 16-26mm x 5, 28-34mm x 4, 3.5mm Evolox® Plates 4-14 Holes (11 Plates), Evolox® Plate Benders, Screwdrivers x 2, Drill Bits x 2, Depth Gauge, Locking Plugs x 10, Locking Drill Guides x 2, Mesh Container, Screw/Plate Trays, Sterilisable Box.	
KIT-EVO-242735	2.4/2.7/3.5mm Evolox® Kit with Screws and 2.7/3.5mm Plates - Hex Drive
KIT-EVO-242735-TD	2.4/2.7/3.5mm Evolox® Kit with Screws and 2.7/3.5mm Plates - Star Torx Drive
Each kit comprises: 2.4mm Locking Screws 6-10mm x 3, 12-14mm x 4, 16-24mm x 5, 26-32mm x 4, 2.4mm Evolox® Cuttable Plate, 2.4mm Evolox Cuttable Malleable Plate, 2.7mm Locking Screws 6-14mm x 4, 16-20mm x 5, 22-32mm x 4, 2.7mm Evolox® Plates 4-14 Holes (11 Plates), 3.5mm Locking Screws 10-14mm x 4, 16-26mm, 28-34mm x 4, 3.5mm Evolox® Plates 4-24 Holes (11 Plates), Screwdrivers, Evolox® Plate Benders x 2, Drill Bits x 3, Depth Gauge, Screw Holding Forceps, Locking Plugs x 10, Locking Drill Guides x 3, Screw Measuring Gauge, Mesh Basket, Screw/plate Trays, Sterile Container Box.	

*Practice discounts do not apply to kits as already heavily discounted.

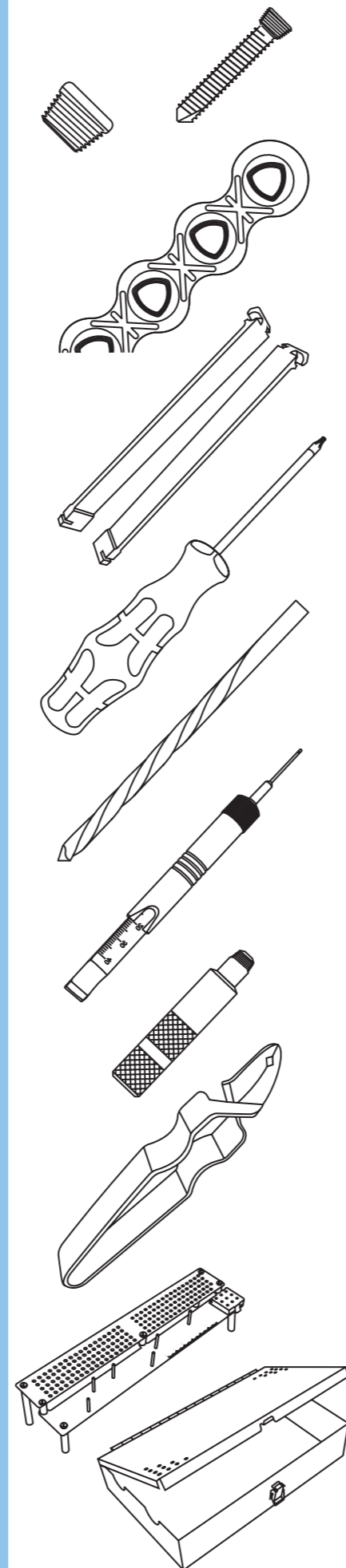

TPLO Locking Kits

Order Code	Description
KIT-TPLO	TPLO Evolox® Full Kit, One of Each Plate with Screws and Instruments in Box and Rack - Hex Drive
KIT-TPLO-TD	TPLO Evolox® Full Kit, One of Each Plate with Screws and Instruments in Box and Rack - Star Torx Drive
Each kit comprises: 2.4mm Locking Screws 10-20mm x 5, 22-32mm x 3, 2.7mm Locking Screws 12-30mm x 5, 32-40mm x 3, 3.5mm Locking Screws 14-16mm x 3, 18-30mm x 5, 32-44mm x 3, TPLO Evolox® Plates 2.4mm x 2, 2.7mm x 2, 2.7mm Long x 2, 3.5mm x 2, 3.5mm Long x 2, 3.5mm Broad x 2, Locking Drill Guides x 3, Screwdrivers x 2, Locking Plugs x 10, Plate Benders x 2, T Bar Tap Handle, Quick Release Taps x 3, Drill Bits x 5, Locking Plug Boxes x 2.	

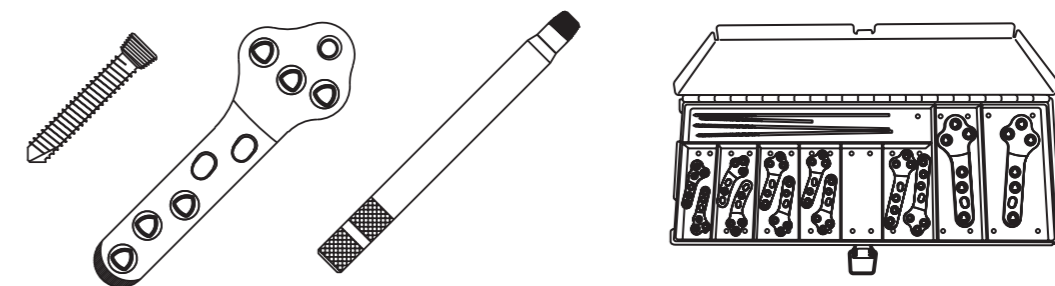

Premium TPLO Kit

As with our Evolox kits we have released a premium TPLO kit range with the same quality implants but in premium boxes that require no wrapping or bagging to sterilise. Contact us for further information or to let us know what your kit requirements are.



Suture Screw Kit

Order Code	Description
KIT-SUT-SCW	Suture Screw Starter Kit - Two of Each Screw and a Screwdriver in a Stainless Steel Box
Each kit comprises:	2.0mm Suture Screws 6-10mm x 2, 2.7mm Suture Screws 8-14mm x 2, 3.5mm Suture Screws 12-20mm x 2, 4.0mm Suture Screws 16-24mm x 2, Universal Screwdriver, Screw Tray, Storage Box.

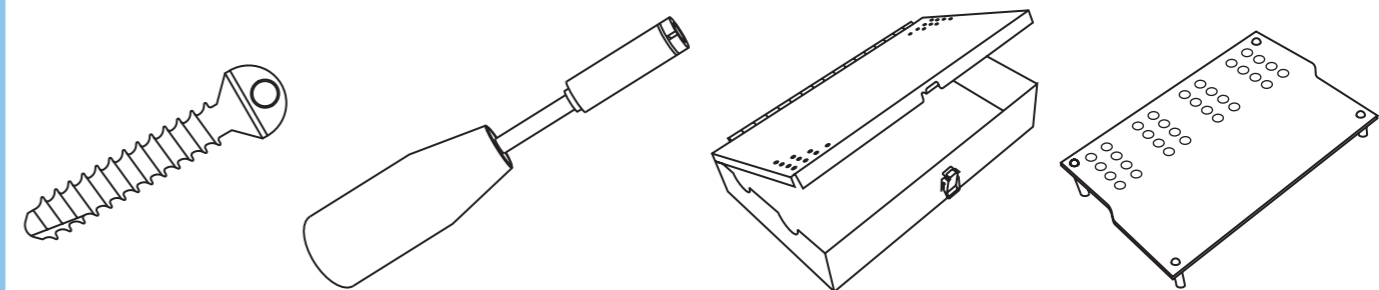

*Practice discounts do not apply to kits as already heavily discounted

For full terms and conditions please visit our website.

Spinnaker Premium TPLO Implant Kit

To complement our quality Spinnaker TPLO plate range (in our Implant catalogue) we are launching our new complete Spinnaker Premium TPLO Implant Kit.

Made of an anodised aluminium block it has been designed to fit all the implants you would need to use, any size of our Spinnaker TPLO plate range. Two of each size plate can be carried in the kit and the clear markings make it easy for it to be restocked after your procedures. For Spinnaker TPLO plates see page 164 of the implant catalogue.

Both cortical and locking screws fit side by side and are easily reachable by driver.

The lid ensures the screws are held tightly in place during storage.

The rack is designed to fit in our premium storage boxes meaning there is no wrapping needed to sterilise the kits. Once sterilised they will remain sterile for up to 12 months whilst the lid remains down meaning they are a great way to reduce your practice carbon footprint.

We offer a few kit options to suit your needs.

Order Code	Description
PM-RACK-TPLO-IMP-MP	Victory Rack Full of Screws (5 Locking and 2 Corticals) and one of each Monoaxial Proximal Hole Spinnaker Plates
PM-RACK-TPLO-IMP-PP	Victory Rack Full of Screws (5 Locking and 2 Corticals) and one of each Polyaxial Proximal Hole Spinnaker Plates

The implant kit comprises:

- Victory Premium TPLO Tray
- Premium Storage Box
- 2.0mm Cortical Torx Screws 6mm-20mm
- 2.4mm Cortical Torx Screws 8mm-28mm
- 2.7mm Cortical Torx Screws 10mm-30mm
- 3.5mm Cortical Torx Screws 14mm-36mm
- 2.0mm Locking Torx Screws 6mm-20mm
- 2.4mm Locking Torx Screws 8mm-28mm
- 2.7mm Locking Torx Screws 10mm-30mm
- 3.5mm Locking Torx Screws 14mm-36mm
- 2.0-3.5mm Locking Drill Guides
- One of Each Spinnaker TPLO Plate (L and R) 2.0, 2.4, 2.7, 3.5 Small, 3.5 and 3.5mm Broad



Spinnaker Premium Complete TPLO Kit

You can also purchase a complete kit including the instruments required in an autoclavable box.

Order Code	Description
PM-KIT-TPLO-MP-FULL	Victory Complete Kit with Instruments and Storage Box with Spinnaker Monoaxial Proximal Hole Plates
PM-KIT-TPLO-PP-FULL	Victory Complete Kit with Instruments and Storage Box with Spinnaker Polyaxial Proximal Hole Plates

The complete kit offers everything listed on previous page, plus:

- Premium Storage Box
- Premium AO Handle
- Screwdriver Tips for T6, T8 and T15 Screws
- Drill Bits 1.8, 2.0, 2.5 and 2.7mm
- Load/Neutral Drill Guides 2.0, 2.4, 2.7 and 3.5mm



IOHC HIF KIT

Victory Premium Range

Due to the popularity of our IOHC screws we have created a couple of kits to suit all needs and budgets; the Victory premium set comes in the black rack and is designed to fit into the premium boxes we sell. There is space in the kit to add additional products. For IOHC screws see page 32 of the implant catalogue.

Order Code	Description
PM-RACK-IOHC	Premium Victory HIF Screw Rack
PM-RACK-IOHC-FULL-TD	Premium HIF Screw Rack Fully Loaded with Torx Screws
IN-BASK-HF	Storage Basket for HF Kit with Hinged Lid (Outside Diameter 75mm x 175mm x 40mm)
JG285R	Premium Tray with Lid 273 x 176 x 60mm
JN095	Premium Sterile Box (Outside Diameter 313 x 190 x 92mm)
AC-FILTER-JK091	Pack of 2 Reuseable Filters for the above Box

Kit includes:

Order Code	Description	Qty
PM-RACK-IOHC	Victory Premium Screw Rack	1
IOHC-45-26-TD	4.5mm IOHC Screw 26mm – Torx Drive	2
IOHC-45-28-TD	4.5mm IOHC Screw 28mm – Torx Drive	2
IOHC-45-30-TD	4.5mm IOHC Screw 30mm – Torx Drive	2
IOHC-45-32-TD	4.5mm IOHC Screw 32mm – Torx Drive	2
IOHC-45-34-TD	4.5mm IOHC Screw 34mm – Torx Drive	2
IOHC-45-36-TD	4.5mm IOHC Screw 36mm – Torx Drive	2
IOHC-45-38-TD	4.5mm IOHC Screw 38mm – Torx Drive	2
IOHC-45-40-TD	4.5mm IOHC Screw 40mm – Torx Drive	2
COR-ST-4526-TD	4.5mm Cortical Self Tapping Screw 26mm – Torx Drive	2
COR-ST-4528-TD	4.5mm Cortical Self Tapping Screw 28mm – Torx Drive	2
COR-ST-4530-TD	4.5mm Cortical Self Tapping Screw 30mm – Torx Drive	2
COR-ST-4532-TD	4.5mm Cortical Self Tapping Screw 32mm – Torx Drive	2
COR-ST-4534-TD	4.5mm Cortical Self Tapping Screw 34mm – Torx Drive	2
COR-ST-4536-TD	4.5mm Cortical Self Tapping Screw 36mm – Torx Drive	2
COR-ST-4538-TD	4.5mm Cortical Self Tapping Screw 38mm – Torx Drive	2
COR-ST-4540-TD	4.5mm Cortical Self Tapping Screw 40mm – Torx Drive	2
COR-ST-4542-TD	4.5mm Cortical Self Tapping Screw 42mm – Torx Drive	2
COR-ST-4544-TD	4.5mm Cortical Self Tapping Screw 44mm – Torx Drive	2

The kits have been designed in conjunction with Dr Ben Garland BVetMed CertAVP(GSAS) MRCVS RCVS Advanced Practitioner in Small Animal Surgery.

Director: DVSR - Debenham Vets Surgical Referrals Ltd.



Standard HIF Kit

For the more budget conscious we also have a standard range, which uses the same quality implants but uses standard boxes and rack that require wrapping to sterilise.

Order Code	Description
KIT-IOHC-STD-FULL-TD	Full HIF Kit and Instruments in a Box with Torx Head IOHC Screws

Kit includes:

Order Code	Description	Qty
COR-ST-4512-TD	Cortical Bone Screw 4.5mm x 12mm Self Tapping - T15 Torx Drive	2
COR-ST-4514-TD	Cortical Bone Screw 4.5mm x 14mm Self Tapping - T15 Torx Drive	2
COR-ST-4516-TD	Cortical Bone Screw 4.5mm x 16mm Self Tapping - T15 Torx Drive	2
COR-ST-4518-TD	Cortical Bone Screw 4.5mm x 18mm Self Tapping - T15 Torx Drive	2
COR-ST-4520-TD	Cortical Bone Screw 4.5mm x 20mm Self Tapping - T15 Torx Drive	2
COR-ST-4522-TD	Cortical Bone Screw 4.5mm x 22mm Self Tapping - T15 Torx Drive	2
COR-ST-4524-TD	Cortical Bone Screw 4.5mm x 24mm Self Tapping - T15 Torx Drive	2
COR-ST-4526-TD	Cortical Bone Screw 4.5mm x 26mm Self Tapping - T15 Torx Drive	2
COR-ST-4528-TD	Cortical Bone Screw 4.5mm x 28mm Self Tapping - T15 Torx Drive	2
COR-ST-4530-TD	Cortical Bone Screw 4.5mm x 30mm Self Tapping - T15 Torx Drive	2
COR-ST-4532-TD	Cortical Bone Screw 4.5mm x 32mm Self Tapping - T15 Torx Drive	2
COR-ST-4534-TD	Cortical Bone Screw 4.5mm x 34mm Self Tapping - T15 Torx Drive	2
COR-ST-4536-TD	Cortical Bone Screw 4.5mm x 36mm Self Tapping - T15 Torx Drive	2
COR-ST-4538-TD	Cortical Bone Screw 4.5mm x 38mm Self Tapping - T15 Torx Drive	2
COR-ST-4540-TD	Cortical Bone Screw 4.5mm x 40mm Self Tapping - T15 Torx Drive	2
CS-35-T	T Handle Countersink for 3.5mm Screws	1
CS-QR-HIF	AO Quick Release Chamfer Tool for N2 Style 4.5mm IOHC Screws with a 3.2 Pilot Hole	1
DE-GA-4565	Depth Gauge for 4.5/6.5mm Screw	1
DRL-32-170	Standard Economy Drill Bit 3.2mmØ 170mm Long	1
DRL-CAN-32-130	Drill Bit 3.2mmØ with 1.1mm Cannulation 130mm Long	2
IOHC-45-24-TD	IOHC (Incomplete Ossification of the Humeral Condyle) Screw L24mm - Torx Drive	2
IOHC-45-26-TD	IOHC (Incomplete Ossification of the Humeral Condyle) Screw L26mm - Torx Drive	2
IOHC-45-28-TD	IOHC (Incomplete Ossification of the Humeral Condyle) Screw L28mm - Torx Drive	2
IOHC-45-30-TD	IOHC (Incomplete Ossification of the Humeral Condyle) Screw L30mm - Torx Drive	2
IOHC-45-32-TD	IOHC (Incomplete Ossification of the Humeral Condyle) Screw L32mm - Torx Drive	2
IOHC-45-34-TD	IOHC (Incomplete Ossification of the Humeral Condyle) Screw L34mm - Torx Drive	2
IOHC-45-36-TD	IOHC (Incomplete Ossification of the Humeral Condyle) Screw L36mm - Torx Drive	2
IOHC-45-38-TD	IOHC (Incomplete Ossification of the Humeral Condyle) Screw L38mm - Torx Drive	2
IOHC-45-40-TD	IOHC (Incomplete Ossification of the Humeral Condyle) Screw L40mm - Torx Drive	2
KIT-RACK-BOX	Kit Box to Fit 3 Screw Racks (SW RACKS) and a Storage Tray	1
KIT-TRAY-GEN	General Storage Tray for Screw Rack Box	1
SD-TD-T15	Screwdriver for 3.5mm Star (Torx) Drive	1
SW-RACK-45	Screw Rack for 4.5mm Screws with Lid	1
SW-RACK-IOHC	IOHC Screw Rack	1



Stainless Steel Boxes

Order Code	Description
KIT-BOX-1	Stainless Steel Box fits 1 Cortical Insert L x 155mm, W x 143mm, D x 63mm
KIT-BOX-2	Stainless Steel Box fits 2 Cortical or 2 Locking Inserts L x 255mm, W x 155mm, D x 60mm. This includes hinges and clips
KIT-BOX-3	Stainless Steel Box fits 2 Cortical or 2 Locking Inserts L x 255mm, W x 155mm, D x 60mm

A good sized box for instruments. Add the 2.4/2.7/3.5mm screw rack and the most popular screw sizes can all be stored together ready to use. There is also an additional tray that can fit on top of the screw rack, designed to fit TPLO plates. It's also a useful general storage tray.

Order Code	Description
KIT-BOX-TPLO	Stainless Steel Box L x 280mm, W x 110mm, D x 75mm
KIT-TRAY-TPLO	TPLO Box Insert
SW-RACK-242735	Screw Rack for 2.4mm/2.7mm/3.5mm Screws

Cortical Kit Inserts

Fit in KIT-BOX-1 or two fit in KIT-BOX-2 and KIT-BOX-3

Order Code	Description
KIT-INS-CORT-1520	Stainless Steel Insert to Fit 1.5/2.0mm Cortical Screws and Plates
KIT-INS-CORT-24	Stainless Steel Insert to Fit 2.4mm Cortical Screws and Plates
KIT-INS-CORT-27	Stainless Steel Insert to Fit 2.7mm Cortical Screws and Plates
KIT-INS-CORT-35	Stainless Steel Insert to Fit 3.5mm Cortical Screws and Plates

Suture Screw Kit Insert

Order Code	Description
KIT-INS-SUT	Screw Rack for Suture Anchor Screws

External Fixation Storage Box

To contain all your kit together we have created this basic storage unit which comprises of outer box, lower tray for instruments and larger bars, and upper partitioned tray for clamps, pins and smaller bars.

Order Code	Description
KIT-BOX-EX-FIX	Kit Box and 2 Trays for External Fixation Kits
KIT-BOX-EX-FIX-3	Kit Box and 3 Trays for External Fixation Kits
KIT-BOX-3	Stainless Box 250 x 150 x 60mm
KIT-TRAY-EMPTY	Tray Only Without Partitions (Fits in KIT-BOX-3)
KIT-TRAY-PART	Tray With Partitions (Fits in KIT-BOX-3)

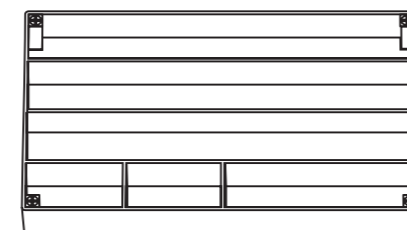
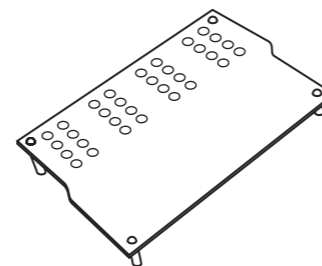
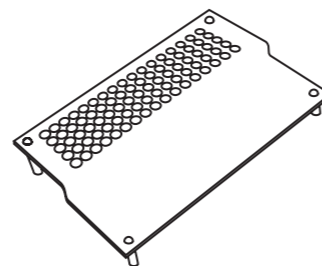
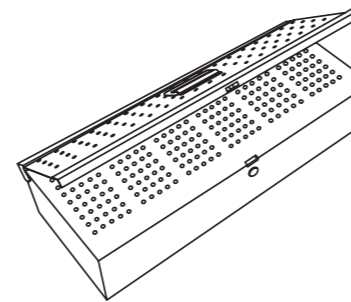
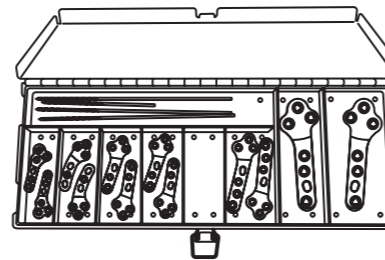
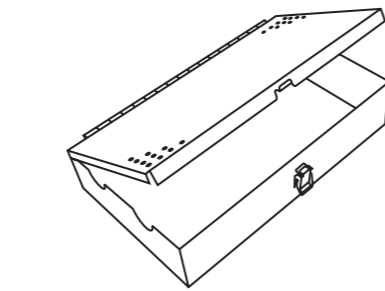

Kit Boxes

Order Code	Description
KIT-BOX-MED	Medium Stainless Steel Storage Box 270 x 200 x 90mm
KIT-BOX-LARGE	Large Stainless Steel Storage Box 370 x 220 x 100mm

Locking Kit Inserts

Order Code	Description
KIT-INS-LOC-24	Stainless Steel Insert to Fit 2.4mm Locking Screws and Plates
KIT-INS-LOC-27	Stainless Steel Insert to Fit 2.7mm Locking Screws and Plates
KIT-INS-LOC-35	Stainless Steel Insert to Fit 3.5mm Locking Screws and Plates
KIT-INS-EVO-2427	Stainless Steel Insert to Fit 2.4 and 2.7mm Locking Screws and 2.7mm Evolox® Plates
KIT-INS-EVO-35	Stainless Steel Insert to Fit 3.5mm Locking Screws and Evolox® Plates

Two fit in KIT-BOX-2 and KIT-BOX-3

Wire/Pin Storage

Large tubes divided into 4 marked compartments. The end of the tube rotates and when lined up with the corresponding section allows them to drop through for use. Fits standard 125mm length wires.

Order Code	Description
SD-W-SM	Small Wire Storage/Dispenser 0.9mm/1.1mm/1.25mm/1.4mm
SD-W-LG	Large Wire Storage/Dispenser 1.5mm/1.6mm/1.8mm/2.0mm
SD-W-SET	One of each of the above storage tubes

As above but fits 300mm steinman bone pins.

Order Code	Description
SD-ST-SM	Steinman Bone Pin Dispenser 1.6/2.0/2.4/2.8mm
SD-ST-LG	Steinman Bone Pin Dispenser 3.2/3.6/4.0/4.8mm

Basic storage tubes in different lengths. Perforated sides allow pins/wires to be sterilised in the tube for ease and safety.

Order Code	Description
ST-S-135	Storage Tube 10mm Diameter 135mm
ST-L-170	Storage Tube 18mm Diameter 170mm
ST-S-180	Storage Tube 10mm Diameter 180mm
ST-L-200	Storage Tube 20mm Diameter 195mm

Small storage box ideal for holding locking plugs in your kits.

Order Code	Description
LOC-PLUG-BOX	Small Box for Holding Locking Plugs 30mm x 16mm

For locking plugs see page 17 of the implant catalogue.

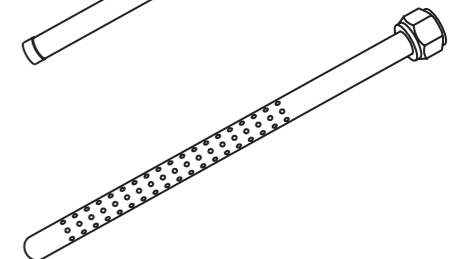
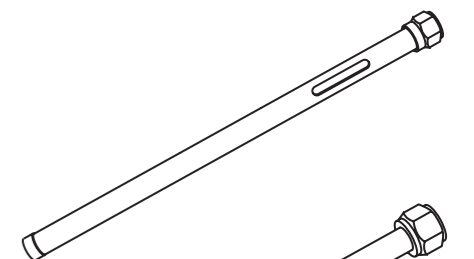
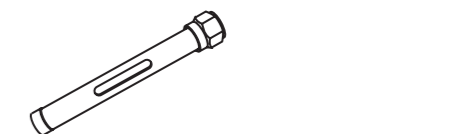
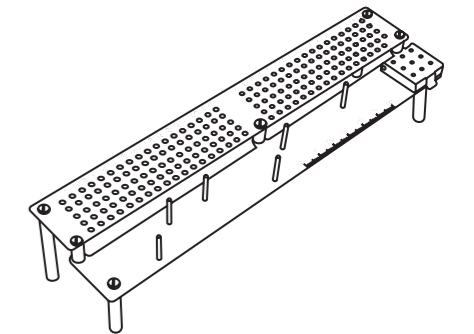
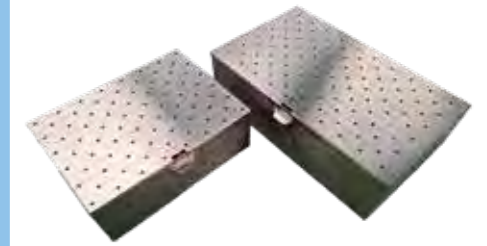



Screw Racks (Empty)

Stand alone screw racks (won't fit in modular system) with a hinged lid.

Order Code	Description
SW-RACK-1520	Screw Rack for 1.5/2.0mm Screws with Lid
SW-RACK-20	Screw Rack for 2.0mm Screws with Lid
SW-RACK-24	Screw Rack for 2.4mm Screws with Lid
SW-RACK-27	Screw Rack for 2.7mm Screws with Lid
SW-RACK-35	Screw Rack for 3.5mm Screws with Lid
SW-RACK-45	Screw Rack for 4.5mm Screws with Lid
SW-RACK-55	Screw Rack for 5.5mm Screws with Lid

We now offer a box that fits any three of the above racks allowing you to tailor the kit according to what you might need; you could have a selection of cortical screws or locking screws or a hybrid selection of both. You could also consider adding KIT-TRAY-GEN to your box as well, giving you space for additional items such as drill bits, screwdrivers or even a few plates.

Order Code	Description
SW-RACK-202427	Screw Rack for 2.0/2.4/2.7mm Screws with Lid
SW-RACK-242735	Screw Rack for 2.4/2.7/3.5mm Screws with Lid
SW-RACK-20242735	Complete Screw Rack for 2.0/2.4/2.7/3.5mm Locking and Cortical Screws with Lid

Order Code	Description
ST-RACK-1520	Standard Screw Rack for 1.5/2.0mm Screws
ST-RACK-20	Standard Screw Rack for 2.0mm Screws
ST-RACK-24	Standard Screw Rack for 2.4mm Screws
ST-RACK-27	Standard Screw Rack for 2.7mm Screws
ST-RACK-35	Standard Screw Rack for 3.5mm Screws

Order Code	Description
ST-RACK-20-CL	2.0mm Combination Screw Racks for Cortical and Locking Screws
ST-RACK-24-CL	2.4mm Combination Screw Racks for Cortical and Locking Screws
ST-RACK-27-CL	2.7mm Combination Screw Racks for Cortical and Locking Screws
ST-RACK-35-CL	3.5mm Combination Screw Racks for Cortical and Locking Screws
ST-RACK-242735	Standard Screw Rack for 2.4/2.7/3.5mm Screws. Ideal for TPLO Cortical Screws (7)

Ideal for TPLO Cortical Screws (7)

Order Code	Description
NEEDLE-BOX	Needle Box Stainless Steel - Length: 67mm x Width: 45mm x Depth: 7.5mm

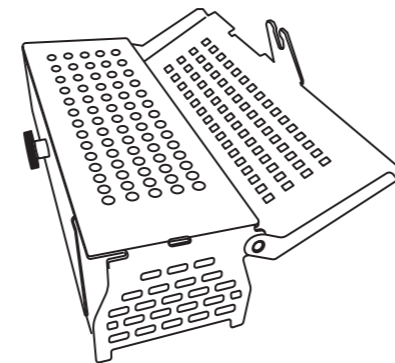
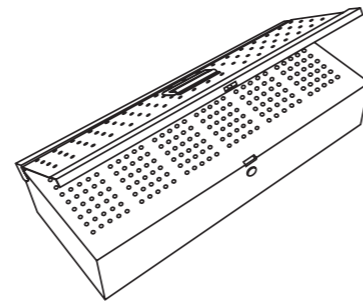
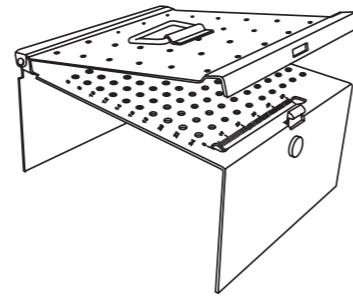

Screw Rack Storage

Stand alone screw racks (won't fit in modular system) with a hinged lid.

Order Code	Description
KIT-RACK-BOX	Storage box designed to fit any three SW-RACKs
KIT-TRAY-GEN	Designed to fit on top of SW-RACK's in the box allowing additional items to be stored and sterilised together

Mini Screw Racks

Designed to fit in your current locking kits, the mini screw racks contain room for the cortical screw sizes you might need for locking TPLO plates and are small enough to fit in your current kits.

Order Code	Description
SW-RACK-MINI-24	Mini Screw Rack for 2.4mm Screws with Lid
SW-RACK-MINI-27	Mini Screw Rack for 2.7mm Screws with Lid
SW-RACK-MINI-35	Mini Screw Rack for 3.5mm Screws with Lid

Drill Storage Box

Marked to hold the following drill bits

1.1, 1.5, 1.8, 2.0, 2.4, 2.5, 2.7, 3.2, 3.5, 4.0, 4.5

Order Code	Description
DR-BOX	Drill Box Empty
DR-BOX-FULL	Drill Box Complete with 1.1, 1.5, 1.8, 2.0, 2.4, 2.5, 2.7, 3.2, 3.5, 4.0, 4.5mm Drills

For drill bits see page 56.

Wire Storage Box

Designed to take 6 or 12 sizes of Kirschner wire 125mm as well as a k-wire bender and a pin punch.

Order Code	Description
KW-BOX-6	Kirschner Wire Box 6 Sizes
KW-BOX-12	Kirschner Wire Box 12 Sizes

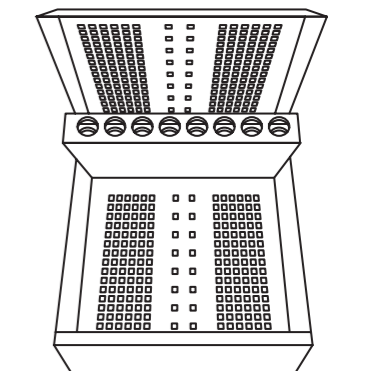
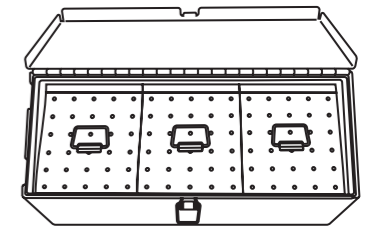

Bone Pin Roll

Autoclavable IM pin bag that allows IM pin organization in a neat and easy-to-find fashion. For IM pins see page 48 of the implant catalogue.

The fold over lid ensures pins do not penetrate your sterilisation bags.

Order Code	Description
BP-SW-UNI	Autoclavable Pin Storage Bag



Matting

Both instruments and implants need looking after. We have created a selection of silicone matting that fit into our most common boxes and baskets to help protect your metal work. They all come with long fingers to help grab your instruments and hold them in place.

Order Code	Description
MAT-KIT-180295	Silicone Insert 180mm x 295mm
MAT-KIT-BOX-1	Silicone Insert for KIT BOX 1 148mm x 128mm
MAT-KIT-BOX-2	Silicone Insert for KIT BOX 2 248mm x 148mm
MAT-KIT-BOX-TPLO	Silicone Insert for KIT BOX TPLO 273mm x 105mm
MAT-KIT-PRM-BKT	Silicone Insert for Premium Box 265mm x 165mm
MAT-KIT-RACK-BOX	Silicone Insert for KIT RACK BOX 278mm x 118mm
MAT-KIT-STOR	Silicone Mat to fit IN BASK 46 & IN BASK 23

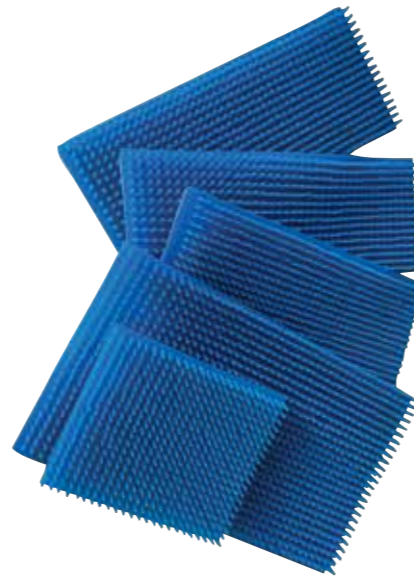

Suction Tips

A selection of common suction tips covering most requirements.

Order Code	Description
SUC-TIP-AD-40-210	Adson Suction Tip 4.0mm 210mm Long
SUC-TIP-FZ-27-190	Frazier Suction Tip 2.7mm 190mm Long
SUC-TIP-FZ-33-190	Frazier Suction Tip 3.3mm 190mm Long
SUC-TIP-FZ-40-190	Frazier Suction Tip 4.0mm 190mm Long
SUC-TIP-PL-80-200	Poole Suction Tip 8.0mm 200mm Long
SUC-TIP-YK-65-255	Yankauer Suction Tip 6.5mm 255mm Long



External Fixation Kits

Order Code	Description
KIT-KE+-BASIC	KE+ Kit (8 of Each Single Clamps Plus Bars and Instruments) in Box
Each kit comprises:	KE+ Clamps Single x 8 of each size, Small Connecting Bars 2 x 30mm, 2 x 150mm, Medium Connecting Bars 2 x 75mm, 2 x 200mm, Large Connecting Bars 2 x 100mm, 2 x 240mm, Soft Tissue Protector, Spanners x 3, Kit Box and Storage Tray.

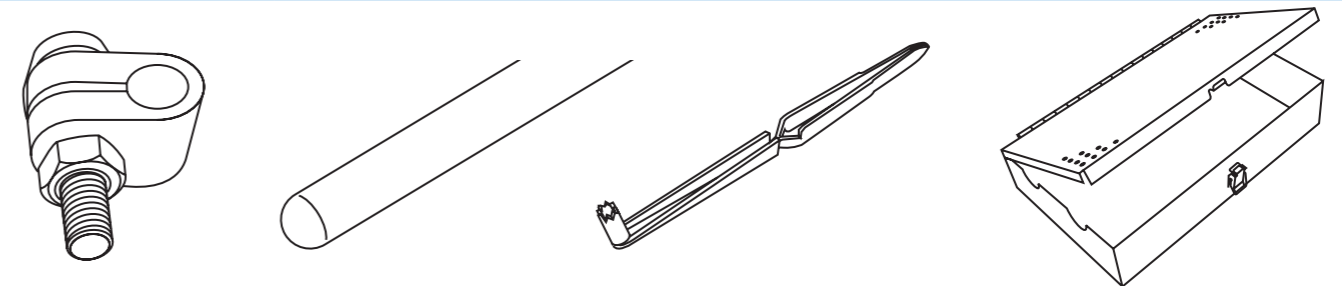

Order Code	Description
KIT-KE+-FULL	KE+ Kit (8 of Each Single Clamps and 2 of Each Double Plus Bars and Instruments) in Box
Each kit comprises:	KE+ Clamps Single x 8 of each size, KE+ Clamps Double x 2 of each size, Small Connecting Bars 2 x 30mm, 2 x 100mm, Medium Connecting Bars 2 x 75mm, 2 x 200mm, Large Connecting Bars 2 x 100mm, 2 x 240mm, Soft Tissue Protector, Spanners x 3, Kit Box and Storage Tray.

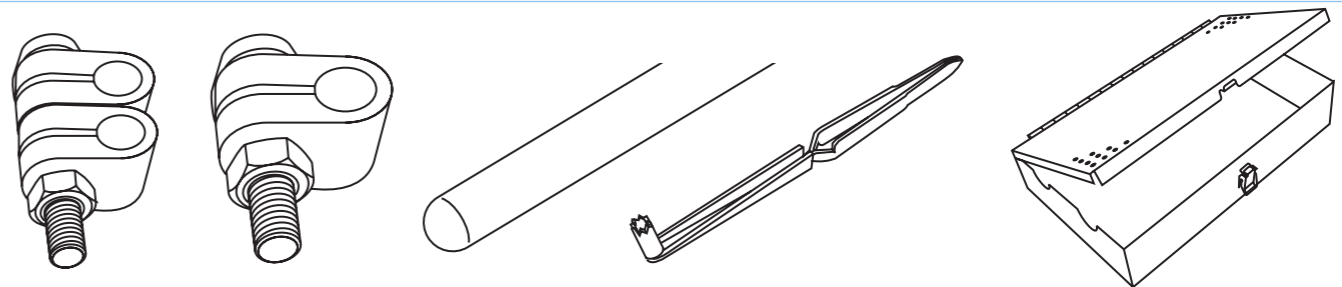

Order Code	Description
KIT-SF-BASIC	SF Kit (8 of Each Single Clamps Plus Bars and Instruments) in Box
Each kit comprises:	SF Clamps Single x 8 of each size, Mini Connecting Bars Stainless Steel 2 x 30mm, 2 x 100mm, Small Connecting Bars Titanium 2 x 100mm, 2 x 200mm, Large Connecting Bars 2 x 100mm, 2 x 250mm, Soft Tissue Protector, Spanners x 3, Kit Box and Storage Tray.

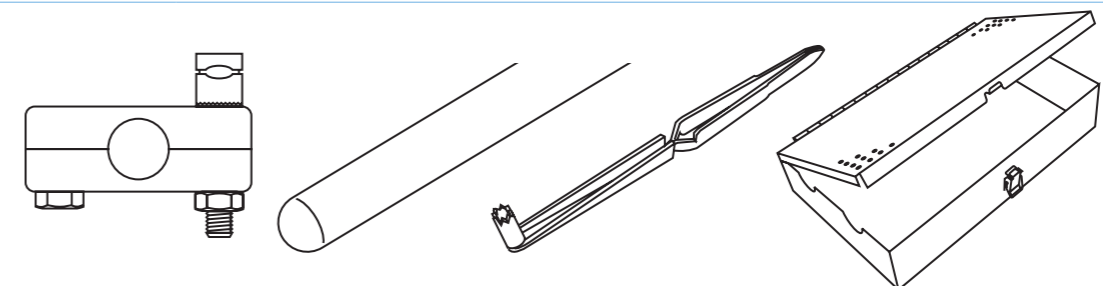

External Fixation Kits cont.

Order Code	Description
KIT-SF-FULL	SF Kit (8 of Each Single Clamps and 2 of Each Double Plus Bars and Instruments) in Box
Each kit comprises:	SF Clamps Single x 8 of Each Size, Mini Connecting Bars Stainless Steel, 2 x 30mm, 2 x 100mm, Small Connecting Bars Titanium 2 x 100mm, 2 x 200mm, Large Connecting Bars Aluminium 2 x 100mm, 2 x 250mm, Soft Tissue Protector, Spanners x 3, Kit Box and Storage Tray.

Order Code	Description
KIT-SF-BASIC-C	SF Kit (8 of Each Single Clamps Plus Small and Large Carbon Bars and Instruments) in Box
Each kit comprises:	SF Clamps Single x 8 of Each Size, Mini Connecting Bars Stainless Steel 2 x 30mm, 2 x 100mm, Small Connecting Bars Carbon Fibre, 2 x 100mm, 2 x 200mm, Large Connecting Bars Carbon Fibre, 2 x 100mm, 2 x 250mm, Soft Tissue Protector, Spanners x 3, Kit Box and Storage Tray.

Order Code	Description
KIT-SF-FULL-C	SF Kit (8 of Each Single Clamps Plus 2 of Each Double Plus Small and Large Carbon Bars and Instruments) in Box
Each kit comprises:	SF Clamps Single x 8 of Each Size, SF Clamps Double x 2 of Each Size, Mini Connecting Bars Stainless Steel 2 x 30mm, 2 x 100mm, Small Connecting Bars Carbon Fibre 2 x 100mm, 2 x 200mm, Large Connecting Bars Carbon Fibre, 2 x 100mm, 2 x 250mm, Soft Tissue Protector, Spanners x 3, Kit Box and Storage Tray.

General Surgery Kits

Order Code	Description
CS-KIT	Canine Spay Kit - Complete in Box
Each kit comprises:	Spencer Wells Artery Forceps Straight and Curved 120mm, Spencer Wells Artery Forceps Curved 150mm, Carmalt Forceps Curved 160mm and 200mm, Spay Forceps, Mayo Scissors Straight and Curved 140mm, Allis Tissue Forceps 150mm ¼ Teeth x 2, Olsen Hegar Needle Holders T.C. 140mm, Rat Tooth Forceps 140mm, Towel Clips Jones 90mm x 4, Scalpel Handle, Sterilisable Box.
FS-KIT	Feline Spay Kit - Complete in Box
Each kit comprises:	Spencer Wells Artery Forceps Curved 120mm x 2, Dissecting Forceps Adson ½ Teeth 120mm, Halstead Mosquito Forceps 120mm x 2, Metzenbaum Scissors Straight 140mm, Olsen Hegar Needle Holders T.C. 140mm, Spay Forceps 120mm, Towel Clips Jones 90mm x 4, Scalpel Handle, Sterilisable Box.

Dental Surgery Kits

Feline and Canine Dental kits containing the basic instruments required, the kits come in a stainless steel box and are heavily discounted against buying individually.

Order Code	Description
DENTAL-CAT	Feline Dental Kit
Each kit comprises:	Winged Elevator Set 1mm-4mm, Dental Extraction Forceps Small, Tartar Forceps Small, Periosteal Elevator Small, Explorer Probe, Subgingival Curette, Supragingival Curette.
DENTAL-DOG	Canine Dental Kit
Each kit comprises:	Winged Elevator Set 1mm-4mm, Dental Extraction Forceps Large, Tartar Forceps Large, Periosteal Elevator Large, Explorer Probe, Subgingival Curette, Supragingival Curette.

Ophthalmic Kit

We have created a basic kit containing the most useful items for most common ophthalmic procedures offering a good range of instruments and value. A must for all practices to cover the basic ophthalmic needs.

Order Code	Description
OP-KIT-STD	Basic Ophthalmic Kit
Each kit comprises:	Halstead Mosquito Forceps 100mm Curved x 1, Halstead Mosquito Forceps 100mm Straight x 1, Barraquer Wire Eyelid Speculum 30mm Gape 10mm Blade x 1, St Martins Corneal Forceps 90mm x 1, Graefe Fixation Forceps 105mm x 1, Iris Forceps 1/2 Teeth 100mm x 1, Roberts Tying Forceps 100mm x 1, Castroviejo Needle Holder with Scissor Straight T.C. 150mm x 1, Stevens Tenotomy Scissors Curved 110mm x 1, Stevens Tenotomy Scissors Straight 110 x 1, Beaver Blade Handle 130mm x 1, Jones Towel Clips 90mm x 2, Stainless Steel Autoclavable Box x 1, Autoclavable Storage Box and Silicone Mat.

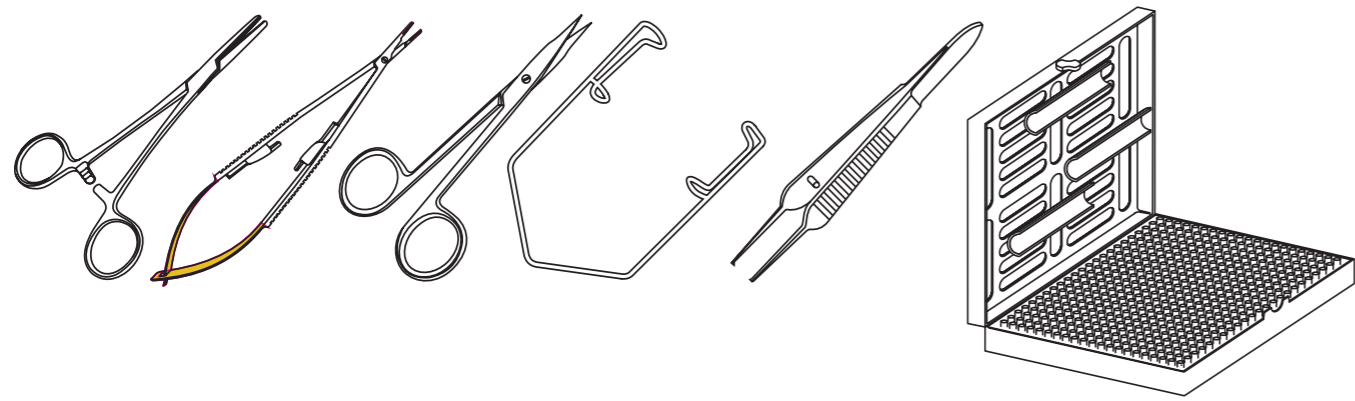

Standard Screws, Locking Screws, Drill Bits and Taps

Thread Diameter	Screw Diameter (mm)										Screw Type	Locking Head	Sherman		
	1.5	2.0	2.4	2.7	3.5	4.5	5.5	3.0	4.0	4.0					
Drill Bit for Gliding Hole															
Drill Bit for Pilot hole															
Tap															
Drive Type	1.5mm Hex	1.5mm Hex Cruciate Slot Re- cess	1.5mm Hex 2.0 Hex 2.0 Hex Cruciate Recess	2.0 Hex Cruciate T8/T15	2.5mm Hex Cruciate Recess T8/T15	3.5mm Hex	2.5mm Hex	2.5mm Hex	2.0 Hex	2.5mm Hex	2.0 Hex	2.5mm Hex	2.0 Hex	2.5mm Hex T15	2.5mm Hex T8



Procedure for Care and Maintenance of Stainless Steel Medical Instruments

Objective:

To ensure the proper cleaning, sterilisation, and maintenance of stainless steel medical instruments, thereby extending their lifespan, maintaining functionality, and ensuring patient safety.

1. General Guidelines

- **Avoid rough handling:** Handle instruments with care to prevent damage to the delicate tips and edges.
- **Separation:** Instruments with sharp tips or cutting edges should be separated from other instruments to avoid damage during cleaning and sterilisation.
- **Regular inspection:** Visually inspect instruments for any signs of damage, corrosion, or wear, especially at hinges, locks, or sharp edges.

2. Cleaning and Decontamination

2a. Pre-Cleaning

- **Immediate Rinse:** Immediately after use, rinse instruments under warm water to remove any blood, tissue, or debris. Use a soft-bristled brush or cloth to remove any visible contaminants.
- **Avoid Prolonged Soaking:** Do not leave instruments soaking for long periods, especially in saline or other corrosive solutions, as this can lead to rusting.
- **Segregation of Instruments:** Segregate delicate instruments from heavier ones to avoid physical damage.

2b. Manual Cleaning

- **Equipment:** Use soft brushes, sponges, or cloths. Avoid using metal brushes or abrasive materials that could scratch the stainless steel surface.
- **Detergents:** Use a pH-neutral or mild enzymatic detergent solution. Avoid harsh chemicals like bleach or chloride-based cleaners, as they can cause corrosion.
- **Cleaning Technique:**
 1. Immerse the instruments in the detergent solution.
 2. Gently scrub the instruments, focusing on joints, hinges, and serrations where debris can accumulate.
 3. Rinse thoroughly with deionized or distilled water to prevent residue build-up from tap water minerals.

2c. Ultrasonic Cleaning

- **Preparation:** Place instruments in an open position in the ultrasonic cleaner, ensuring that they do not overlap to ensure proper cleaning.
- **Cleaning Time:** Run the ultrasonic cleaner for the manufacturer's recommended time (typically 5-10 minutes).
- **Rinse:** After cleaning, rinse the instruments in deionized water.

3. Drying

- **Immediate Drying:** Instruments must be dried immediately after rinsing to prevent water spots or corrosion. Use a lint-free cloth or compressed air for drying, especially around joints and hinges.
- **Avoid Air-drying:** Do not allow instruments to air-dry as this can lead to staining or corrosion.

4. Inspection

- After cleaning, visually inspect instruments for any signs of:
 - Damage (e.g., dullness, cracks, or bends).
 - Corrosion or discoloration.
 - Proper alignment and functioning of moving parts (e.g., scissors, forceps).
- Set aside any damaged instruments for repair or replacement.



Procedure for Care and Maintenance of Stainless Steel Medical Instruments cont.

5. Lubrication

- **Lubricate Moving Parts:** Apply a medical-grade, water-soluble instrument lubricant (often called "instrument milk") to the hinges and joints of instruments. This will reduce friction and protect against corrosion.
- **Procedure:**
 1. Dip the instruments in the lubricant solution or spray the lubricant on moving parts.
 2. Allow excess lubricant to drip off, but do not rinse afterward.

6. Sterilisation

6a. Packaging

- **Proper Arrangement:** Place instruments in sterilisation pouches or trays without overcrowding. Keep hinged instruments in the open position.
- **Use Appropriate Materials:** Always use sterilisation wraps, pouches, or containers that are compatible with your sterilisation method (e.g., autoclave or dry heat).
- Be careful when handling instruments that may be hot.

6b. Autoclaving

- **Sterilisation Cycle:** Follow manufacturer guidelines for sterilisation cycles. Common sterilisation parameters include:
 - 121°C (250°F) for 30 minutes for gravity displacement autoclaving
 - 132°C (270°F) for 4-7 minutes for pre-vacuum autoclaving
- **Ensure Proper Drying:** Make sure the autoclave completes its drying cycle to avoid moisture retention, which can lead to corrosion.

6c. Dry Heat Sterilisation

- Instruments must be dry before this procedure to avoid water spots or staining.
- Ensure instruments are compatible with dry heat if using this method, typically set between 160–180°C for 30 minutes to an hour.

7. Storage

- **Store in a Dry Environment:** After sterilisation, store instruments in a clean, dry, and temperature-controlled environment to prevent corrosion and maintain sterility.
- **Avoid Humid Areas:** Ensure storage areas are free from excessive moisture, which can lead to rusting.
- **Periodic Re-sterilisation:** Instruments that have been stored for extended periods should be re-sterilized before use.

8. Rust Prevention

- **Conditions:** All Stainless Steel is vulnerable to corrosion if the conditions allow.
- **Preventative Measures:** Avoid prolonged exposure to saline solutions. Salt can cause pitting and corrosion in stainless steel. Instruments exposed to saline should be rinsed thoroughly.
- **Minimize Prolonged Exposure to Chemicals:** Strong disinfectants, bleach, and other harsh chemicals should not come into direct or prolonged contact with instruments.
- **Lubrication:** Apply a medical-grade, water-soluble instrument lubricant to provide a protective layer.

9. Rust and Stain Removal

- If any rust spots appear, remove them immediately using non-abrasive cleaners or specialized stain removers.
- **Polishing (if necessary):** Gently polish the stainless steel surface with a non-abrasive cloth or soft pad. Regular polishing can help maintain the corrosion-resistant properties of stainless steel.



Index

Adjustable Drill Guide	32	Cage Forceps	14	Drill Bits Anti Skid	57	Forceps - Rodent Molar	95
Adjustable Saw	20	Cannulated Drill Bits	58	Drill Bits Evodurance®	57	Forceps - Spencer Wells	74
Adson Forceps	74	Carmalt Forceps	80	Drill Guide - Self Centring	33	Forceps - Tartar	94
Allis Tissue Forceps	75	Carnivore Elevator	91	Drill Guide Adjustable	32	Forceps - Tissue	75
Angiotribe	80	Caspar Modular Retractor	46	Drill Guide Load/Neutral	32	Forceps - Treves	74
Angled Hohman	25	Castroviejo Needle Holder	72,99	Drill Stop Set	57	Forceps- Corneal	98
Anti Skid Drill Bits	57	Cerclage Button	47	Drill Storage Box	58,123	Forceps -Fragment	37
Artery Forceps	73	Cerclage Wire	48	E-Fiber	7	Forceps Halstead Toothed	19
Arthroplasty Rasp	20	Chuck and Handle	45	E-Fiber UHMWPE	7	Fragment Forceps	37
Arthroscopic Banana Set	50,51,52,53	Clamp - Bowel	89	Elevator - Carnivore	91	Freer Elevator	42
Arthroscopic Biopsy Set	50,51,52,54	Clamp - Ikuta	40	Elevator - Periosteal	42	Gelpi Retractor	17,25,79
Arthroscopic Curette	50,51,52,55	Clamp - Soft Palate	80	Elevator - Winged	91	Gigli Saw Handle	21
Arthroscopic Grasping Forceps	50,51,81	Clamps -Kirschner Ehmer	62	Elevators - Dental	91,92	Gillies Needle Holders	71,87
Arthroscopic Probe	50,51,52,56	Clamps- Standard Fixation	65	Endotracheal Tube Holder	80	Gosset Retractor	46
Arthroscopic Set	52,53	Coloured Scissors	78	Evodurance® Drill Bits	57	Gouge	23
Arthroscopic Stifle Lever	50,51,52,57	Combinatin Drill/Tap	33	Evolox Kit - Premium	110	Graft Passer	9
Arthroscopic Trochar Set	50,51,52,58	Cortical Kit Screw Racks	120	Evolox Kits	113,114	Grasping Forceps	50,51,81
Atraumatic Towel Clamp	80,84	Cortical Kits	111	Evolox® Plate Benders	35	Grays Mouth Gag	90
Babcock Forceps	75	Cortical Nut	48	EX Fix Kit Box	68	Halstead Mosquito Forceps	19,73,86
Backhaus Towel Clamp	84	Countersink	34	Ex Fix Kits	125,126	Hard Back Saw	20
Balfour Retractor	46	Crimping Forceps	8	Ex Fix Tissue Protection Sleeve	32	Hatt Curette	26
Bandage Scissors	78	Cruciate Repair Line / Crimp / Needle	6	Excision Arthroplasty Rasp	20	Hatt Spoon	26
Barraquer Eyelid Speculum	98	Curette - Arthroscopic	50,51,52,60	Explorer Probe	90	Heavy Duty Needleholders	10
Basket - Premium	103	Curette - Supraringival	90	External Fixation Bars	63,64,65	Hex Screwdriver	29
Beaver Blade Handle	82	Curette OCD	22	Extraction Forceps	94,96	HIF Kits	118,119
Biopsy Set Arthroscopic	50,51,52,59	Cutter - Bone	40	Eye Enucleation Forceps	98	Hip Instruments	24,25
Bone Cutter	40	Cutter - Implant	41	Eye Enucleation Scissors	98	Hip Toggles	8
Bone Holding Forceps	36	Cutter - Implant	40,41,67	Eye Enucleation Spoon	98	Hohman Angled	25
Bone Holding Forceps	36,37	Cutter - Wire	47	Eyelid Speculum	98	Hohman Retractor	22
Bone Pin Roll	58,123	Debakey Needle Holders	71	Fat Pad Retractor	19	Hybrid Locking Kit	109
Bone Plate Clips	34	Dental Elevator	91,92	Filters for Premium Boxes	105	ID Tag for Premium Boxes	105
Bone Plate Press	36	Dental Kits	127	Finochietto Rib Retractor	46	Ikuta Clamp	40
Bone Rasp	21	Dental Sets	95	Finsen Retractor	46	Implant Cutter	40,41,67
Bone Rasp Rectangular	21	Depth Gauge	34	Flexible Grasping Forceps	50,51,81	Incisor Luxation	95
Bone Scribe	11	Disarticulator	26	Forceps - Adson	74	Insert Sleeve	33
Bone Tunnel Borer	9	Dissecting Forceps	74	Forceps - Allis	75	Instrument Baskets - Premium	107
Bowel Clamp	80	Distractor Stifle	18	Forceps - Babcock	75	Instrument Boxes - Premium	107
Bowel Clamp - Tonsillectomy	80	Doyen Bowel Clamp	80	Forceps - Bone Holding	36	IOHC Kits	118,119
Box - Ex Fix	68	Dressing Forceps	75	Forceps - Bone Holding	36,37	Iris Scissors	99
Box - Wire Storage	68,121	Dressing Scissors	78	Forceps - Carmalt	80	Jones Towel Clamp	84
Boxes - Premium	102	Drill Bits	56,57,58	Forceps - Dissecting	74	KE Clamps	62
Cage Cutter	15	Drill Bits - Cannulated	58	Forceps - Dressing	75	Kern Forceps	37
				Forceps - Extraction	94,96	Kit Boxes	120
				Forceps - Grasping	50,51,81	Kit Boxes - General	121
				Forceps - Halstead Mosquito	19,73,86	Laminectomy Rongeur	44
				Forceps - Kern	37	Langenbeck Retractor	46
				Forceps - Left Handed	86	Left Handed Instruments	86,87
				Forceps - Plate Holding	38	Lip Retractor	94
				Forceps - Reduction	39	Lister Bandage Scissors	78,86
				Forceps - Rochester Pean	51,86	Load/Neutral Drill Guide	32

Locking Kit Screw Racks	121	Plate Benders - Evolox®	35	Scissors - Left Handed	86	Tissue Protection Sleeve - Ex Fix	66
Locking Kits	112	Plate Bending Pliers	35	Scissors - Metzenbaum	77,78,86	Tonsillectomy Bowel Clamp	81
Locking Plug Box	121	Plate Holding Forceps	38	Scissors - Operating	78	Toothed Halstead Forceps	19
Luxation Incisor	95	Plate Press	36	Scissors - Suture	99	Torx/Star Screwdriver	29
Mallet	22	Plate Spacers	12,13	Scissors - Tenotomy	99	Towel Clamp - Atraumatic	84
Matting - Silicone	124	Plate Tray - Premium	104	Scoop - Volkman	43	Towel Clamp - Backhaus	84
Mayo Hegar Needle Holders	71,87	Pliers	45	Screw Extraction Trepine	43	Towel Clamp - Ball and Socket	84
Mayo Scissors	76,86	Pliers - Plate Bending	35	Screw Holding Sleeve	29	Towel Clamp - Jones	84
McPhails Needleholders	72	Pliers - Wire Contouring	47	Screw Rack - Premium	103,104,106	Towel Clamp - Shardel	84
Measuring Probe	90	Premium Boxes	102	Screw Rack - Standard	104,106	TPLO Boxes	120
Measuring Gauge	27	Premium Screw Rack	103,104,106	Screw Racks - Mini	123	TPLO Jig	11
Meniscal Hook Blade	20	Premium Screwdriver Handle	31	Screw Racks -Standard	122	TPLO Kits	115,116,117
Meniscal Knife	20	Quick Release Adapter	27	Screw/Drill Measuring Gauge	27	TPLO Rotation Caliper	11
Meniscal Nerve Hook	20,50	Quick Release Drill Bits	56	Screwdriver	29	TPLO Rotation Chart	11
Meniscal Push Blade	20	Quick Release Handle	31	Screwdriver Handle	31	TPLO Tray	104
Meniscus Probe	20	Quick Release Screwdriver Tips	29,30	Screwdriver Suture Screw	30	TPLO Wedge Set	11
Mesh Basket - Premium	103	Rasp Trochlea	21	Screwdriver Tips	29,30	Trepine - Screw Extract	43
Metric Ruler	27	Reduction Forceps	39	Self Centring Drill Guides	33	Treves Dissecting Forceps	74
Metzenbaum Scissors	77,78,86	Retractor - Balfour	46	SF Clamps	64	Trochlea Rasp	21
Modular Osteotome	26	Retractor - Caspar	46	Shardel Towel Clamp	84	TTA Cage Cutter	15
Molar Cutter	95	Retractor - Finochietto	46	Sickle Scaler	90	TTA Cage Forceps	14
Molar Luxation	95	Retractor - Finsen	46	Silicone Matting	124	TTA Depth Gauge	15
Molt Elevator	42	Retractor - Gelpi	17,25,79	Smith Kerrision Rongeur	44	TTA Instruments	14
Mouth Gag - Grays	90	Retractor - Gosset	46	Soft Palate Clamp	80	TTA Osteotomy Saw Guide and Stopper	14
Mouth Gag - Rodent	95	Retractor - Langenbeck	46	Soft Tissue Kit	28	TTA Plate Bender	15
Needle Box	122	Retractor - Weitlander	46	Spanners	65	TTA Saw Guide	14
Needle Holders - Debakey	71,74	Retractor Hohman	22	Spay Forcep	83	TTA Spreaders	16
Needle Holders - Gillies	71,87	Retractor Volkman	43	Spay Hook	83	Tube Holder	68,80
Needle Holders - Mayo Hegar	87	Retractor -Weitlander	46	Spay Kits	83,127	Victory Modular System	102
Needle Holders - McPhails	72	Retractors - Gelpi	17	Speculum - Eye	98	Volkman Retractor	43
Needle Holders Castroviejo	72,99	Rochester Pean Artery Forceps	74,86	Spencer Wells Artery Forceps	28,73	Volkman Scoop	43
Needle Holders -Olsen Hegar	71,87	Rodent Molar Cutter	98	Spikey Washer	48	Washer	48
Needleholders - Left Hand	87	Rodent Molar Forceps	95	Spinal Rongeur	44	Webb Bolts	45
Needleholders - Ophthalmic	99	Rodent Mouth Gag	95	Spinal Scaler	42	Wedge Set	11
Needleholders Heavy Duty	10	Rongeur	44	Split Clamps	62	Weitlander Retractor	46
Nerve Hook	20,50	Rongeur - Spinal	44	Staple Remover	85	Winged Elevator	91
OCD Curette	22	Rosens Mobiliser	42	Stapler	85	Wire - Cerclage	48
Odd Leg Gelpi	17,79	Rotation Caliper	11	Stifle Distractor	18	Wire Bender	47
Olsen Hegar Needle Holders	71,87	Rotation Chart	11	Stifle Lever	19	Wire Passer	47
Operating Scissors	76,77	Ruler Metric	27	Stifle Lever	50,51,52,61	Wire Storage	68,121
Ophthalmic Kit	100,128	Ruskin Rongeur	44	Suction Tips	124	Wire Tightner	48
Ormrod Buttons	8	Scaler - Spinal	42	Suture Scissors	99	Wire Twister/Cutter	47
Orthopaedic Bone Rasp	21	Scalpel Blade Set	21	Suture Screw Kits	115	Wire/Pin Punch	47
Osteotome Modular	26	Scalpel Blades	82	Suture Screwdriver	30	Wound Stapler	85
Osteotomes	23,26,50	Scalpel Handles	82	Suture Tensioning Forceps	10	X-Ray Marker	27
Periosteal Elevator	42	Scissor - Mayo	76,86	Table Top Gag	95		
Pin Bender	47	Scissors - Bandage	78	Taps	59		
Pin Cutter	41,67	Scissors - Coloured	78	Tartar Forceps	94		
Pin Grip	45	Scissors - Dressing	78	Tenotomy Scissors	99		
Plate Benders	34,35	Scissors - Iris	99	Tissue Forceps	75		
				Tissue Protection Sleeve	32		

Special thanks to of Dr Ben Garland BVetMed CertAVP(GSAS) MRCVS RCVS Advanced Practitioner in Small Animal Surgery.

Director: DVSR - Debenham Vets Surgical Referrals Ltd for his invaluable veterinary support in trialling and developing new product and ongoing advice to our customers.

N2 (UK) Ltd



Veterinary Supplies

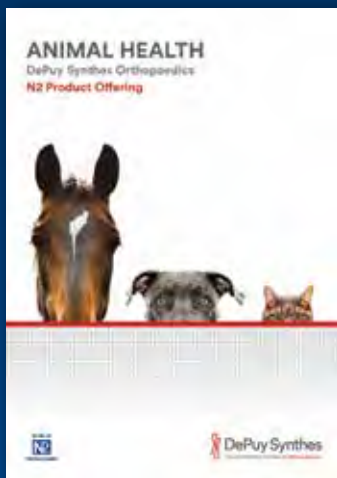

Please contact us for a copy of our additional catalogues

- 🌐 www.n2-uk.com
- ☎ +44 (0)23 9323 3265
- ✂ @n2ukcom
- 📘 www.facebook.com/n2ukltd
- ✉ sales@n2-uk.com
- 🛒 office@n2-uk.com for orders

