

Capital Equipment

N2 (UK) Ltd



Veterinary Supplies



www.n2-uk.com



+44 (0)23 9323 3265



www.facebook.com/n2ukltd



sales@n2-uk.com



office@n2-uk.com for orders

Index

Chapter 1:
Power Tools
page 3 – page 25

Chapter 2:
Sterilisation and Cleaning
page 26 – page 28

Chapter 3:
Arthroscopy
page 29

Chapter 4:
Diagnostics
page 30 – page 33

Chapter 5:
Surgical Theatre Equipment
page 34 – page 35

Chapter 6:
Bone Models/Training Aids
page 36

Chapter 7:
Absorbable Haemostatic Agent
page 37



Our reputation for quality and value has led to many requests for products outside our usual lines.

We have sourced a range of new products to fit these requests using our network of trusted suppliers that we think will compliment our own ranges.

We offer Synthes and Aecsulap power tools as well as our own mid range sets. This includes the new 800 system that offers further grip and power options to what we already offer.

The 3D printed bone models have been out on trial and have been getting excellent feedback from the vets when used in the consult rooms with clients.

If you can't quite see what you need we offer many other options to suit most needs and budgets.

In 2023 we moved into our current warehouse premises just down the road from our manufacturing plant in Portsmouth.

We are proud to continue to manufacture our implants ourselves in the U.K. and offer tours of our facilities to any vets (or nurses) who are interested.

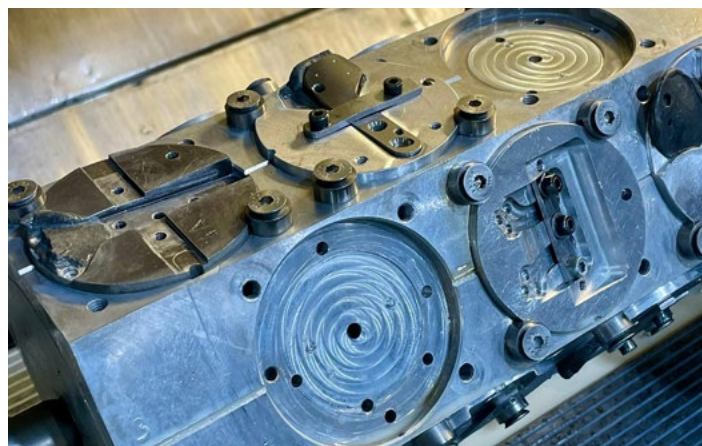

Multi-function Drill Saw System with TPLO



We constantly get asked for an all-in-one unit that covers everything, including TPLO, that doesn't cost the earth to our customers. We finally found the A100 system that fits the bill. A robust sturdy handpiece with a large range of attachments. We have collated 5 of the most common attachments together in a kit that offers fantastic value under £4000

Order Code	Description	RRP
PT-A100-SET	Full Modular Kit including Handpiece, 1 Battery, Charger, Transfer Device, Jacobs Chuck, AO Attachment, Oscillating Saw, K Wire Attachment, TPLO Saw	£3,950.00
PT-A100-HP	Handpiece including 2 Batteries, Charger and Transfer Device	£2,000.00
PT-A100-JC	Jacobs Chuck Attachment 0.8mm - 8mm	£420.00
PT-A100-AO	AO Drill Attachment 0.8mm - 8mm	£420.00
PT-A100-OS	Oscillating Saw Attachment 18000rpm	£420.00
PT-A100-KW-S	A+100 K Wire Attachment Small 0.2mm - 2.0mm	£420.00
PT-A100-KW-L	A+100 K Wire Attachment Large 1.5mm - 3.2mm	£420.00
PT-A100-TPLO	TPLO Saw Attachment	£500.00
PT-A100-BAT	Spare Battery	£70.00

Other attachments are available

Oscillating Saw Blade Sizes Available

Blade sizes
30*10*0.5
35*8*0.5
39*13*0.5
45*32*1.2
46*10*0.5
50*13*0.8
55*15*0.5
70*13*1.0
70*22*0.8
70*24*1.0
70*24*1.2
90*13*0.8
90*13*1.0
90*13*1.2
90*19*1.2
90*22*0.8
90*22*1.2
90*24*1.0
90*24*1.2
100*13*1.0
100*22*1.2
110*22*1.2

all saw blade listed are shown as Length*Width*Thickness



“A good all rounder with the versatility to suit the vast majority of orthopaedic procedures at a fraction of the cost of others in the market”

Dr Chris Lancelott BSc(Hons) DVM(Hons) CertAVP(GSAS) MRCVS

Medical High End 800 Modular Saw/Drill System

The newest offering of our mid-range power tool range is the 800 system. Comprising a large selection of attachments including TPLO saw, the system will cover all your orthopaedic needs.



A very balanced unit full of Torque

- The motor is same brand as the Stryker. The American-imported brushless motor drive features low noise and strong power.
- 2200 mAh high capacity battery. A split design for the main unit and battery box, quick-release & install during surgery.
- The main unit features an integrated aluminium alloy design with an ergonomic curvature for a comfortable grip.
- The battery box cover includes a visible dual-locking mechanism, eliminating the risk of battery disconnection during surgery.
- The main unit is equipped with a multifunctional quick-change interface, allowing for the rapid exchange of compatible connectors. It supports 360° rotation of various connectors, enabling use in different types of surgical procedures.
- The charger features a battery level display and detection function, applicable for pre-surgery battery level checks and real-time monitoring of battery charge during the charging process.
- An optional four-port charger is available, capable of charging up to four batteries simultaneously.



ITEM NO.	Gripping Range	Speed
K-wire Holder	0.8-2.0/1.5-3.2 mm	0-1200 rpm
Bone Drill Attachment	0.8-7.9 mm	0-1200 rpm
Acetabular Reaming Drill	1.0-8.1 mm	0-300 rpm
Oscillating Saw	/	0-18000 cpm
Cranial Bur	/	0-36000 rpm
Cranial Drill	/	0-800 rpm
Sternum Saw	/	0-14000 cpm
Reciprocating Saw	/	0-14000 cpm
TPLO Saw	/	0-14000 cpm

Order Code	Description	RRP
PT-800-SET	Comprising Handpiece, Battery, Charger and the following modular options – Jacobs Chuck, AO Drill, K-Wire Holder, Oscillating Saw and TPLO Attachment	£8000.00
PT-800-HP	Handpiece including Battery, Charger and Transfer Device	£5500.00
PT-800-JC	Jacobs Chuck Attachment 0.8mm – 7.9mm	£600.00
PT-800-AO	AO Drill Attachment	£600.00
PT-800-OS	Oscillating Saw Attachment	£850.00
PT-800-TPLO	TPLO Saw Attachment	£900.00
PT-800-KW-S	K-Wire Driver Attachment 0.8mm – 1.8mm	£650.00
PT-800-KW-L	K-Wire Driver Attachment 1.5mm – 3.2mm	£650.00
PT-800-RM	Acetabular Reamer (Various models available)	£650.00
PT-800-BAT	Spare Battery	£300.00
PT-800-CHARGE-4	Battery Charger for 4 Batteries	£800.00

N2 Modular Autoclavable Power System

The recently launched system brings high quality orthopaedic power at an excellent price.

The kit consists of

- Cannulated Handpiece
- Wire Driver (0.7-1.8mm Wires)
- AO Quick Release Attachment
- Mini Stainless-Steel Chuck and Key
- Oscillating Saw Attachment
- One Battery and Two Transfer Devices
- Carry Case

There is also an optional sterilisation tray that fits all the autoclavable items.

- Battery Charge Time – 2 Hours
- Battery Usage – 30 Mins Constant Use
- Speed 0-2000rpm
- Autoclave up to 135 Degrees (Excluding Batteries)

Autoclavable Modular Drill

Order Code	Description	RRP
AC-FULL-SET	Modular Autoclavable Drill and Saw with Chuck, Quick Release, Oscillating Saw and Wire Driver Attachments, One Battery	£3,650.00
AC-FULL-SET-BAT	Spare Battery for Autoclavable Modular Drill	£70.00



Contact us to ask about a trial

Oscillating saw blade sizes available

Blade size
22*8*0.5
22*12*0.5
22*15*0.5
25*5.5*0.5
25*9.5*0.5
29.5*7*0.5
31*9.5*0.5
35*8*0.5
39*13*0.5
40*5*0.5
40*15*0.5
42*11*0.5
46*10*0.5
50*14*0.5
50*24*0.8

all saw blade listed are shown as Length*Width*Thickness

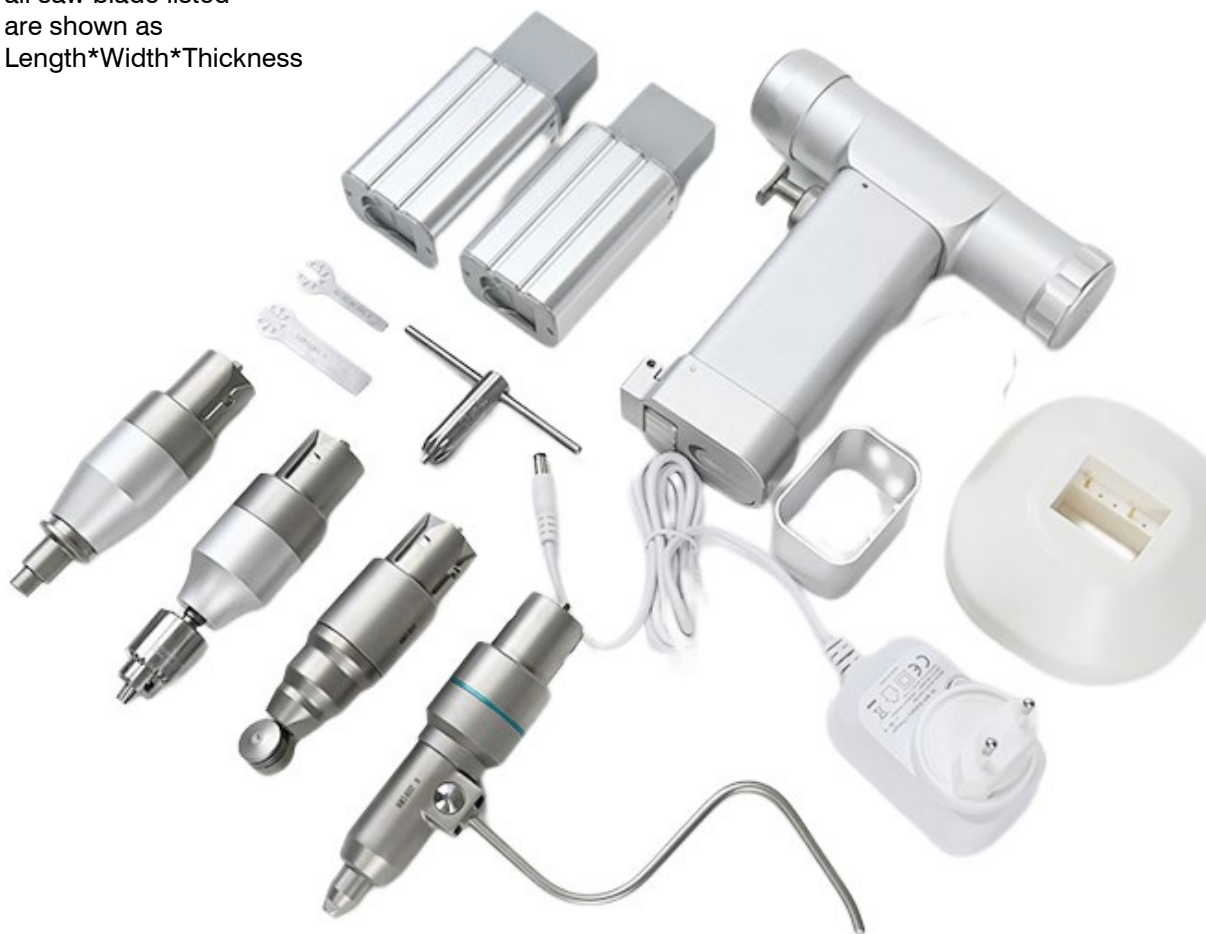

N2 (UK) Ltd



Veterinary Supplies

UNIUM™

Small Bone and Trauma Platform

CONNECT WITH POWER

Product Brochure





Ergonomics

- Improved comfort and control
- Intuitive user interfaces, fast set-up
- +18% power for demanding procedures
- Well-balanced and natural fit in the hand

Reliability

- Extended lifespan for decreased cost of repair and waste
- Electronics protected from reprocessing
- Long-lasting Li-Lon battery
- Powerful and durable brushless motor
- High quality materials

Efficiency

- The Power of One: simplicity and cost efficiency
- One Power Tool for Small Bone and Trauma applications
- One Power Unit drives both handpieces
- One set of cutting tools, attachments and a charger that are backwards compatible
- One tool for synergies in reprocessing, education and service
- +18% Increased Power for demanding procedures with improved torque/speed ratio
- 19% Lower Weight for more comfort and balance

Order Code	Description	RRP
SY-05.001.601	Unium Handpiece	£10,196.12
SY-05.001.602	UNIUM™ Power Unit	£3646.18
SY-05.001.603	UNIUM™ Sterile Cover	£78.90
SY-05.001.604	UNIUM™ Adapter for Universal Battery Charger II	£345.09
SY-05.001.250	AO/ASIF QC Attachment	£469.99
SY-05.001.252	Chuck and key up to 4.0mm	£594.93
SY-532.011	Mini QC Attachment	£493.73
SY-532.017	AO QC Medullary Reamer	£1859.97
SY-532.021	Oscillating Saw Attachment	£4209.51
SY-05.001.118	K Wire Driver Attachment	£2980.71
SY-532.023	Tplo Saw Attachment	£4209.51
SY-532.027	Spare Key for TPLO Saw	£60.92
SY-03.000.390	TPLO Saw Blade 12mm	£232.99
SY-03.000.391	TPLO Saw Blade 15mm	£232.99
SY-03.000.392	TPLO Saw Blade 18mm	£232.99
SY-03.000.393	TPLO Saw Blade 21mm	£232.99
SY-03.000.394	TPLO Saw Blade 24mm	£232.99
SY-03.000.395	TPLO Saw Blade 27mm	£232.99
SY-03.000.396	TPLO Saw Blade 30mm	£232.99

Please contact us for additional Unium parts or to arrange a trial

Please contact us for more information on Synthes J&J original Implants

UNIUM™ System

Small Bone and Trauma Platform

Designed with a commitment to ergonomics, reliability and efficiency, so the focus remains on the patient, without distraction.^{2,3}

One system for use in trauma, sports medicine, spine and cardiothoracic surgery.²

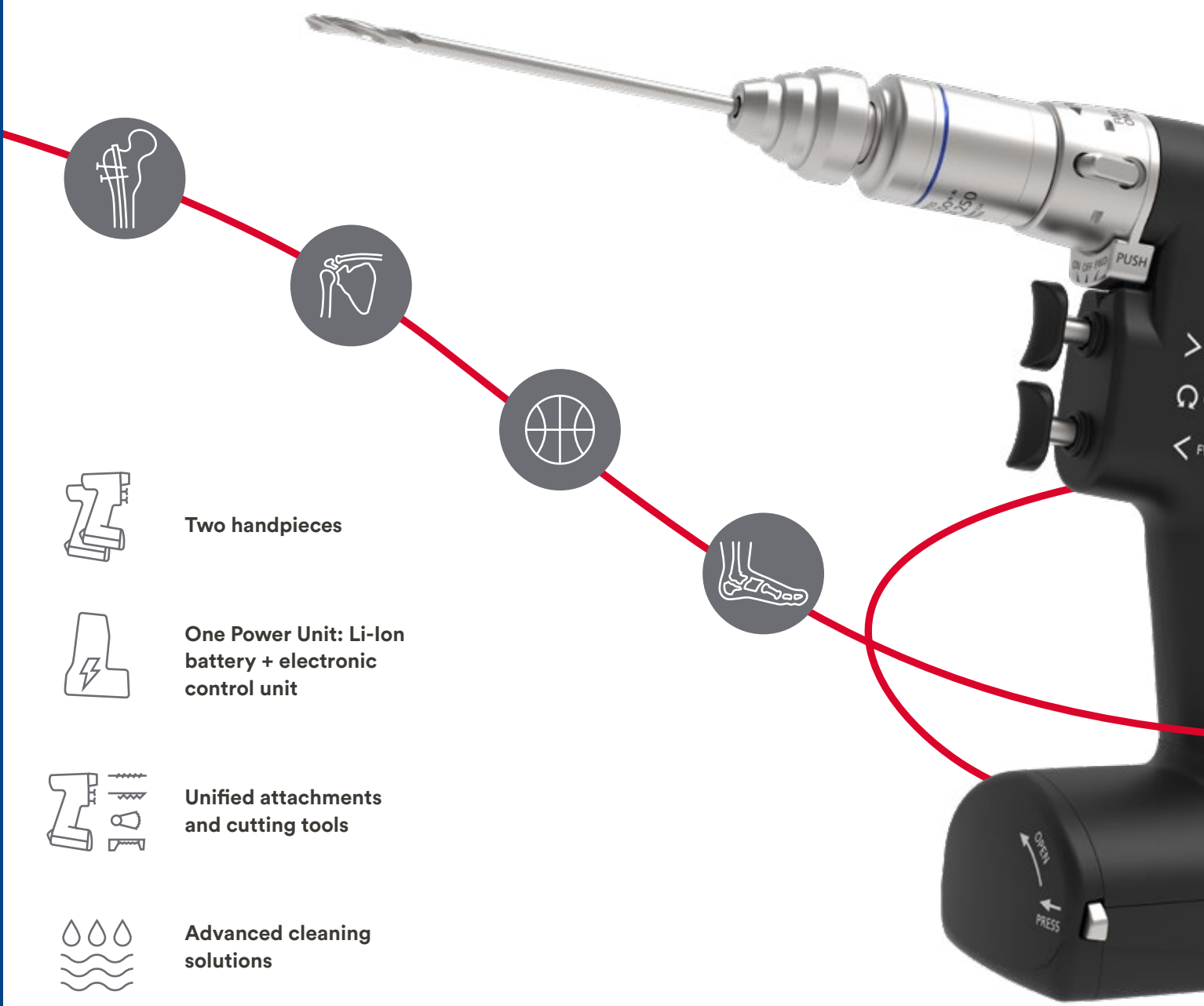

Two handpieces



One Power Unit: Li-Ion battery + electronic control unit



Unified attachments and cutting tools



Advanced cleaning solutions



Ergonomics

Improved comfort and control^{*2,4}

- Intuitive user interfaces, fast set-up²
- Compact design – lower weight and reduced size^{*2,3,5}
- +18% power for demanding procedures³
- Well-balanced and natural fit in the hand²

Reliability

Extended lifespan for decreased cost of repair and waste⁶

- Electronics protected from reprocessing⁶
- Long-lasting Li-Ion battery⁷
- Powerful and durable brushless motor³
- High quality materials

Efficiency

The Power of One: simplicity and cost efficiency²

- One Power Tool for Small Bone and Trauma applications²
- One Power Unit drives both handpieces
- One set of cutting tools, attachments and a charger that are backwards compatible
- One tool for synergies in reprocessing, education and service²

UNIUM™ System

Stronger, Lighter and More Versatile*5

100W sterilizable brushless motor
for enhanced performance*3

Easy to use click-in connection²
of the reciprocating saw
blade and top for sternum

Active mode
visible when operating



Reciprocating Saw



+18%

Increased Power*

for demanding procedures with improved torque/speed ratio³

-19%

Lower Weight*

for more comfort and balance^{4,5}



Modular Handpiece



UNIUM™ Power Unit Technology

Tested to function for a minimum of 1,000 charging cycles^{9*}, the innovative UNIUM Power Unit Technology is designed for increased reliability, longer lifetime, sustainability and cost effectiveness.^{6,10}

The Power Unit incorporates the Electronic Control Unit (ECU) that is traditionally included in the handpiece, in the battery casing/pack.

The nonsterile Power Unit can be securely inserted into the handpiece using an aseptic transfer technique, preventing the temperature/humidity sensitive parts (battery cells and Electronic Control Unit) from being exposed to lifetime limiting stress resulting from cleaning and sterilization processes.^{6,10}

>1,000
use and charging cycles^{9*}

Electronic Control Unit

Latest technology in high power Li-Ion battery cells
offer suitable battery capacity for intended surgical application⁷

The Power Unit technology may result in decreased costs by a potential reduction in overall system failure rate, down-time, replacement or repair frequency and reprocessing.⁵

The Power Unit high capacity and reliability reduce the risk of requiring intraoperative battery change.^{2,6}



Aseptic transfer technique

was shown safe and effective when performed according to the instructions for use by an independent laboratory.¹⁰

**Battery level indicator**







visible at any time before, during and after surgery on the Power Unit and through the bottom of the handpiece



Power Unit is compatible with existing Universal Battery Charger II**

UNIUM™ Modularity

Comprehensive Portfolio of Attachments and Cutting Tools³

<p>Kirschner Wire</p> <p>For Kirschner Wires 0.6 to 3.2 mm Redesigned to have a more tapered front -end and higher speed*⁵</p>	
<p>Drill</p> <p>AO/ASIF, Square and Trinkle Quick Coupling, Jacob's Chuck Radiolucent Drive</p>	
<p>Ream</p> <p>Redesigned smaller and lighter reaming attachments with reverse motion¹¹</p>	
<p>Screw</p> <p>AO/ASIF coupling Square Quick Coupling, High torque (Tap/Screw)</p>	
<p>Burr</p> <p>Attachment is compatible with Small Bone Small Torx coupling burrs, sizes Medium (M) and Long (L)</p>	
<p>Saw</p> <p>Oscillating Saw Attachment for sagittal and parallel saw blades</p> <p>Oscillating Saw Attachment II for crescentic or angled saw blades</p> <p>For Large Oscillating Blades</p>	

UNIUM™ Sternum Solutions

Reciprocating Saw Handpiece for Primary Sternotomy

Top for sternum

provides adequate stability²
during the sternotomy

Round-shaped sternum guard

designed for soft tissue protection²

Primary sternum opening saw blades

available in two
different thicknesses

Modular Handpiece and Saw Blades for Sternum Re-Opening

Sternum re-opening saw blades

available in five different designs

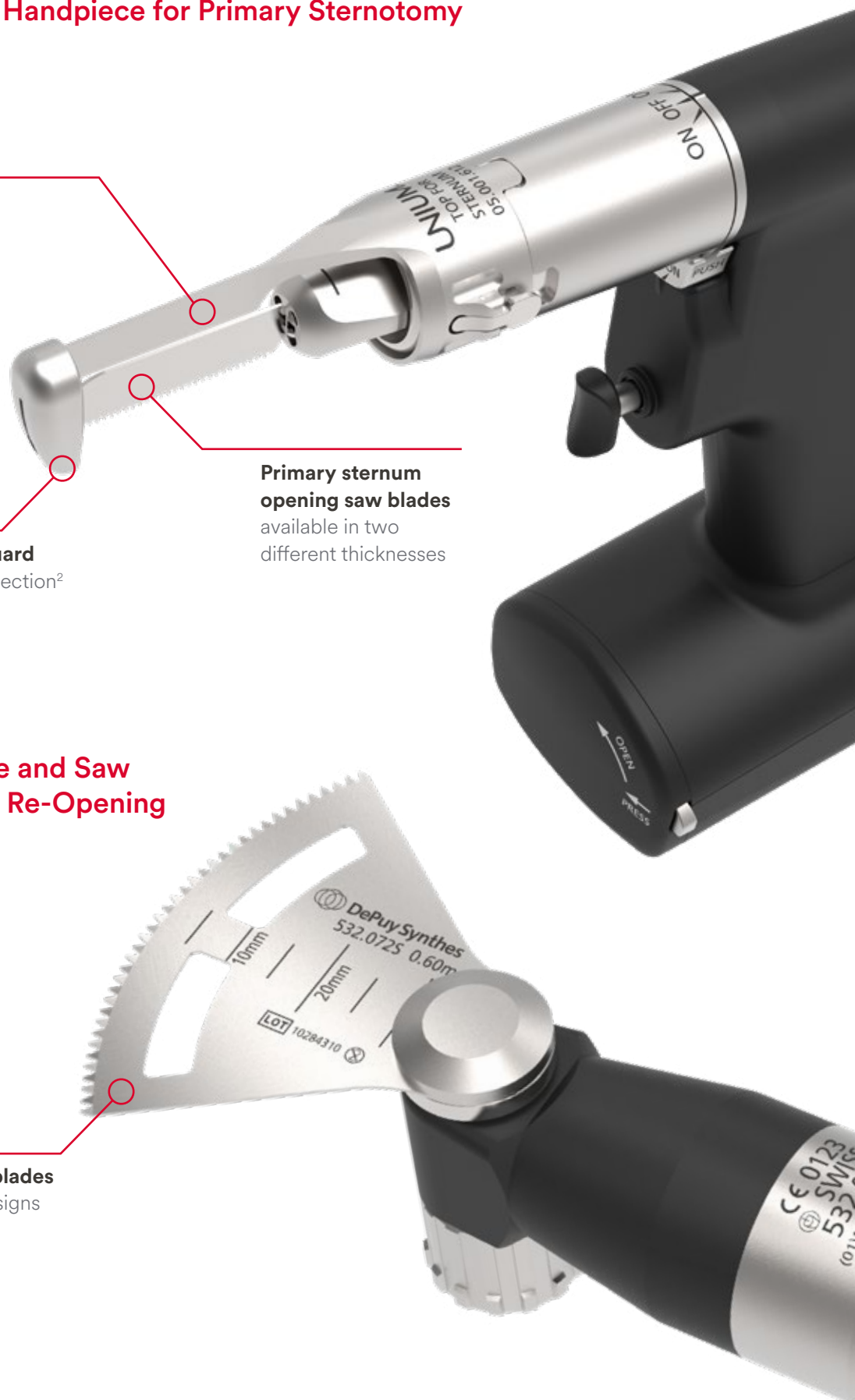

Advanced Cleaning Solutions

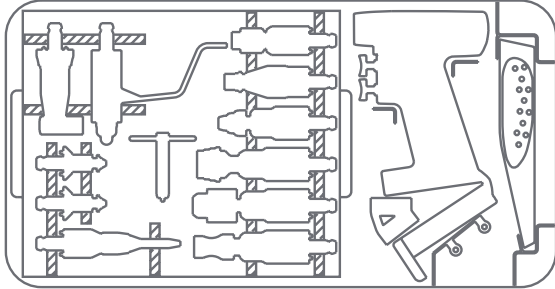

Loading Plan
attached to the basket

Size 1/1

Washing and Sterilization Basket
for Modular Handpiece

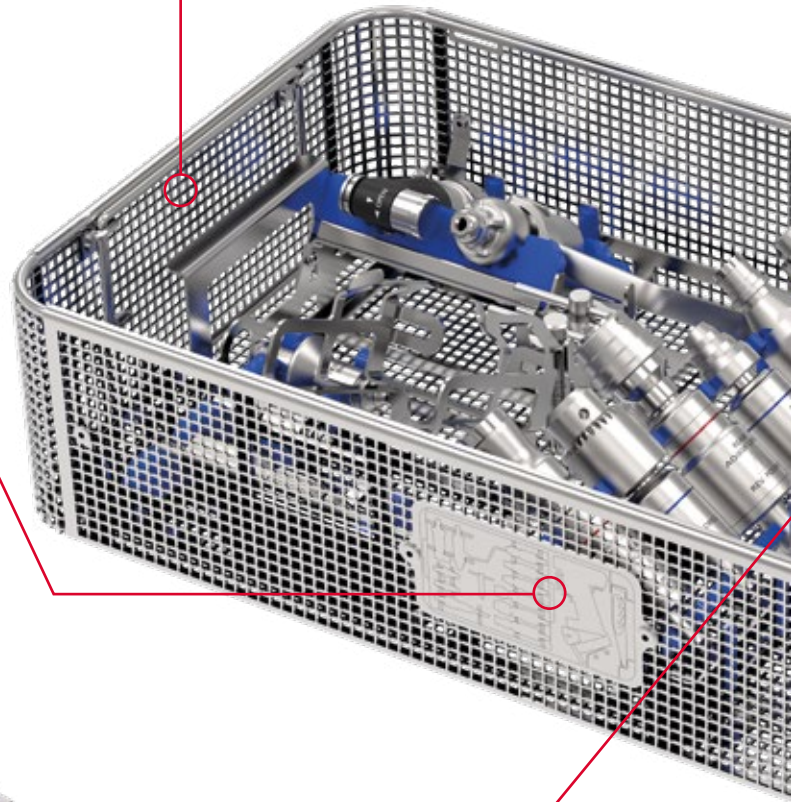

Removable Insert Tray
Can be used as OR stand for reduced footprint and to facilitate attachment loading

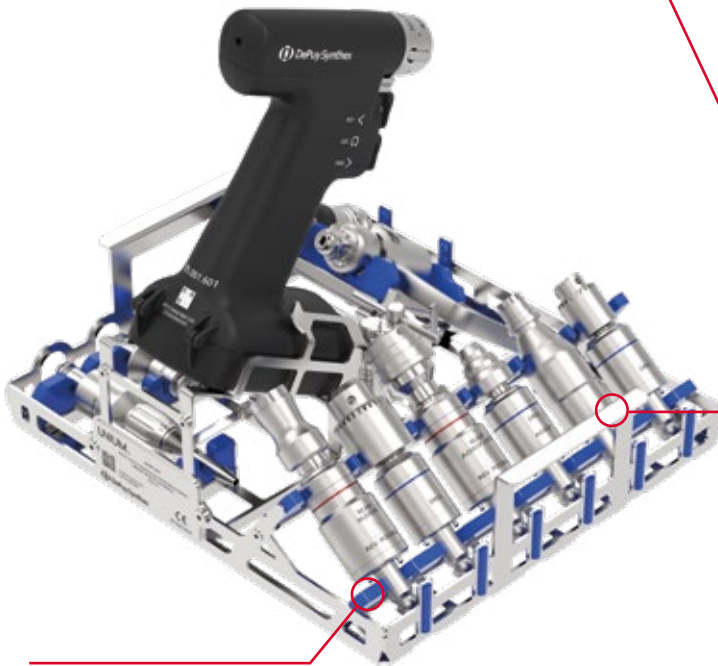

Silicone bracket
designed for secure placement²

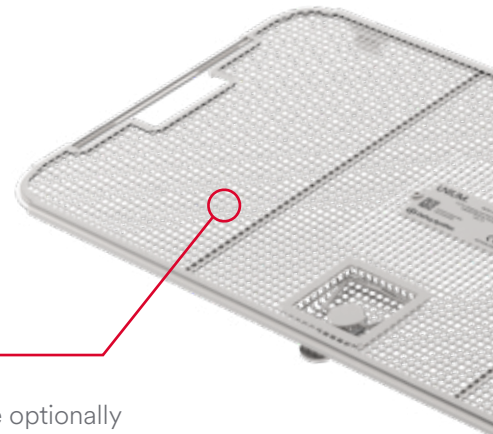

Lid
available optionally

Compatible with standard rigid sterilization containers¹²

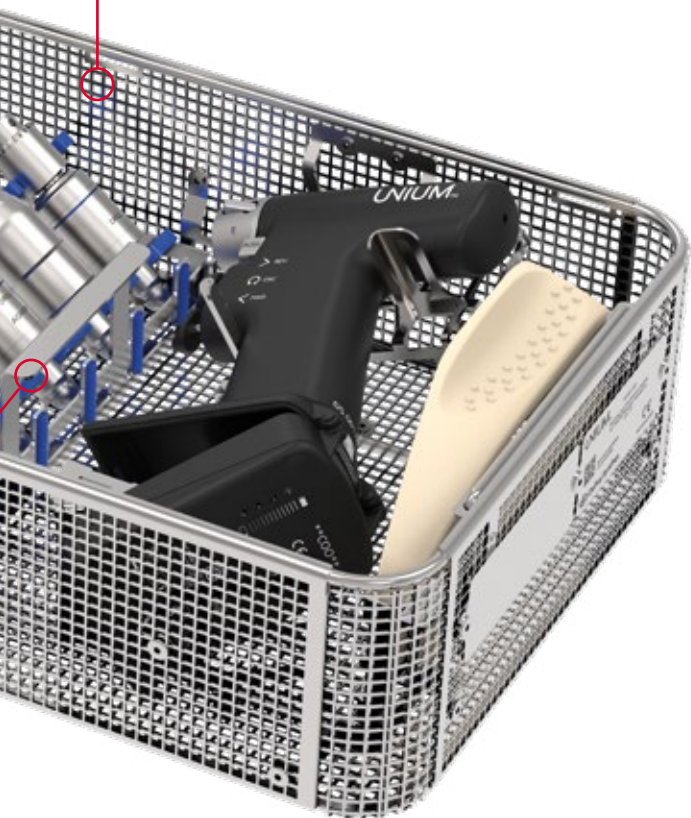

Size 1/2

Washing and Sterilization Basket
for Reciprocating Saw Handpiece



Size 1/3

Washing and Sterilization Basket
for Modular Handpiece

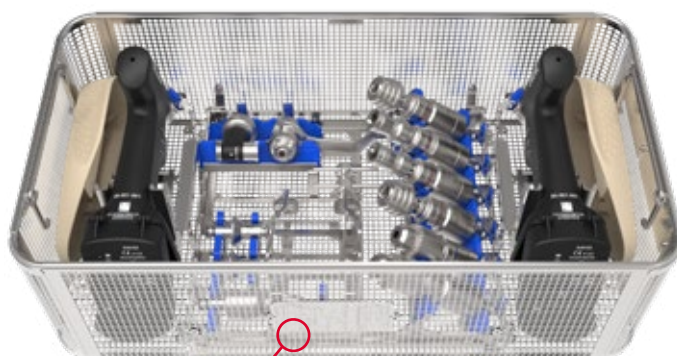

Size 1/1

Washing and Sterilization Basket with insert tray
for two Modular Handpieces



Acculan unit

AESCULAP

Acculan 4

Small Drill

LOW RUNNING COSTS

Thanks to Quality and Service:

- Long lifespan due to unsterile batteries and low running costs
- Battery exchange at a fixed price
- High grade materials for high requirements: Titanium, Stainless Steel, PEEK

OUTSTANDING ERGONOMICS

Small tool for small patients:

- Rounded organic shape of the grip area
- Handle incorporates the battery and avoids a bulky battery compartment
- Small and light weight with a good visibility on surgical field

MECHANICAL CLEANING

Thanks to the titanium housing and the ECCOS® storage solution Acculan 4 is suitable for mechanical and manual cleaning, even with alkaline cleaning media. Rinsing adaptors for cleaning of lumens like cannulation and saw blade coupling in the washer.

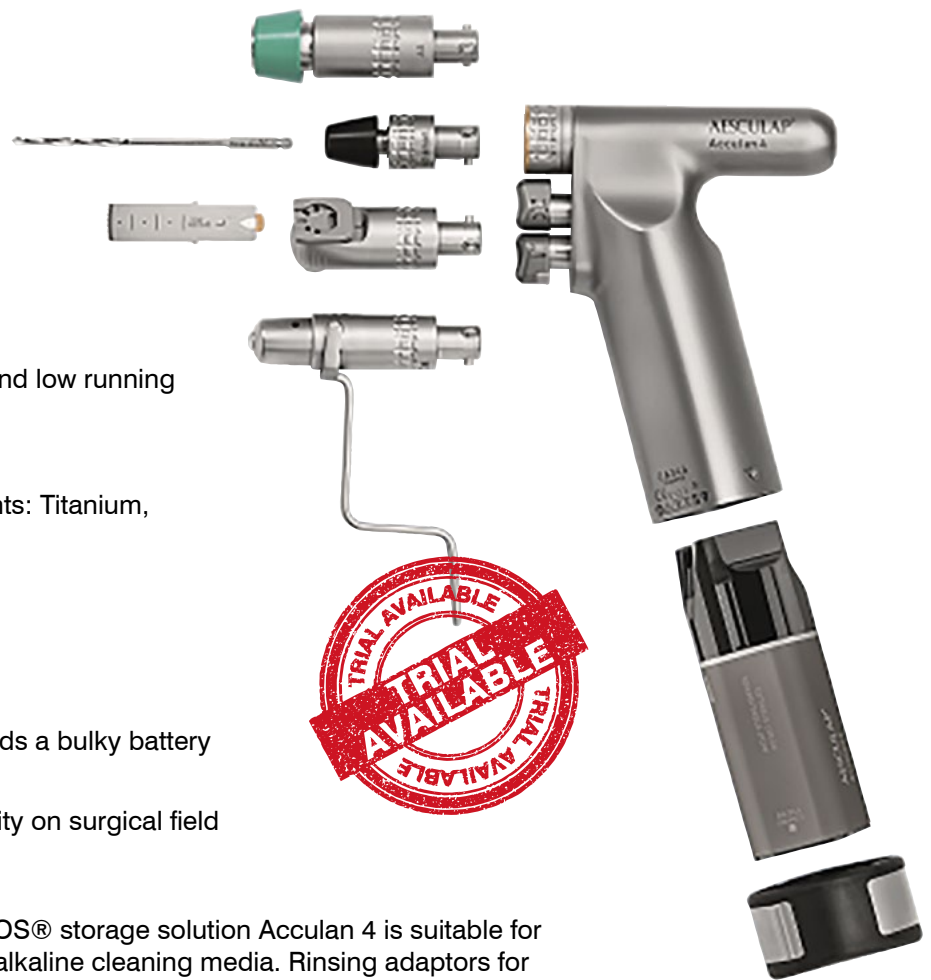

Drills and Attachments

Order Code	Description	RRP
AC-4-HP	Acculan 4 Small Drill	£9,132.00
AC-4-AO	Drill Attachment with Small AO chuck	£1,511.00
AC-4-SAG	Sagittal Saw Attachment for L-Sagittal Saw-Blades with a Maximum Usable Length of 50mm	£3,526.00
AC-4-JC	Drill Attachment with Jacobs Chuck 0.5mm - 7.4mm	£1,511.00
AC-4-KW	Attachement for K-wires 0.6mm - 3.2mm	£3,526.00
AC-4-CHARGE	Acculan 4 Charger (fits 4 batteries) and Power Cord	£4,040.00
AC-4-BAT	Acculan 4 Lithium-ION Battery	£1,637.00
AC-4-LID	Acculan 4 Battery Compartment Lid	£549.00



Acculan TPLO Saw

The Acculan 4 TPLO Saw is the next generation of battery operated drill systems. This saw was designed to deliver an accurate cut with maximum power. The ergonomic design offers easy handling with precise surgical precision. The novel motor and control concept offers the kind of performance previously found only in the Elan and Pneumatic systems. This saw is only for TPLO procedures.



Order Code	Description	RRP
AC-TPLO-SAW	Acculan TPLO Saw	£9,132.00

Order Code	Description	RRP
AC-TPLO-BL12	Aesculap TPLO Saw Blade 12mm	£436.00
AC-TPLO-BL15	Aesculap TPLO Saw Blade 15mm	£436.00
AC-TPLO-BL18	Aesculap TPLO Saw Blade 18mm	£528.00
AC-TPLO-BL20	Aesculap TPLO Saw Blade 20mm	£528.00
AC-TPLO-BL24	Aesculap TPLO Saw Blade 24mm	£549.00
AC-TPLO-BL27	Aesculap TPLO Saw Blade 27mm	£616.00
AC-TPLO-BL30	Aesculap TPLO Saw Blade 30mm	£635.00

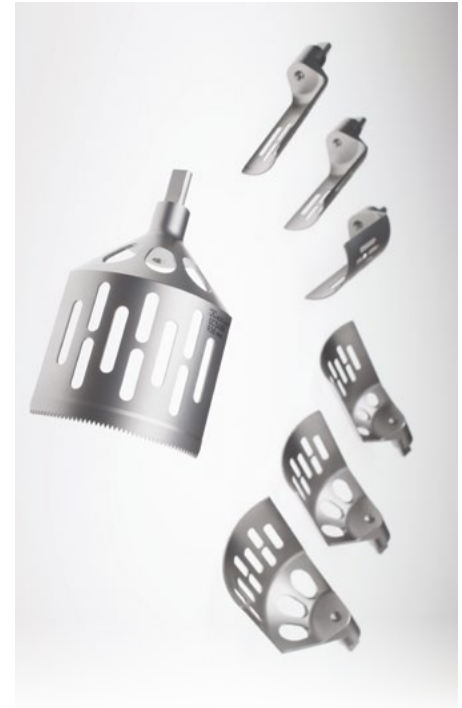

TPLO Saw

A great versatile TPLO Saw suitable for regular or occasional use.

Comes with a 12-month Warranty.

Will fit all tri-fit tplo saw blades including the Acculan ones we have listed on previous pages.



Order Code	Description	RRP
TPLO-KIT	Comprises Autoclavable TPLO Saw, Two Batteries and Charger	£3,400.00

Order Code	Description	RRP
TPLO-BL-9	Economy TPLO Saw Blade 9mm	£250.00
TPLO-BL-12	Economy TPLO Saw Blade 12mm	£250.00
TPLO-BL-15	Economy TPLO Saw Blade 15mm	£250.00
TPLO-BL-18	Economy TPLO Saw Blade 18mm	£250.00
TPLO-BL-21	Economy TPLO Saw Blade 21mm	£250.00
TPLO-BL-24	Economy TPLO Saw Blade 24mm	£250.00
TPLO-BL-27	Economy TPLO Saw Blade 27mm </td <td>£250.00</td>	£250.00
TPLO-BL-30	Economy TPLO Saw Blade 30mm	£250.00
TPLO-BL-33	Economy TPLO Saw Blade 33mm	£250.00

Order Code	Description	RRP
TPLO-KIT-BOX	300 x 246 x 73mm Sterilisation Box 1 battery included	£200.00

Check sizes will fit your autoclave. Other storage options are available if not.

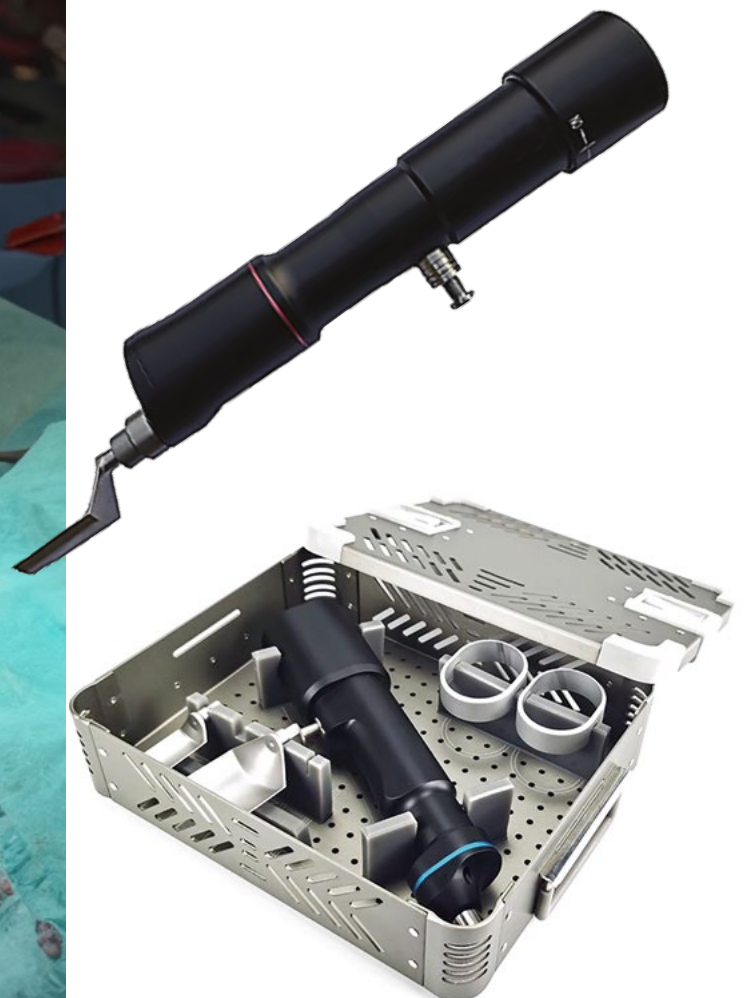

Electric Pen Drive

The Electric Pen Drive System is a light high-speed system that provides the surgeon with the highest level of control during general orthopaedic trauma, foot, hand, maxillofacial, neurosurgical, oral, otolaryngological, reconstructive and spine surgery. With a wide range of attachments and the latest in torque control and irrigation control technology, the Electric Pen Drive sets a new standard in high-speed surgical instrumentation.



Lightweight drive unit provides the surgeon with the level of control required during delicate surgeries.



Release ring for attachment
– Automatic locking
– Eight different positions

Rotary direction switch with safety OFF switch

Drive Unit (05.001.010)

- Speed (without attachment): 0–60,000 rpm
- Weight: 183 g (6.2 oz)
- Clockwise and counterclockwise rotation

- Simple set-up in OR
- Easy operation
- Controls speed and irrigation
- Limits torque
- Quick cable connection

Slide control
For adjusting maximum speed for Drive Unit 2

Selection switch
For torque limiting

Slide control
For adjusting maximum speed for Drive Unit 1

ON/OFF LED

Connector
For Small Battery Drive Adaptor



Sawing

Sagittal saw
For Synthes sagittal saw blades for Electric Pen Drive



Reciprocating saw
For Synthes reciprocating saw blades for Electric Pen Drive



Oscillating saw
For Synthes crescentic and mandibular blades for Electric Pen Drive



Inserting screws (400 rpm)

Screw insertion attachments with AO, mini quick or hex coupling. Optimal speed for power driven insertion of screws.



45° Drill Attachment

05.001.120 Drill Attachment, with Jacobs chuck

– Speed: 0 to 1800 rpm

– Function: 1.6 mm cannulation permits the use of this attachment for drilling and reaming over K-wires (e.g., for cannulated screws and for cup and cone technique)



Order Code	Description	RRP
PD-05-001-002	Basic Hand Switch	£4,044.00
PD-05-001-010	Drive Unit 0-60000 RPM	£3,143.00
PD-05-001-032	AO/ASIF Coupling	£1,030.00
PD-05-001-037	K-WIRE Attachment	£2,358.00
PD-05-001-039	Sagittal Saw Attachment	£2,358.00
PD-05-001-040	Reciprocating Saw Attachment	£2,358.00
PD-05-001-046	Burr Attachment Medium	£1,100.00
PD-05-001-012	Hand Switch	£260.00
PD-05-001-021	Cable Drive Unit	£804.00

Other attachments available

Aesculap® ELAN 4

The Electric Pen Drive System is a light high-speed system that provides the surgeon with the highest level of control during general orthopaedic trauma, foot, hand, maxillofacial, neurosurgical, oral, otolaryngological, reconstructive and spine surgery. With a wide range of attachments and the latest in torque control and irrigation control technology, the Electric Pen Drive sets a new standard in high-speed surgical instrumentation.

The components of the ELAN 4 drill are compatible with the Acculan 4 small drill. Attachments and tools can be combined interchangeably among the two systems.

PRECISE

Low-fatigue, high precision work.

- Handpieces are shorter and lighter
- Runs smoothly
- Fits comfortably in the hand
- More secure hold

POWERFUL

Work quickly, powerfully, and reliably.

- No loss of power
- Rotational speed transferred directly, preventing angle from heating up
- Compact construction - no extra switch

INTUITIVE

The streamlined system is set up clearly for a trouble-free use. Fewer components and a universal burr length offer saving potentials.

- Simple handling
- Standardised burr lengths and clear coding of burrs
- Handpiece will always contain the correct motor
- All types and sizes of burrs are available for all handpiece lengths



Order Code	Description	RRP
	Basic set up for high speed burring	
PT-ELAN-GA861	ELAN 4 Electro 1-ring Handpiece I4	£5,150.00
PT-ELAN-GA862	ELAN 4 Electro 1-ring Handpiece I7	£5,540.00
PT-ELAN-GA863	ELAN 4 Electro 1-ring Handpiece I10	£5,955.00
PT-ELAN-GA806	ELAN 4 Electro Motor cable f/foot control	£2,560.00
PT-ELAN-GA800	ELAN 4 Electro Montrrol unit	£10,310.00
PT-ELAN-GA808	ELAN 4 Electro Foot Control	£3,100.00
PT-ELAN-TE34	Mains Cord 5m Long	£84.00
	Drill handpiece and attachments	
PT-ELAN-GA844	ELAN 4 Electro Drill	£10,220.00
PT-ELAN-GB881R	Drill Attachment Large Jacobs	£1,515.00
PT-ELAN-GB894R	K-wire Attachment	£3,527.00
PT-ELAN-GB891R	Sagittal Saw Attachment	£3,527.00
PT-ELAN-GB884R	Drill Attachment AO-small	£1,515.00
	Accessories	
PT-ELAN-GB861P	ELAN 4 length Reduct Sleeve f/1-Ring Handpiece	£488.00
PT-ELAN-GA804	Elan 4 Electro Motor Cable w/Hand Switch	£4,488.00
PT-ELAN-GA805	ELAN 4 Electro Motor Cable w/Hand Control	£4,225.00
PT-ELAN-GA810	ELAN 4 Electro Wireless Foot Control	£3,480.00
PT-ELAN-GB945R	ELAN 4 Holding Sleeve F/Craniotome	£820.00
	Craniotome options	
PT-ELAN-GA849	ELAN 4 Electro Craniotome 2-Ring	£6,710.00
PT-ELAN-GB941R	ELAN 4 Fixed Duraguard Paediatric	£1,121.00
PT-ELAN-GB942R	ELAN 4 Fixed Duraguard Standard	£1,121.00
PT-ELAN-GB943R	ELAN 4 Fixed Duraguard Long	£1,121.00
	Saws	
PT-ELAN-GA831	ELAN 4 Electro Sagittal Saw	£5,630.00
PT-ELAN-GA832	ELAN 4 Electro Reciprocating Saw	£5,630.00
PT-ELAN-GA836	ELAN 4 Electro Micro Sagittal Saw	£5,950.00
PT-ELAN-GA837	ELAN 4 Electro Micro Reciprocating Saw	£5,950.00



Preowned Powertools

This is a pre-owned Hall Surgairtome Two 5058-01 high speed drill.

It runs at 90,000rpm at 90-110psi and is ideal for all precision cutting and sculpting of bone and/or enamel in wet surgery. It has an angled swivel hose connector for comfort and instant stop/start of the drill function on release of the switch. Premium equipment, fully refurbished.

Order Code	Description	RRP
PT-SURG-SET	Halls Surgairtome Two including Burr, Drill, Long Burr Guard and Hose	£2,500.00

Warranty is 3 months excluding misuse.



The K200 Minidriver set is perfect for small bone procedures in veterinary theatres. It is robust, easy to use and cheap to maintain.

Order Code	Description	RRP
PT-K200-SET	K200 SET including Minidriver Handpiece, K220 Sagittal Saw, K109 Jacobs Chuck Large, K110 Jacobs Chuck Small, K111A Wire Driver, K114 AO QC, 3M Hose	£3,600.00

Preowned Battery Set

CONMED Full Kit

Order Code	Description	RRP
PT-CMD-FULL-SET	Set contains: 1 x Conmed PRO3600 Universal Battery Charger 4 x Conmed PRO3020 Sealed Battery 1 x Conmed PRO6200 M-Power Multi Driver Handpiece 1 x Conmed PRO6300 M-Power Sagittal Saw Handpiece 1 x Conmed PRO6400 M-Power Reciprocating Saw Handpiece 1 x Conmed PRO6232 Pin Driver Attachment 1 x Conmed PRO6128 Wire Driver Attachment 1 x Conmed PRO2041 Jacobs Drill Attachment with Key 1 x Conmed PRO2038 AO Quick Release Drill Chuck Attachment 1 x Conmed PRO2029 Trinkle Drill/Reamer Attachment 1 x Conmed PRO2046 Hudson/Zimmer Reamer Attachment	£9,925.00



CONMED PRO6150 Pneumatic Kit

Order Code	Description	RRP
PT-CON-PN-SET	Multi-Driver Handpiece Sagittal Saw Handpiece Reciprocating Saw Attachment AO Drill Quick Release Attachment Small Jacobs Chuck Attachment Hudson Reamer Attachment Pin Driver Attachment Wire Driver Attachment (Not Shown) Hall Air Hose	£4,450.00



STRYKER CD4 Small Battery Kit

Order Code	Description	RRP
PT-STYK-CD4-SET	Stryker CD4 Handpiece Sagittal Saw Attachment Pin Collet Wire Collet Large Jacobs Chuck Attachment Small Jacobs Chuck Attachment AO Drill Quick Release Attachment Stryker Compatible Battery x 2 Stryker Compatible Battery Case x 1 Battery Transfer Shield x 1 Single Unit Battery Charger	£7,090.00



Tabletop Sterilisers



Midmark Tabletop Sterilisers

Reliable:

Midmark sterilisers last longer due to top quality components made in Europe.

Perfect for your needs:

18, 23 and 60 litres chambers are made of thick one-piece moulded AISI 304 steel.

Trouble Free:

Intelligent self-checking system alerts about maintenance needs.

Efficient:

Pre-set validated sterilisation programs.

Safe:

Multiple sensors check working parameters adapting cycle times to internal and external conditions.

Accurate:

The integrated water quality sensor constantly monitors the water quality. Only good quality water ensures a perfect sterilisation and long life for your instruments and autoclave.

Simple:

Easy to use by everyone, easy to service

Order Code	Description	RRP
AU-CL-18-B	Vetassure Autoclave 18L B Class Autoclave	£3,650.00
AU-CL-23-B	Vetassure Autoclave 23L B Class Autoclave	£4,150.00
AU-CL-60-B	Vetassure Autoclave 60L B Class Autoclave	£10,999.00
AU-CL-18-S	Vetassure Autoclave 18L S Class Autoclave	£3,180.00
AU-CL-23-S	Vetassure Autoclave 23L S Class Autoclave	£3,660.00

Price includes delivery and installation by engineer. Staff training at time of installation - 2 years/2000 cycles.

Warranty labour and parts and pre site survey.



Door Locking:

Motor operated door locking guarantees total safety, greater ease of handling and reliable self regulation of the door.



Water Quality Sensor:

Our sterilisers are additionally protected by the inclusion of a water quality sensor, as standard. The quality of the water is therefore constantly monitored. The display informs the user whether water used for sterilisation is good.



Usb Port:

Automatic digital cycle recording on USB stick can be downloaded on your PC using our proprietary software (optional).



User Friendly Interface:

Just four buttons keypad for simple navigation to all sterilisation options. The LCD display shows current information about your sterilisation cycles and alerts on errors or service needs.



Built-In Thermal Printer:

An automatic print-out records the entire procedure, thereby providing a permanent record of every sterilisation cycle. The paper printout can then be kept and attached to your files for a complete and accurate record.



Start Delay - Option Extra Drying - Option

Cycle options available in the user menu.

- Capacity 60 litres
- Built-in osmotic system
- Double vacuum pump
- Double motor-operated locking system
- Integrated USB storage device
- On board printer
- Additional drying option
- « Start delay » option
- B/S/N-class cycles included
- Single phase B60 option
- Three phase B60 steam injection option

MIDMARK VET ASSURE 18L

RECOMMENDED CYCLES

- Cycle designed to sterilize wrapped material
- Cycle suitable for sterilising UNWRAPPED MATERIALS only

TEMP AND NAME OF CYCLE	STERILISABLE LOADS ¹	TECHNICAL SPECS OF THE CYCLES ²			
		STRD	RY	TO TK	G
134° B Helix - B&D Test	Steam Penetration Test	●	03:30	04:00	~25m 0
- Vacuum Test	Leak Detection Test	●	-	-	~15m 0
121° B Hollow Wrapped	Solid load, small porous objects, simple hollow load and narrow lumen, multiple casing	●	18:00	15:00	~50m 2.5
134° B Hollow Wrapped		●	10:00	15:00	~44m 2.5
121° B Porous	Full porous load	●	18:00	20:00	~57m 1.0
134° B Porous		●	15:00	20:00	~50m 1.0
134° B Prion	Load related to the Creutzfeldt-Jakob disease	●	20:00	15:00	~54m 2.5
134° S Rapid	Solid load, small porous objects, simple hollow load	●	05:00	10:00	~42m 4.0

B-CLASS

TEMP AND NAME OF CYCLE	STERILISABLE LOADS ¹	TECHNICAL SPECS OF THE CYCLES ²			
		STRD	RY	TO TK	G
134° S Bowie & Dick Test	Steam Penetration Test	●	03:30	04:00	~28m 0
- Vacuum Test	Leak Detection Test	●	-	-	~15m 0
121° S Hollow Wrapped	Solid load, small porous objects, simple hollow load	●	18:00	15:00	~51m 1.5
134° S Hollow Wrapped		●	10:00	15:00	~45m 1.5
121° S Porous	Small sized porous load	●	18:00	20:00	~61m 0.5
134° S Porous		●	15:00	20:00	~60m 0.5
134° S Prion	Load related to the Creutzfeldt-Jakob disease	●	20:00	15:00	~55m 1.5
134° S Rapid	Solid load, small porous objects, simple hollow load	●	05:00	10:00	~41m 2.5

S-CLASS

¹ To select the sterilisation cycle, always refer to the indications of the manufacturer of the instrument /load to be sterilised.
² Please note that, although the total times indicated in the table have been obtained by trying to simulate the "worst" autoclave conditions, changes to the times indicated are possible: power supply, cycle start temperature, weight of the inserted loads and other factors have an impact on the total duration of the cycle.

MIDMARK VET ASSURE 23L

RECOMMENDED CYCLES

- Cycle designed to sterilize wrapped material
- Cycle suitable for sterilising UNWRAPPED MATERIALS only

TEMP AND NAME OF CYCLE	STERILISABLE LOADS ¹	TECHNICAL SPECS OF THE CYCLES ²			
		STRD	RY	TOT	KG
134° B Helix - B&D Test	Steam Penetration Test	●	03:30	04:00	~35m 0
- Vacuum Test	Leak Detection Test	●	-	-	~15m 0
121° B Hollow Wrapped	Solid load, small porous objects, simple hollow load and narrow lumen, multiple casing	●	18:00	15:00	~60m 3.5
134° B Hollow Wrapped		●	10:00	15:00	~54m 3.5
121° B Porous	Full porous load	●	18:00	20:00	~67m 1.5
134° B Porous		●	15:00	20:00	~60m 1.5
134° B Prion	Load related to the Creutzfeldt-Jakob disease	●	20:00	15:00	~64m 3.5
134° S Rapid	Solid load, small porous objects, simple hollow load	●	05:00	10:00	~52m 4.5

B-CLASS

TEMP AND NAME OF CYCLES	STERILISABLE LOADS ¹	TECHNICAL SPECS OF THE CYCLES ²			
		STRD	RY	TOT	KG
134° S Bowie & Dick Test	Steam Penetration Test	●	03:30	04:00	~28m 0
- Vacuum Test	Leak Detection Test	●	-	-	~15m 0
121° S Hollow Wrapped	Solid load, small porous objects, simple hollow load	●	18:00	15:00	~61m 2.5
134° S Hollow Wrapped		●	10:00	15:00	~55m 2.5
121° S Porous	Small sized porous load	●	18:00	20:00	~71m 1.0
134° S Porous		●	15:00	20:00	~70m 1.0
134° S Prion	Load related to the Creutzfeldt-Jakob disease	●	20:00	15:00	~65m 2.5
134° S Rapid	Solid load, small porous objects, simple hollow load	●	05:00	10:00	~51m 2.5

S-CLASS

¹ To select the sterilisation cycle, always refer to the indications of the manufacturer of the instrument /load to be sterilised.
² Please note that, although the total times indicated in the table have been obtained by trying to simulate the "worst" autoclave conditions, changes to the times indicated are possible: power supply, cycle start temperature, weight of the inserted loads and other factors have an impact on the total duration of the cycle.

MIDMARK 60 L

TEMP AND NAME OF CYCLE	STERILISABLE LOADS ¹	TECHNICAL SPECS OF THE CYCLES ²			
		STRD	RY	TO T	KG
134° B Helix - B&D Test	Steam Penetration Test	●	03:30	04:00	~75m ~ 45m 0
-V Vacuum Test	Leak Detection Test	●	-	-	15m 0
121° B Hollow Wrapped	Solid load, small porous objects, simple hollow load and narrow lumen, multiple casing	●	20:00	15:00	~140m ~90m
134° B Hollow Wrapped		●	05:00	15:00	~135m ~85m
121° S Solids Wrapped	Solid load, small porous objects, simple hollow load	●	20:00	15:00	~125m ~75m
134° S Solids Wrapped		●	05:00	15:00	~120m ~60m
134° B Prion	Load related to the Creutzfeldt-Jakob disease	●	20:00	15:00	~150m ~90m
134° B Porous	Full porous load	●	05:00	25:00	~160m ~110m 6.0
134° N Solids Open	Solid load	●	05:00	15:00	~105m ~90m 12.0





Recessed units not shown

QuickClean™ Ultrasonic Cleaner

POWERFUL CLEANING – CONSISTENT RESULTS

Providing powerful, effective cleaning and consistent results, the QuickClean Ultrasonic Cleaner is a piece of equipment your dental office can't be without. The QuickClean's cutting-edge technology can help you create a safer, more efficient work environment by decreasing worker exposure to contaminants and potential sharps injuries while reducing the time and effort needed for cleaning.

- 150% more effective than Soniclean
- Customized cycle times from 1-99 minutes
- Full-size safety basket included
- 3-year limited warranty

LEAP



Powerful Technology

The QuickClean unit cleans thoroughly and consistently throughout the entire bath using Frequency-Leap technology. This advancement in cleaning efficiency helps ensure all of your instruments are fully cleaned the first time, every time, no matter where they are placed in the basket.

Simple to Operate

The QuickClean is easy to use right out of the box, so you can get your staff up and running with minimal training time. Features like a digital LCD control panel that displays prompts, options for preset or customized settings, intelligent software that remembers the last cycle settings, and a fluid sensor that ensures the bath always has sufficient water levels help simplify your processes and increase productivity.

Range of sizes and design options

The QuickClean comes in three table top sizes (1.2, 3.3 and 6.6 gal) and two recessed options (3.3 and 6.6 gal), so you can choose the option that best fits your configuration and workflow. And the stainless steel finish and attractive design coordinate well with any décor.



Order Code	Description	RRP
UC-QC1-4.5	Quickclean 4.5L Ultra Sonic Cleaner, Includes Delivery	£1,350.00
UC-QC3-12.5	Quickclean 12.5L Ultra Sonic Cleaner, Includes Delivery	£1,700.00
UC-QC6-25	Quickclean 25L Ultra Sonic Cleaner, Includes Delivery	£2,200.00

Capacity

4.5 / 12.5 / 25 L

Dimensions (H x W x D)

265 x 345 x 260 mm
 265 x 375 x 420 mm
 365 x 550 x 420 mm

Tank size (H x W x D)

150 x 300 x 150 mm
 150 x 330 x 300 mm
 200 x 505 x 300 mm

Weight

5.76 Kg (empty)
 8.42 Kg
 13.44 Kg

Arthroscopy set

Veterinary Supplies

Veterinary Arthroscopy Set

- 01** Alligator Grasping Forceps
Length = 12.0 cm, 2.0 mm
- 02** Alligator Grasping Forceps
Length = 12.0 cm, 2.7 mm
- 03** Universal Rongeur and Grasping Forceps
Length = 12.0 cm, 2.0 mm
- 04** Universal Rongeur and Grasping Forceps
Length = 12.0 cm, 2.7 mm
- 05** Hooked Scissor Straight
Length = 12 cm, 2.7 mm
- 06** Knee Retractor with PTFE Handle
Length = 28.0 cm, Tip = 1.5 mm
- 07** Spoon Curette
Length = 20.0 cm
- 08** Head Burr
Length = 19.3 cm, Tip = 2.3 mm
- 09** Probe
Length = 20.0 cm, Tip = 1.0 mm
- 10** Meniscus Knife
Length = 20.0 cm
- 11** Banana Knife
Length = 20.0 cm
- 12** Gordon Coronoid Osteotome
Size = 2 mm
- 13** Gordon Coronoid Osteotome
Size = 4 mm
- 14** Meniscus Push Knife Knurled
Length = 22.0 cm, Tip = 2.0 mm
- 15** Meniscus Hook Knife Knurled
Length = 22.0 cm, Tip = 2.0 mm
- 16** Manicus Probe
Length = 22.0 cm, Tip = 2.0 mm
- 17** Curette with hole
Length = 20.0 cm, Tip = 2.3 mm
- 18** Biopsy Forceps with 4 detachable tips
Tip 1 = Ø 2.7 mm
Tip 2 = Ø 3.5 mm
Tip 3 = 5 x 2.7 mm
Tip 4 = 5 x 3.7 mm
- 19** Small Joint Distractor
Length = 10.0 cm, Tip Dia. = 3 mm
- 20** Trocar Set
Size = 2.2 mm / 2.8 mm / 3.5 mm / 4.2 mm
- 21** Trocar Set
- 22** Arthroscopy Trocars
Length = 7.0 cm, Ø 3.5 mm
- 23** Arthroscopy Trocars
Length = 7.0 cm, Ø 4.5 mm
- 24** Arthroscopic Distractor
Max. Pin Dia. = 3.2 mm For JIG PIN
- 25** Marking Rod
Length = 20.0 cm, 2.1 mm

We have launched a new full arthroscopy kit that will cover most of your instrument needs. All kept together in the stainless steel box it offers great value. All the instruments are also available separately.

RRP
£3500
OFFER PRICE
£3000



- www.n2-uk.com
- +44 (0)23 9323 3265
- @n2ukcom
- www.facebook.com/n2ukltd
- sales@n2-uk.com
- office@n2-uk.com for orders

Multiparameter Monitor

The Midmark Multiparameter Monitor is designed with the tools to help you provide safer, more efficient care.

Designed for safer, more efficient procedures

With decades of clinical experience responding to common anaesthetic issues, we have designed enhanced features to help your team avoid pitfalls and prevent anaesthetic complications. In addition, the Midmark Multiparameter Monitor features Cardell® blood pressure technology, veterinary specific algorithms, and innovative, staff-friendly capabilities.

Pre-procedure checklist + soda lime reminder

As a veterinary professional, your day can be extremely demanding. With the new pre-procedure checklist and CO₂ soda lime absorbent reminder, you can feel at ease knowing everyone in your practice is taking the necessary steps for safe and efficient procedures.

Enhanced BP features

The Cardell® BP technology you have grown to trust adapts to your patient and employs advanced motion suppression for more efficient, reliable and timely readings. An additional screening mode allows for more accurate diagnostic readings on awake patients.

ECG + CO₂ library

The new waveform library shows the most common patterns you'll find in anaesthetic cases, which can help you confidently and quickly make an informed decision to move a procedure forward. When you see a waveform that doesn't look normal, you can quickly - with one touch-scroll to match patterns of common anaesthetic occurrences from tachycardias to VPCs and airway obstructions to hypercapnia. Being able to quickly compare waveforms eliminates some of the guesswork in identifying possible problems - major or minor - and often results in better patient outcomes.



Midmark Multiparameter Monitor Specifications

Non-Invasive Blood Pressure (NIBP)	Cardell® Technology
Pulse Oximetry (SpO ₂)	Nellcor® Oximax®
CO ₂	Respironics C-STAT5 Mainstream Respironics LoFlo Sidestream
ECG	3-Lead Standard 5-Lead Optional
HR/PR	ECG HR/SpO ₂ and NIBP PR
Temperature	2-Channel
Respiration Method	Indirect: Impedance Direct: Capnography (optional)
Invasive Blood Pressure	2-Channel (optional)
Anaesthetic Gas	Masimo® Multigas Mainstream or Sidestream (optional) CO ₂ , N ₂ O, ISO, SEV, ENF, DES, HAL
Display	12.1" LCD Resistive Touch Screen
Waveform Display	6-Channel with IBP and Multigas Options 3-4 Channel Standard Display
ECG Vector Wave Form Display	7-Channel with 5-Lead Option 1-Channel with 3-Lead Option
ECG Gain	Auto, x0.25, x0.5, x1, x2, x4
HR/PR Range	ECG HR = 15–350 bpm SpO ₂ PR = 20–300 bpm
NIBP Modes	Manual, Auto, Continuous, Screen
Parameter Alarms	User-Defined High/Low with 4 Defaults (Cat, Dog, Horse, Other)
Download to PC	USB Drive
Weight	9.2 LB (Monitor with Battery)
Battery Life	Up to 10 Hours
Limited Warranty	2 Years, limited

Order Code	Description	RRP
MON-MTP-PR	Midmark Multiparameter Monitor with Printer	£ POA
MON-MTP-NP	Midmark Multiparameter Monitor without Printer	£ POA
MON-MTP-PR-BP	Midmark Multiparameter Monitor with Printer and Invasive BP	£ POA

Opticlar Medical Diagnostic Instruments



OPT-DIA-SET-STD-2H-LITH

Standard Veterinary Diagnostic Set with 2 x ADAPT lithium handles and twin port charger

- LED Veterinary Slit Otoscope with 3x swivelling magnification
- LED L28 veterinary ophthalmoscope with cobalt blue filter, light sensitive filter and 5 apertures
- 3 x metal tips; 1 each of 57.0 x 4.0mm, 65.0 x 6.0mm, 90.0 x 7.0mm
- 2 x ADAPT Lithium ion handles and desk charger with unique Auto On/Auto Off facility that automatically switches handle off when located in charger and switches on when removed
- Storage case

Order Code	Description	RRP
OPT-DIA-SET-STD-2H-LITH	Opticlar Veterinary Diagnostic Set (Otoscope, ophthalmoscope and Metal Tips) with 2 ADAP Lithium Handles and Twin Charger	£857.00

OPT-DIA-SET-STD-1H-LITH

Standard Veterinary Diagnostic Set with 1 x ADAPT lithium handle and single port charger

Order Code	Description	RRP
OPT-DIA-SET-STD-1H-LITH	Opticlar Veterinary Diagnostic Set (Otoscope, ophthalmoscope and Metal Tips) with 1 ADAP Lithium Handles and Single Charger	£780.00



OPT-DIA-SET-STD-CCELL

Standard Veterinary Diagnostic Set with ADAPT C cell handle

- LED Veterinary Slit Otoscope
- LED L28 veterinary ophthalmoscope with cobalt blue filter, light sensitive filter and 5 apertures
- 3 x metal tips: 1 each of 57.0 x 4.0mm, 65.0 x 6.0mm, 90.0 x 7.0mm
- C Cell battery handle
- Storage case

Order Code	Description	RRP
OPT-DIA-SET-STD-CCELL	Opticlar Veterinary Diagnostic Set with C Cell Battery Handle	£585.00

OPT-DIA-SET-STD-2H-ELITH

Standard Veterinary Diagnostic Set with 2 x E lithium handles and twin port charger

- LED Veterinary Slit Otoscope
- LED L28 veterinary ophthalmoscope with cobalt blue filter, light sensitive filter and 5 apertures
- 3 x metal tips: 1 each of 57.0 x 4.0mm, 65.0 x 6.0mm, 90.0 x 7.0mm
- 2 x E lithium modular handles
- Twin port desk charger
- Storage case



Order Code	Description	RRP
OPT-DIA-SET-STD-2H-ELITH	Opticlar Standard Diagnostic Set (Otoscope, ophthalmoscope and Metal Tips) with 2 E Lithium Handles and Twin Charger	£909.00



OPT-DIA-SET-STD-WALL

Standard Veterinary Diagnostic Set - Wall Mounted - Mains and C cell with Stainless Steel Tip Tidy

- LED Veterinary Slit Otoscope with Stainless Steel Tip Tidy
- LED L28 veterinary ophthalmoscope with cobalt blue filter, light sensitive filter and 5 apertures
- 3 x metal tips: 1 each of 57.0 x 4.0mm, 65.0 x 6.0mm, 90.0 x 7.0mm
- Mains and C cell powered wall unit with twin spiral cord handles

Order Code	Description	RRP
OPT-DIA-SET-STD-WALL	Opticlar Wall Mounted Mains Power Diagnostic Set (Otoscope, ophthalmoscope and Metal Tips)	£792.00

OPT-OTO-LAR-SET-MILLER

Prep Room Set 2 - with Vet Miller Straight Blade and LED Vet Slit Otoscope. Ideal set for small animal based practice. Can be used for ear irrigation, foreign body removal, inspection and diagnosis as well as intubation.

Prep Room Set 2 contents:

- Miller Sz.2 veterinary blade
- Lithium Ion rechargeable LED laryngoscope handle
- LED veterinary slit otoscope
- 4 x multipurpose tips
2 x open tips for intubation and seed removal
1 x long closed tip with cutout and
1 x long closed tip
- Twin port charger



Order Code	Description	RRP
OPT-OTO-LAR-SET-MILLER	Opticlar Otoscope Laryngoscope Vet Set with Miller Straight Blade and Twin Charger	£1,010.00

OPT-OTO-LAR-SET-MAC

Prep Room Set 2A - with Vet Macintosh Curved Blade and LED Vet Slit Otoscope. Ideal set for small animal based practice and can be used for ear irrigation, foreign body removal, inspection and diagnosis as well as intubation.

Prep Room Set 2 contents:

- Mac Sz2 curved veterinary blade
- Lithium Ion rechargeable LED laryngoscope handle
- LED veterinary slit otoscope
- 4 x multipurpose tips
2 x open tips for intubation and seed removal
1 x long closed tip with cutout and
1 x long closed tip
- Twin port charger



Order Code	Description	RRP
OPT-OTO-LAR-SET-MAC	Opticlar Otoscope Laryngoscope Vet Set with Macintosh Curved Blade and Twin Charger	£1,010.00



OPTICLAR VISIONMAG Pro-Line I.O Loupes

With a twin lens system the Pro-Line range of loupes provide excellent edge to edge clarity with no aberration. The individually adjustable optics ensure accurate interpupillary setting. Coated optics minimise reflections and maximise light transmission to provide crisp bright images. The unique height adjuster provides perfect pupillary alignment. The extreme angles of declination available ensures that these loupes are ideal for dentistry as well as all other forms of examination, other disciplines and surgery. Very comfortable, lightweight yet strong sports frame.

Order Code	Magnification	Working Distance mm
402.025.340	2.5x	340
402.025.420	2.5x	420
402.025.460	2.5x	460
402.025.500	2.5x	500
402.030.340	3.0x	340
402.030.420	3.0x	420
402.030.460	3.0x	460
402.030.500	3.0x	500

Order Code	Description	RRP
OPT-LOUPE-25-340	Vision Mag Pro-Line I.O Loupes 2.5x Magnification 340mm Working Distance	£550.00
OPT-LOUPE-25-420	Vision Mag Pro-Line I.O Loupes 2.5x Magnification 420mm Working Distance	£550.00
OPT-LOUPE-25-460	Vision Mag Pro-Line I.O Loupes 2.5x Magnification 460mm Working Distance	£550.00
OPT-LOUPE-25-500	Vision Mag Pro-Line I.O Loupes 2.5x Magnification 500mm Working Distance	£550.00
OPT-LOUPE-30-340	Vision Mag Pro-Line I.O Loupes 3.0x Magnification 340mm Working Distance	£550.00
OPT-LOUPE-30-420	Vision Mag Pro-Line I.O Loupes 3.0x Magnification 420mm Working Distance	£550.00
OPT-LOUPE-30-460	Vision Mag Pro-Line I.O Loupes 3.0x Magnification 460mm Working Distance	£550.00
OPT-LOUPE-30-500	Vision Mag Pro-Line I.O Loupes 3.0x Magnification 500mm Working Distance	£550.00

Opticlar VisionMax Mini LED Headlight

The VisionMax Mini LED Headlight has been designed to provide the brightest, sharpest illumination field from the lightest and most compact light source. With a head-mounted light, it is ideal when the user barely notices the light is there and appreciates the benefits of a perfectly lit examination / operating field without the distraction and discomfort of a visible, heavier light. That is certainly true with the VM Mini headlight.

Illumination is provided by the 3watt TrueTone™ LED, with even illumination throughout the field of view and edge-to-edge clarity with no visible aberration or distortion. TrueTone™ LED provides the brightest light, whilst retaining the natural characteristics of the image.

- VM Mini - micro in size and micro in weight
- Articulated mounting and adjustable light position
- Available with a choice of Lightweight sports style or Professional headband providing extra cranial support
- Powered by Lithium-Ion rechargeable battery pack, in a choice of:
 - Wireless, with headband mounted battery pack (Pro headband only)
 - Waist-worn with belt clip
- TrueTone™ LED illumination, with 10 year warranty (typical life >20,000 hours)



Order Code	Description	RRP
OPT-LIGHT-MINI	Vision Max Mini LED Headlight Pro Wireless	£901.00
OPT-LIGHT-MINI-WP	Vision Max Mini LED Headlight Pro with Waistband Powerpack	£681.00
OPT-LIGHT-MINI-WP-SH	Vision Max Mini LED Headlight with Waistband Powerpack and Sports Headband	£637.00

Surgical Theatre Equipment

GIMA 28281 'A-Speed 2' Double Pump Suction

This is a GIMA 28281 suction unit. It is easy to use, lightweight, powerful and quieter than most alternatives.

Order Code	Description	RRP
PT-SUC-DB	GIMA 28281 'A-Speed 2' Double Pump Suction Unit	£360.00



Gima 30450 Smoke Evacuator / Air Purifier - KIT

The GIMA 30450 smoke evacuator removes airborne toxins caused by diathermy operations, bacteriological and viral risks, and improves visibility during laparoscopy.

Available as a unit without the accessory pack.

Order Code	Description	RRP
PT-SMK-EVAC	Gima 30450 Smoke Evacuator / Air Purifier - KIT	£1,960.00



GIMA 80805 SP-20 Handheld Vet Pulse Oximeter

This GIMA 80805 SP-20 handheld pulse oximeter is lightweight, easy to use and can simultaneously measure SpO2 and pulse rate by clipping the sensor to the tongue, leg, ear or tail.

Supplied with universal "Y" type SpO2 probe and 2 adapters: big and small clip for different measuring, orange rubber cover, charging base and user manual (GB, IT).

Order Code	Description	RRP
PT-PUL-OX-HH	GIMA 80805 SP-20 Handheld Vet Pulse Oximeter	£220.00



Two Stage Adjustable Surgical Air Regulator With UK MA-7 Schrader (Bullnose)

This is a premium quality two-stage medical air regulator with adjustable pressure for 0-10 bar power delivery. With bullnose tank connector and MA-7 compatible schrader connector, for UK surgical air powered equipment.

Order Code	Description	RRP
PT-REG-MA7-S	Two Stage Adjustable Surgical Air Regulator With UK MA-7 Schrader (Bullnose)	£515.00



Diathermy Units



The Gima MB122 is an HF electrosurgery unit ideal for performing middle monopolar or bipolar electrosurgery. One of the most robust units on the market.



The Gima MB 160D is an HF electrosurgery unit ideal for performing middle monopolar or bipolar electrosurgery and ideal for damp operational fields such as internal and orthopaedic surgery. Digital control now increases the precision of electrical output.



This is a reusable GIMA 30320 electrosurgery artery sealer, compatible with the MB120 and MB160D units and measures 26cm in length.

Requires compatible cable 30325 and bipolar adapter 30642 to function.



These are reusable GIMA 30310 electrosurgery scissors, compatible with the MB120 and MB160D units and measures 18cm in length (7").

Requires compatible cable 30315 and bipolar adapter 30642 to function.



Order Code	Description	RRP
DIA-MB122-SET	Gima MB122 Diathermy Unit (includes cables, electrodes and fingerswitch)	£1,600.00
DIA-MB160D-SET	Gima MB160D Diathermy Unit (includes cables, electrodes and fingerswitch)	£1,950.00
DIA-ART-SEAL-HP	Artery Sealer Handpiece	£400.00
DIA-ART-SEAL-CB	Artery Sealer Cable	£100.00
DIA-BP-SCISS	Bipolar Scissors	£350.00
DIA-BP-SCISS-CB	Cable for Bipolar Scissors	£100.00

Bone Model Training aids

Having client compliance goes a long way in them agreeing to put their pet through surgery and in them sticking to your post op instructions.

Owners allowing their pets to do more than you recommended is a big part of implant failures.

We are working with a 3D printing company to offer these anatomically perfect bone models to help show your clients exactly the problem and what you intend to do to rectify it. This leads to a better understanding for the clients and even though their beloved pet is walking fine the day after the surgery that's more down to the success of the surgery rather than the unexpected quickness of the repair.

Anatomical models are also an indispensable aid in planning and preparing for complex surgical procedures such as corrective osteotomies, spinal surgeries or multi-fragment long bone fracture fixation surgeries, where it is crucial to achieve the optimal relative alignment of the major proximal and distal bone fractures. Careful planning of the surgery and its practice by cutting the model allow you to shorten the duration of the procedure itself by up to 30%.

Listed below are a few of the range

Order Code	Description	RRP
BM-HUM-CAN-L	Humerus - Canine - M - LEFT	£32.00
BM-HUM-CAN-R	Humerus - Canine - M - RIGHT	£32.00
BM-RADUL-CAN-L	Radius and Ulna - Canine - M - LEFT	£53.00
BM-RADUL-CAN-R	Radius and Ulna - Canine - M - RIGHT	£53.00
BM-PEL-CAN	Pelvis - Canine - M	£55.00
BM-FEM-CAN-L	Femur - Canine - M - LEFT	£32.00
BM-FEM-CAN-R	Femur - Canine - M - RIGHT	£32.00
BM-TIB-CAN-L	Tibia - Canine - M - LEFT	£32.00
BM-TIB-CAN-R	Tibia - Canine - M - RIGHT	£32.00
BM-TIBFIB-CAN-L	Tibia and Fibula - Canine - M - LEFT	£32.00
BM-TIBFIB-CAN-R	Tibia and Fibula - Canine - M - RIGHT	£32.00
BM-PELV-FL	Pelvis - Feline	£34.00
BM-PELVSAC-F	Pelvis with Sacrum - Feline	£34.00
BM-STIF-CAN-L	Full Stifle Joint - LEFT	£99.00
BM-STIF-CAN-R	Full Stifle Joint - RIGHT	£99.00
BM-STIF-CAN-TPLO-L	Full Stifle Joint with Radial Cut - LEFT	£99.00
BM-STIF-CAN-TPLO-R	Full Stifle Joint with Radial Cut - RIGHT	£99.00
BM-STIF-CAN-CCWO-L	Full Stifle Joint with Closing Wedge Cut - LEFT	£99.00
BM-STIF-CAN-CCWO-R	Full Stifle joint with Closing Wedge Cut - RIGHT	£99.00

The bones are 3D printed and will not melt when drilling or cutting.

The fracture models are equipped with flat flexible connectors making it possible to use bone plates directly on them



Absorbable Haemostatic Agent

We are pleased to introduce our latest product SMI-CEL, a highly effective absorbable haemostatic agent made from oxidised regenerated cellulose (ORC).

SMI-CEL is used as an adjunct to surgical procedures to assist in the control of capillary, venous and small arterial bleeding when ligation or other conventional control methods are impractical or ineffective.

In addition, SMI-CEL has been shown to be bactericidal against a broad spectrum of aerobic and anaerobic pathogens, increasing its therapeutic potential in clinical practice. By reducing operating time and complications, the success of the surgical procedure is ultimately optimised.



SMI-CEL Standard

- Structure: Woven structure.
- Features: Ideal for covering flat or slightly contoured surfaces. It is flexible and can be cut to the desired size.
- Applications: For general surgical procedures where a flat surface is required to cover a bleeding area, e.g. B. general surgery, abdominal surgery and superficial wounds.

Order Code	Description	RRP
AH-CEL-STD-125-5	Absorbable Haemostatic Agent 1.25cm x 5cm (Pack 12) rrp	£50.00
AH-CEL-STD-5-75	Absorbable Haemostatic Agent 5cm x 7.5cm (Pack 12) rrp	£95.00
AH-CEL-STD-51-356	Absorbable Haemostatic Agent 5.1cm x 35.6cm (Pack 12) rrp	£185.00
AH-CEL-STD-75-10	Absorbable Haemostatic Agent 7.5cm x 10cm (Pack 12) rrp	£135.00
AH-CEL-STD-10-20	Absorbable Haemostatic Agent 10cm x 20cm (Pack 12) rrp	£195.00



SMI-CEL Knit

- Structure: Knitted with a dense weave structure.
- Features: Offers better adaptability and flexibility than SMI-CEL Standard. Easily adapts to irregular surfaces and cavities.
- Applications: Ideal for hard-to-reach areas or complex geometries, e.g. B. during orthopedic procedures or deep wounds.

Order Code	Description	RRP
AH-CEL-KNIT-26-26	Absorbable Haemostatic Agent 2.6cm x 2.6cm (Pack 12)	£80.00
AH-CEL-KNIT-76-102	Absorbable Haemostatic Agent 7.6cm x 10.2cm (Pack 12)	£210.00
AH-CEL-KNIT-152-229	Absorbable Haemostatic Agent 15.25cm x 22.9cm (Pack 12)	£465.00
AH-CEL-KNIT-102-102	Absorbable Haemostatic Agent 10.2 x 10.2cm (Pack 12)	£495.00



SMI-CEL Fibrillar

- Structure: Made of loose fibrous material.
- Features: Has a larger surface area, which can improve haemostatic properties. Easily tears into small pieces and conforms to irregular surfaces.
- Applications: Suitable for insertion into cavities or wounds where a more absorbent material is required. It is often used in dentistry and to stop bleeding in areas of high blood flow.

Order Code	Description	RRP
AH-CEL-FIB-26-51	Absorbable Haemostatic Agent 2.6cm x 5.1cm (Pack 12)	£90.00
AH-CEL-FIB-51-102	Absorbable Haemostatic Agent 5.1cm x 10.2cm (Pack 12)	£185.00
AH-CEL-FIB-102-102	Absorbable Haemostatic Agent 10.2cm x 10.2cm (Pack 12)	£230.00



Spinnaker Premium TPLO Implant Kit



To complement our quality Spinnaker TPLO plate range (in our Implant catalogue) we are launching our new complete Spinnaker Premium TPLO Implant Kit.

Made of an anodised aluminium block it has been designed to fit all the implants you would need to use, any size of our Spinnaker TPLO plate range. Two of each size plate can be carried in the kit and the clear markings make it easy for it to be restocked after your procedures. For Spinnaker TPLO plates see page 164 of the implant catalogue.

Both cortical and locking screws fit side by side and are easily reachable by driver.

The lid ensures the screws are held tightly in place during storage.

The rack is designed to fit in our premium storage boxes meaning there is no wrapping needed to sterilise the kits. Once sterilised they will remain sterile for up to 12 months whilst the lid remains down meaning they are a great way to reduce your practice carbon footprint. We offer a few kit options to suit your needs.

Order Code	Description	Component RRP	Offer	SAVING
PM-RACK-TPLO-IMP-MP	Victory Rack Full of Screws Drill Guides and One of Each Monoaxial Proximal Hole Spinnaker Plate	£5,842	£5,000	£842
PM-RACK-TPLO-IMP-PP	Victory Rack Full of Screws Drill Guides and One of Each Polyaxial Proximal Hole Spinnaker Plate**	£5,842	£5,000	£842

The implant kit comprises:

- Victory Premium TPLO Tray
- Premium Storage Box
- 2.0mm Cortical Torx Screws 6mm-20mm
- 2.4mm Cortical Torx Screws 8mm-28mm
- 2.7mm Cortical Torx Screws 10mm-30mm
- 3.5mm Cortical Torx Screws 14mm-36mm
- 2.0mm Locking Torx Screws 6mm-20mm
- 2.4mm Locking Torx Screws 8mm-28mm
- 2.7mm Locking Torx Screws 10mm-30mm
- 3.5mm Locking Torx Screws 14mm-36mm
- 2.0-3.5mm Locking Drill Guides
- One of Each Spinnaker TPLO Plate (L and R) 2.0, 2.4, 2.7, 3.5 Small, 3.5 and 3.5mm Broad



 www.n2-uk.com

 +44 (0)23 9323 3265

 @n2ukcom

 www.facebook.com/n2ukltd

 sales@n2-uk.com

 office@n2-uk.com for orders



Spinnaker Premium Complete TPLO Kit



You can also purchase a complete kit including the instruments required in an autoclavable box.

Order Code	Description	Component RRP	Offer	SAVING
PM-KIT-TPLO-MP-FULL	Victory Kit Complete with Instruments and Storage Box – Monoaxial Proximal Hole	£7,453	£6,000	£1,453
PM-KIT-TPLO-PP-FULL	Victory Kit Complete with Instruments and Storage Box – Polyaxial Proximal Hole**	£7,453	£6,000	£1,453

The complete kit offers everything listed overleaf, plus:

- Premium Storage Box
- Premium AO Handle
- Screwdriver Tips for T6, T8 and T15 Screws
- Drill Bits 1.8, 2.0, 2.5 and 2.7mm
- Load/Neutral Drill Guides 2.0, 2.4, 2.7 and 3.5mm



***Rent this full kit for £200 for the week.**
Price includes shipping and return shipping.
Implants used will be charged out afterwards.

www.n2-uk.com

+44 (0)23 9323 3265

@n2ukcom



www.facebook.com/n2ukltd



sales@n2-uk.com



office@n2-uk.com for orders



N2 (UK) Ltd



CATALOGUES



Veterinary Supplies

Want a copy of all our current catalogues?
use the QR code for instant access to them all

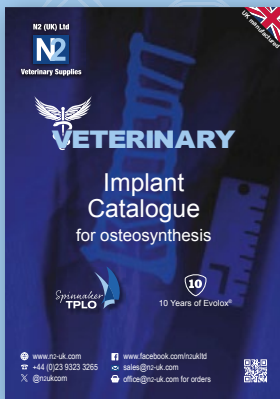

Implant catalogue



Instrument catalogue

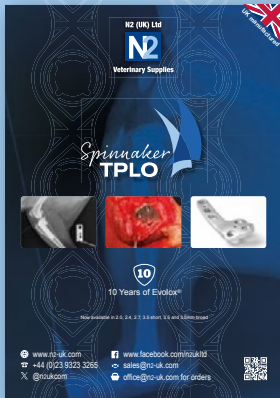

Spinnaker brochure

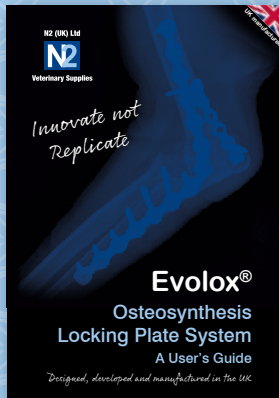

Evolox® user's guide



Consumable catalogue

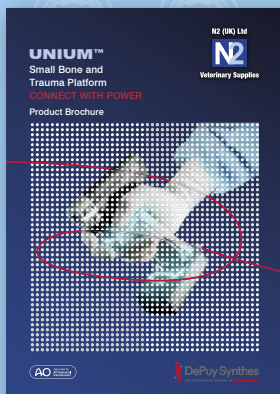

Unium catalogue



Synthes catalogue

- www.n2-uk.com
- +44 (0)23 9323 3265
- @n2ukcom
- www.facebook.com/n2ukltd
- sales@n2-uk.com
- office@n2-uk.com for orders